

WERKZEUG, DAS SICH EINBRENNT.















WERKZEUGKATALOG

2023





EINFACH VIGOR.

	Werkstattwagen und Betriebseinrichtung	→ 26–83
	Werkzeugaufbewahrung	→ 84–115
	Handwerkzeuge	→ 116–227
	Drehmoment-Werkzeuge	→ 228–229
	Pneumatik-Werkzeuge	→ 230–237
	Allgemeiner Werkstattbedarf	→ 238–250
	Diagnose / Batterie / Elektrik	→ 251–255
	Motor / Kühlung / Klima	→ 256–267
	Öldienst	→ 268–273
	Bremsen	→ 274–291
	Räder / Reifen	→ 292–303
	Karosserie	→ 304–313
	Kfz / Nfz Fahrwerk Spezial-Werkzeug	→ 320–415

Werkstattwagen mit Sortiment	29–41	Servicewagen	52	
Mobile Werkbank mit Sortiment	42–43	Zubehör für Werkstattwagen	53–61	
Werkstattwagen ohne Sortiment	44–49	Schrankwand-System	63–73	
Mobile Werkbank ohne Sortiment	50–51	Zubehör Schrankwand-System	74–83	
<hr/>				
Multiboxen	86–87			
Weichschaum-Einlagen	88–115			
<hr/>				
Steckschlüssel Systeme	118–173	VDE Werkzeuge	209–212	
Universal Werkzeugkoffer	174–175	Schlag-, Schaber- und Lösewerkzeuge	213–220	
Schraubenschlüssel	176–183	Diverse Handwerkzeuge	220–221	
Schraubendreher und Bits	184–195	Schneiden und Sägen	221–227	
Zangen	196–208			
<hr/>				
Drehmomentschlüssel	229			
Drehwinkel-Messgerät	229			
<hr/>				
Schlagschrauber	231–232			
Luftratschen	233			
Stabschleifer	234			
Pneumatik-Pistolen	235–237			
<hr/>				
Video-Endoskop	252			
Elektrik	253, 255			
Multimeter	253			
Kabelentriegelung	254			
Crimpzangen Satz	255			
<hr/>				
Motor-Werkzeuge	257–259			
Kühlsystem-Diagnose	260–262			
Turbosystem-Diagnose	263–264			
Kompressions- und Druckverlusttester	265–267			
<hr/>				
Öl-Messstäbe	269			
Ölfilter-Spannschlüssel	270–271			
Öl-Pumpen und Einfüllgeräte	272–273			
<hr/>				
Bremswartung und Entlüftung	275–277			
Bremskolben-Rückstellwerkzeuge	278–281			
Brems Scheiben-Werkzeuge	282–283			
Bördelgeräte	284–286			
Inspektions-Werkzeuge	287–291			
<hr/>				
Schlagschrauber-Krafteinsätze	293–295			
Wagenheber und Böcke	296–299			
Räder / Reifen-Werkzeuge	299–303			
<hr/>				
Scheibenwischerarm-Abzieher Satz	306			
Reparatur- und Einbausätze	307			
Induktionsheizgerät und Zubehör	308–313			
<hr/>				
Kfz-Fahrwerk Diverse	314–319	Werkzeugsätze Standard-Radlager	332–334	Werkzeugsätze Lager und Buchsen
Druck- und Zugzylinder	322–324	Werkzeugsätze Kompakt-Radlager	335–336	Federspanner
Zubehör Zylinder	325–328	Werkzeugsätze geschraubte Kompakt-Radlager	337–345	Mobile Werkbänke mit Spezialwerkzeug-Sortiment
Mechanischer Antrieb	329–330	Werkzeugsätze Radnabe mit 6- und 8- Bolzen	344	Spezial Weichschaum-Einlagen
	362–363	Werkzeugsätze Antriebswellen	346	Werkzeugsätze Nfz
Hydraulik-Pumpen	331	Multiboxen	347–361	394–415



Erklärung Antriebssymbole

	Für Schlitz-Schrauben
	Für Kreuzschlitz-Schrauben (PH)
	Für Pozidriv-Schrauben (PZ)
	Für Innensechskant-Schrauben
	Für Außensechskant-Schrauben
	Für Innen Sechsrund Schrauben
	Für Tamper Resistant Sechsrund Schrauben (Innen Sechsrund Schrauben mit Zapfenführung)
	Für Außen Sechsrund Schrauben
	Für Innenvielzahn-Schrauben (XZN)
	Für Innenkeilprofil-Schrauben
	Für Polydrive-Schrauben
	Für Innen-5-Stern-Schrauben mit Zapfen
	Für Tri-Wing® Schrauben
	Nenngröße 6,3 mm
	Nenngröße 10 mm
	Nenngröße 12,5 mm
	Nenngröße 20 mm
	Nenngröße 25 mm
	Innen-Vierkant
	Außen-Vierkant
	Innen-Sechskant
	Außen-Sechskant
	EN/IEC 60900:2004

Erklärung der Piktogramme

	Kfz Werkzeug
	LKW Werkzeug
	Betriebsanleitung / Anwendungshinweis
	Zentralverriegelung
	Gewicht Werkstattwagen
	Traglast Werkstattwagen
	Teiligkeit
	Zähne
	Drehwinkel
	Bohrungen
	Wellen
	Magnet
	Leuchtdauer
	Ladezeit
	Gewicht
	Batterietyp
	Akkustisches Signal
	Betriebsdruck
	Vibration
	U/min
	Lautstärke
	Max. Lösemoment
	Doppelhammerschlagwerk
	Kupplungsstecker-Nennweite
	Batterietyp
	Prüfgeräte
	SUV/Van
	Landmaschinen
	Industrie
	QR-Code
	Anwendungsvideo
	Schlauchlänge
	Ölinhalt
	Hydraulische Nutzung
	Mechanische Nutzung

A

Abisolierzange	212
Abzieher / Auszieher	258, 306, 317, 319, 341–342, 344–345, 364–365, 370, 403, 407, 409–410, 412
Adapter / Verbindungsstück	127, 138–140, 161, 165, 168, 264, 276, 327–328, 363, 377
Achsen Werkzeug	317
Antriebswelle Werkzeug	333, 343, 346, 358, 362–363, 387, 391, 399, 404–410
Arbeitslampe / -leuchte	246
Arbeitsplatte	58, 76–77
Aufsatzkoffer	45
Ausblaspistole	235–236
Austreiber	214, 217
Auswuchtgewichtzange	300
Autolichtprüfer	253, 255

B

Bandmaß	220
Biegsamer Schraubendreher	188
Bits und Schraubendreher	93, 97, 101–103, 112, 121, 124–125, 127, 134–140, 142–145, 154–161, 184–195, 210–211
Bockrolle	56
Bohrer	225
Bördelgerät	284–287, 289
Brecheisen	218–220, 300
Bremsen Werkzeug	275–278, 280–291, 346, 393, 403, 412
Bürste	215, 217, 225–227, 247

C

Crimpzange	255
Cuttermesser	222–223

D

Diagnose	211, 220–221, 229, 253, 255, 258, 260, 262–266, 269, 283, 288, 300
Doppel-Maulschlüssel	91, 176
Doppel-Ratschen-Ringschlüssel	182–183
Doppel-Ringschlüssel	92, 178, 180–182
Doppelgelenkzange	93, 196–198
Dosenhalter	55, 59
Drahtbürste	225
Drehgriffknarre	122, 131, 151
Drehmoment Werkzeug	229
Drehwinkel-Messgerät	229
Druck-Hydraulikzylinder	322–326, 358, 386, 391
Druckluft Werkzeug	90, 96–97, 113, 231–237, 295
Druckspindel	326, 329
Druckverlust- / Kompression-Tester	265–266
Durchtreiber	94, 214, 217

E

Eckunterschrank	71
Einlegeboden	58
Elektriker Werkzeug	95, 98, 209–212

F

Fahrgriff	55, 59
Fahrwerk Werkzeug	285, 288, 293–294, 300–303, 314–315, 317–319, 332–348, 351–354, 356–358, 362–363, 366–373, 377, 387, 390–391, 393, 396–399, 401–410, 412–413
Fäustel	213
Federbolzen Werkzeug	411, 414–415
Federspanner	375, 377
Feile	95, 224, 287
Feinzahnknarre	120–121, 131, 150–151, 167
Fingerratsche	121
Flachmeißel	214, 217
Flachrundzange	196–197, 207, 212
Flachschlüssel	102
Flaschenwagenheber	298
Flexible / schwenkbare Verlängerung	126, 139, 160
Flexibler Schraubendreher	188
Flügelürschrank	71–72
Fühlerlehre	220
Führungsschiene	57

G

Gabel-Ringschlüssel	91, 102–103, 112
Gabelschlüssel	91–92, 102–103, 112, 181, 183
Gaslötkolben	242
Gelenk Ratschen-Ring-Maulschlüssel	92, 181
Gelenkgriff	150
Gelenkwelle-Abzieher	317
Gleitgriff / Gleitstück	122, 152, 165
Gripzange	94, 203
Gummihammer	301

H

Hammer	94, 98, 112–113, 213, 301, 363
Hängeschrank	72
Hebeleisen	218–220, 300
Holz-Arbeitsplatte	58
HSS Bohrer	225
Hydraulikpumpe und Zubehör	331
Hydraulikwagenheber	296–297
Hydraulikzylinder	322–326, 358, 386, 391

I

Induktionsheizgerät und Zubehör	308–312
Injektorschacht Reinigung	267
Innenkeil (Ribe CV) Werkzeug	98, 144–145, 157–158
Innensechskantprofil Werkzeug	91, 125, 130, 136–138, 144, 149, 154, 159–160, 210
Inspektions Werkzeug	287, 290

J

Japanspachtel	240
---------------------	-----

K

Kabelentriegelung	254
Karosserie Werkzeug	306–312

K

Keilrippenriemen Werkzeug	259
Kfz Werkzeug	253–255, 314, 318–319, 332–345, 347–348, 351–353, 377, 387, 390, 393, 396–399, 401–402, 406, 408, 412
Kfz-Elektrik / -Elektronik	253–255
Kfz-Fahrwerk / Spurstange / Stoßdämpfer	314, 341–342, 344–345, 377
Klappmesser	222–223
Klebegewicht Werkzeug	300, 302
Klemmschrauben Werkzeug	315
Knarre / Knarrenschlüssel	92, 120–122, 131, 150–151, 165, 167, 169–170, 178–179, 181–182, 209
Knarren-Ring-Maulschlüssel	92, 178–179, 181
Knarrenkasten	118–120, 128–129, 141, 146, 165, 167, 169–173, 209, 295
Kniebrett	245
Koffer	86–87, 169–170, 174–175, 347–348, 351–354, 356–358, 393, 401–402
Kombizange	196, 207, 212
Kompakt-Radlager Werkzeug	336, 340–343, 345, 348–349, 351–353, 390, 392–393
Kompressions- und Druckverlust-Tester	265–266
Körner	214, 216
Kraftschrauber und -Einsätze	90, 96–97, 113, 147–148, 162–163, 166, 168, 231–232, 293–295
Krallengreifer	241
Kreuzmeißel	214, 216
Kreuzschlitz (PH) Werkzeug	125, 134, 184, 186, 211
Kugelgelenk Abzieher	364–365, 370, 403
Kühlsystem-Diagnose	260, 262
Kunststoffhaube	58
Kunststoffreparatur Werkzeug	307

L

Lager- und Buchsen Werkzeug	338–339, 350, 354, 356–357, 359–361, 364–373, 396–400, 403, 412–413
Lagerinnenring Abziehwerkzeug	319
Lambdasonde Werkzeug	257
Lampe / Leuchte	246
Laptop-Tisch	52–54
Laufbühne / Leiter	250
Lenkradeinstellwaage	301
Lenkrolle	56
Lochwandplatte	78, 82
Lösehebel	218–220, 300
LötKolben	242
Luftratsche / -schrauber	233, 295

M

Magnetheber	241
Manometer	328
Maulschlüssel	91–92, 102–103, 112, 178–179, 181
Mehrzweckwanne	242
Mechanische Spindel	326, 329
Meißel	94, 98, 112–113, 214
Messen / Prüfen	211, 220–221, 229, 253–255, 258, 260, 262–266, 269, 283, 287–288, 290, 300
Messer / Schere	221–223, 225
Mobile Werkbank	42–43, 50–51, 379–385
Montagehebel	300
Montagewagen	29–41, 44–59, 61
Motor Werkzeug	257–259, 262–265, 267
Multiboxen	86–87, 347–354, 356–361, 392–393, 400–402
Multimeter / Messkabel	253
Multiprofil Werkzeug	120, 124, 146, 154
MultiTool	239

N

Nfz Werkzeug	403–415
Nietzange	205–206
Nuss / Stecknuss	89–90, 95, 97, 99–101, 111, 118–148, 150–163, 165–173, 192, 209–210, 293–295
Nusskasten	118–120, 128–129, 141, 146, 165, 167, 169, 171–173

Ö

Öldienst Werkzeug	242, 269–273
-------------------	--------------

P

Papierrollenhalter	54
Pinzette	241
Pneumatik Werkzeug	90, 96–97, 113, 231–237, 295
Pozidriv (PZ) Werkzeug	125, 134
Prüfen / Messen	229, 253, 265–266, 287, 290

R

Räder- / Reifen Werkzeug	293–294, 300–303
Radlager Werkzeug Kfz	318–319, 332–345, 347–348, 351–353, 387–390, 393, 396–399, 401–402, 406, 408, 412
Rangierwagenheber	296–299
Ratsche / Ratschenschlüssel	92, 120–122, 131, 150–151, 165, 167, 169–170, 178–179, 181–183, 209
Ratschen-Ring-Maulschlüssel	92, 105, 178–179, 181
Ratschenkasten	118–120, 128–129, 141, 146, 165, 167, 169–173, 209, 295
Refraktometer	262
Regalboden	78–79
Reifenheber	300
Ribe CV Werkzeug	98, 144–145, 157–158
Ring-Maulschlüssel	91, 102–103, 106, 112, 177
Ringschlüssel	92, 178–182
Rohrschneider	225
Rollbrett	87
Rundfeile	224
Rundzange	212

S

Säge	221–222
Satz / Sortiment	89–103, 111–114, 118–120, 129, 141–144, 146, 165–169, 171–173, 181, 185–187, 189–192, 199, 203, 209, 211, 215, 217–220, 225, 240–242, 247, 255, 257–260, 263–264, 266–267, 269, 273, 275, 277, 285–286, 291, 295, 298–300, 306–307, 314–315, 325–326, 329, 333–335, 337, 343, 352–354, 356–357, 363, 369–371, 387, 390–391, 393, 404–405, 407–408, 411–415
Saugheber	249
Seegeringzange	96, 198–202, 204, 259, 330
Seitenschneider	196, 207–208, 212
Servicewagen	52
Schaber	94–95, 215, 217
Schaummatte	58
Scheibenwischarm-Abzieher	306
Schere / Messer	221–223, 225
Schiebestück	139
Schieblehre	221
Schlagschrauber und -Einsätze	90, 96–97, 113, 147–148, 162–164, 166, 168, 231–232, 293–295

S

Schlauchschellen-Zange	204, 259
Schleifen / Trennen / Zerspanen	95, 221–225, 234, 248, 250, 287
Schlitzprofil Werkzeug	125, 134, 184, 210
Schloss	57
Schlosserhammer	213
Schmierer / Reinigen / Pflegen	237
Schonhammer	213, 301
Schrankwand-System	60, 63–83
Schraubenausdreher	146–147, 162
Schraubendreher und Bits	90–91, 93, 95, 97, 101–103, 106, 112, 121, 124–125, 127, 134–140, 142–145, 154–161, 184–195, 210–211
Schraubendreher-Einsatz	90–91, 101–102, 105, 124–125, 130, 134–138, 142–145, 148–149, 154–160, 210
Schraubenschlüssel	91–92, 102–103, 178–182
Schraubstock	61
Schubblade	57
Schubblade-Trennblech	55–56
Schubladenunterschrank	66–69
Schwenkbare / flexible Verlängerung	126, 139, 160
Sechsrund Werkzeug	90, 93, 98, 123–124, 130, 133–136, 143, 148, 153, 155–159, 169–170, 187, 189, 191
Sicherheits-Laufbühne	250
Sicherungsringzange	96, 198–202, 204, 259, 330
Silentlager- / Buchsen Werkzeug	354, 356–357, 366–369, 371–373, 413
Sortiment / Satz	89–103, 111–113, 118–120, 129, 141, 146, 165–173, 181, 185–187, 189–192, 199, 203, 209, 211, 215, 217–220, 225, 240–242, 247, 255, 257–260, 263–264, 267, 269, 273, 275, 277, 285–286, 291, 295, 298–300, 306–307, 314–315, 325–326, 329, 333–335, 337, 343, 347, 351–354, 356–358, 363, 369–371, 387, 390–391, 401–402, 404–405, 407–408, 411, 413–415
Spachtel	240
Spannungsprüfer	211
Spindel, mechanisch	326, 329
Spiralbohrer	225
Spiralnutenausdreher-Einsatz	146–147, 162
Splinttreiber	94, 214, 217
Sprengringzange	96, 198–202, 204, 259, 330
Stabschleifer	234
Steckgriff	122
Steckschlüssel System Kombination	104, 118, 169–173
Steckschlüsseleinsatz	89–90, 95–97, 99–101, 111, 113, 118–148, 150–163, 165–173, 192, 209–210, 282, 293–294
Stoßdämpfer Werkzeug	314, 316, 341–342, 344–345, 377

T

T-Griff Schraubendreher	103, 190–191
Tamper-Resistant Sechsrund Werkzeug	124, 134–136
Teleskopspiegel	240
Teppichmesser	222–223
Tiefenmesser	300
Traggelenk Werkzeug	315, 369–370, 403
Turbosystem-Diagnose	258, 263–264

U

Umschaltknarre	120–122, 131–132, 150–151, 165, 167, 209
Universalgelenk	125, 138, 160, 168
Universalzange	208
Unterstellbock und Wagenheber	296–299

V

Vakuum- und Druckpumpe	266, 272
VDE Werkzeug	95–96, 98, 209–212
Verbindungsstück / Adapter	114, 127, 138–140, 161, 165, 168, 264, 276, 327–328, 363, 377
Verlängerung	126, 138–139, 160–161, 166, 209
Vielzahn Werkzeug	91, 98, 143, 155
Vierkant Antrieb	
6,3 mm (1/4 Zoll)	89, 99–100, 111, 118–127, 140, 172–173
10 mm (3/8 Zoll)	127–140, 161, 174–175
12,5 mm (1/2 Zoll)	89, 99–100, 111, 126, 139–148, 150–163, 165–166, 172–173, 209–210, 233, 294–295
20 mm (3/4 Zoll)	165–167
VIGOR 1000	32–34, 42–43
VIGOR 1000 XD	40–41, 49
VIGOR 1000 XL	37–39, 47–48, 50–51
Vollstahlknarre	120–121, 131, 151
VSS – VIGOR Schrankwand System	60, 63–83

W

Wagenheber und Unterstell-Böcke	296–299
Wanne	242
Weichschaum-Einlage	89–114, 351, 386–387, 390–391
Werkbank und Zubehör	42–43, 50–51
Werkstatt-Einrichtung	60, 63–65, 67, 71–83, 242–246, 252, 318
Werkstattlampe / -leuchte	246
Werkstattwagen und Zubehör	29–41, 44–59, 61
Werkzeug für Kfz	253–255, 314, 318–319, 332–345, 347–348, 351–353, 377, 387, 390, 393, 396–399, 401–402, 406, 408, 412
Werkzeug für Nfz	403–415
Werkzeug-Organisation	29–61, 63–65, 67, 71–83, 89–103, 111–114, 351, 386–387, 390–391
Werkzeughaken	60
Werkzeugkoffer / -kasten	86–87, 169–170, 174–175, 347, 351, 354, 356–358, 393, 401–402
Winkelschraubendreher	103, 189

X

XZN Werkzeug	91, 98, 130, 143, 149, 155
--------------	----------------------------

Z

Zange	94, 96, 103, 112–113, 196–208, 212, 255, 259, 299–300, 330
Zubehör Hydraulikpumpe	328, 331
Zug-Hydraulikzylinder	322–324
Zündkerzen Werkzeug	133, 153, 197

VIGOR-No.	Seite	VIGOR-No.	Seite	VIGOR-No.	Seite	VIGOR-No.	Seite	VIGOR-No.	Seite	VIGOR-No.	Seite
V1008	179	V1461N-10X11	176	V1801	224	V1986	124	V2084	154	V2142	124
V1009	179	V1461N-12X13	176	V1802	203	V1987	124	V2085	154	V2143	133
V1010	179	V1461N-14X15	176	V1803	203	V1988	154	V2086	154	V2144	133
V1021	179	V1461N-16X17	176	V1804	203	V1989	154	V2087	154	V2145	133
V1022	179	V1461N-18X19	176	V1808	203	V1990	154	V2088	154	V2146	133
V1023	179	V1461N-20X22	176	V1897	120	V1991	154	V2089	154	V2149	135
V1025	179	V1461N-21X23	176	V1898	146	V1992	154	V2090	154	V2151	155
V1026	179	V1461N-24X27	176	V1901	45	V1993	154	V2091	154	V2152	155
V1027	179	V1461N-25X28	176	V1902	45	V1994	154	V2092	154	V2153	155
V1028	179	V1461N-30X32	176	V1903	57	V1995	154	V2094	155	V2154	155
V1029	179	V1524N	178	V1904	57	V1996	154	V2095	155	V2155	155
V1030	179	V1524N-6X7	178	V1905	57	V1997	154	V2096	155	V2156	155
V1031	179	V1524N-8X9	178	V1906	57	V1998	154	V2097	155	V2157	155
V1135	213	V1524N-10X11	178	V1907	56	V1999	154	V2098	155	V2158	155
V1138	211	V1524N-12X13	178	V1908	56	V2000	154	V2099	155	V2159	155
V1208	184	V1524N-14X15	178	V1909	58	V2001	154	V2100	155	V2160	155
V1209	184	V1524N-16X17	178	V1917	143	V2002	154	V2101	154	V2161	156
V1212	213	V1524N-18X19	178	V1918	143	V2003	154	V2102	154	V2162	156
V1213	215	V1524N-20X22	178	V1919	144	V2004	154	V2103	154	V2163	156
V1214	214	V1524N-21X23	178	V1963-1	261	V2014	127	V2104	154	V2165	156
V1215	214	V1524N-24X27	178	V1963-3	261	V2016N	132	V2105	154	V2167	156
V1216	214	V1524N-25X28	178	V1963-4	261	V2017N	132	V2106	154	V2168	156
V1217	214	V1524N-30X32	178	V1963-5	261	V2018N	132	V2107	154	V2169	156
V1218	214	V1571	301	V1963-6	261	V2019N	132	V2108	140	V2170	156
V1219	214	V1584	300	V1963-7	261	V2020N	132	V2109	161	V2171	156
V1220	214	V1637	185	V1963-8	261	V2027	211	V2110	161	V2172	156
V1221	214	V1657	300	V1963-9	261	V2028	210	V2111	165	V2173	156
V1222	214	V1698	184	V1963-10	261	V2029	210	V2112	269	V2174	156
V1281	270	V1699	184	V1963-11	261	V2030	210	V2113	155	V2175	156
V1283	215	V1700	184	V1963-12	261	V2059	155	V2114N	139	V2176	156
V1293	168	V1701	184	V1963-13	261	V2060	155	V2115N	138	V2177	156
V1301	220	V1702	184	V1963-14	261	V2061	210	V2116N	139	V2178	156
V1304	221	V1703	184	V1963-15	261	V2062	211	V2117N	138	V2179	156
V1345	223	V1704	184	V1963-16	261	V2063	211	V2118N	138	V2180	156
V1368N	215	V1706N	171	V1963-17	261	V2064	211	V2119N	133	V2181	156
V1369	218	V1707	225	V1963-18	261	V2065	155	V2120N	133	V2182	156
V1371	218	V1711-1	280	V1963-19	261	V2066	155	V2121	155	V2183	156
V1371-1	218	V1711N	280	V1963-20	261	V2067	155	V2122	155	V2184	156
V1371-2	218	V1713	221	V1963-21	261	V2068	155	V2123	155	V2185	123
V1371-3	218	V1714	220	V1963-22	261	V2069	154	V2124	155	V2186	123
V1371-4	218	V1715	221	V1963-23	261	V2070	154	V2126	155	V2187	123
V1371-5	218	V1722	253	V1963-24	261	V2071	140	V2128	155	V2188	123
V1371-6	218	V1728	285	V1963-25	261	V2072	154	V2129	155	V2189	123
V1372	215	V1740	241	V1963N	260	V2073	154	V2130N	124	V2194	134
V1409	190	V1741	241	V1970	46	V2074	154	V2132	155	V2195	134
V1410	191	V1764	241	V1976	124	V2075	154	V2133	155	V2196	153
V1423	301	V1781	169	V1977	124	V2076	154	V2134	155	V2197	153
V1426N	208	V1782	285-286, 289	V1979	124	V2077	154	V2135	155	V2201	144
V1438	241	V1783	214	V1980	124	V2078	154	V2136	124	V2202	157
V1446	223	V1787	224	V1981	124	V2079	154	V2137	155	V2203	157
V1447	223	V1788	224	V1982	124	V2080	154	V2138	124	V2204	157
V1461N	176	V1789	224	V1983	124	V2081	154	V2139	124	V2205	157
V1461N-6X7	176	V1790	224	V1984	124	V2082	154	V2140	124	V2206	157
V1461N-8X9	176			V1985	124	V2083	154	V2141	124	V2207	157

Nummern- / Seiten-Verzeichnis



VIGOR-No.	Seite	VIGOR-No.	Seite	VIGOR-No.	Seite	VIGOR-No.	Seite	VIGOR-No.	Seite	VIGOR-No.	Seite
V2208	157	V2283N	137	V2393-XD	55	V2453N	122	V2511N	270	V2586N	153
V2209	157	V2284N	137	V2394	225	V2454N	125	V2512	300	V2587N	153
V2210	157	V2285N	137	V2395	225	V2455N	126	V2513	300	V2588N	153
V2211	157	V2286N	134	V2396	225	V2456N	126	V2514	300	V2589N	153
V2212	157	V2287N	134	V2397	54	V2457N	126	V2515	300	V2590N	153
V2213	157	V2288N	134	V2400	175	V2458N	122	V2516	300	V2591N	153
V2214	157	V2289N	134	V2401	162	V2459N	262	V2517	60	V2592N	153
V2215	157	V2290N	134	V2402	162	V2460N	141	V2518	60	V2593N	125
V2216	157	V2291N	134	V2403	162	V2461N	172	V2519	60	V2594N	125
V2217	157	V2292N	134	V2404	146	V2462	57	V2520	60	V2595N	124
V2218	157	V2293N	134	V2405	162	V2464	175	V2521	270	V2596N	124
V2219	157	V2294N	134	V2406	162	V2465N	152	V2522	295	V2597N	125
V2220	157	V2295N	135	V2407	162	V2466	285	V2523	306	V2598N	152
V2221	157	V2296N	135	V2408	162	V2467	285	V2533N	123	V2599N	152
V2222	157	V2297N	135	V2409	162	V2471	295	V2534N	123	V2600N	152
V2223	157	V2298N	135	V2410	162	V2472	295	V2535N	123	V2603N	152
V2224	157	V2299N	135	V2413N	123	V2473	295	V2536N	123	V2613N	133
V2225	157	V2300N	135	V2414N	119	V2474	295	V2537N	123	V2614N	133
V2226	157	V2301N	135	V2415N	123	V2475	295	V2538N	123	V2615N	133
V2227	158	V2302N	135	V2416N	123	V2477	298	V2539N	123	V2616N	138
V2228	158	V2303N	135	V2417N	123	V2478	298	V2540	285	V2626	225, 285
V2229	158	V2305N	129	V2418N	123	V2481	296	V2542	175	V2627	222
V2230	158	V2311N	132	V2419N	123	V2482	191	V2551	285	V2628	212
V2231	158	V2312N	132	V2420N	123	V2483	191	V2552	285	V2629	212
V2232	158	V2313N	132	V2421N	123	V2484	191	V2553	285	V2630	212
V2233	158	V2314N	132	V2422N	123	V2485	191	V2554	285	V2631	296
V2234	301	V2315N	132	V2423N	123	V2486	190	V2555	285	V2632	296
V2235	301	V2316	246	V2424N	123	V2487	215	V2556	285	V2639	296
V2249	288	V2317N	166	V2425N	123	V2488	215	V2558	285	V2640	296
V2250	288	V2318N	165	V2426N	123	V2489	190	V2559	285	V2641	212
V2256N	166	V2319N	165	V2427N	125	V2490	191	V2561N	152	V2643	212
V2257	295	V2320N	166	V2428N	125	V2491	218	V2562N	152	V2645	269
V2261N	132	V2321N	166	V2429N	125	V2492	218	V2563N	152	V2647N	161
V2262N	132	V2322N	165	V2430N	125	V2493	218	V2564N	152	V2648	299
V2263N	132	V2323N	166	V2431N	125	V2494	218	V2565N	152	V2662	213
V2264N	132	V2324N	166	V2432N	125	V2495	218	V2566N	152	V2663	213
V2265N	132	V2325N	166	V2433N	125	V2496	142	V2567N	152	V2664	213
V2266N	132	V2326N	166	V2434N	125	V2497	191	V2568N	152	V2665	213
V2267N	132	V2327N	166	V2435N	125	V2498	191	V2569N	152	V2667N	152
V2268N	132	V2328N	166	V2436N	125	V2499	255	V2570N	152	V2683	314
V2269N	132	V2329N	166	V2437N	125	V2499-A	255	V2571N	152	V2684	314
V2270N	132	V2331N	166	V2438N	125	V2499-B	255	V2572N	152	V2687	169
V2271N	132	V2332N	166	V2439N	125	V2499-C	255	V2573N	152	V2699N	123
V2272N	132	V2333N	166	V2440N	125	V2499-D	255	V2574N	152	V2700N	123
V2273N	132	V2334N	166	V2441N	125	V2499-F	255	V2575N	160	V2701N	123
V2274N	132	V2335N	166	V2442N	124	V2501	191	V2576N	160	V2705	182
V2275N	132	V2336N	166	V2443N	124	V2502	190	V2577N	160	V2712N	30
V2276N	132	V2337N	166	V2444N	124	V2503	190	V2578N	153	V2722	123
V2277N	132	V2338	245	V2445N	124	V2504	190	V2579N	153	V2723	123
V2278N	132	V2338-XL	246	V2446N	124	V2505	190	V2580N	153	V2724	133
V2279N	137	V2347	246	V2447N	124	V2506	190	V2581N	153	V2725	133
V2280N	137	V2379N	29	V2448N	189	V2507	190	V2582N	153	V2726	133
V2281N	137	V2393	55	V2450N	189	V2508	215	V2584N	153	V2727	133
V2282N	137	V2393-S	55	V2452N	127	V2509	215	V2585N	153	V2728	133

VIGOR-No.	Seite	VIGOR-No.	Seite	VIGOR-No.	Seite	VIGOR-No.	Seite	VIGOR-No.	Seite	VIGOR-No.	Seite
V2729	133	V2853	329	V2923	370	V3046	370	V3140	363	V3333	210
V2730	153	V2854	323, 352-353, 358	V2924N	166	V3047	370	V3141	331	V3334	210
V2731	153	V2858N	403	V2936	413	V3048	370	V3142	366	V3335	210
V2732	153	V2859	340	V2937	412	V3049	370	V3147	362	V3336	210
V2733	153	V2860	335, 351	V2941	122	V3050	372	V3148	362	V3337	210
V2734	153	V2861	340	V2942	413	V3051	372	V3149	396, 400-401	V3338	210
V2735	153	V2862	340	V2945	357	V3052	372	V3199	323	V3339	210
V2762	298-299	V2863	340	V2946	357	V3053	350, 366, 369	V3205	329	V3340	210
V2781	196	V2864	336, 351	V2947	356	V3055	366	V3206	329	V3341	209
V2782	196	V2867N	330, 414-415	V2948	356	V3055-275	367	V3207	326	V3342	209
V2783	197	V2869	322, 355	V2949	356	V3056	350, 361, 366, 369	V3208	326, 373	V3343	209
V2788	206	V2871	363	V2950	356	V3057	366	V3209	326	V3344	210
V2788-3.2	206	V2872	363	V2961	356	V3060	333-334	V3210	326	V3366	187
V2788-4.0	206	V2873	322	V2962	356	V3070	334	V3212	371	V3367	187
V2788-6.4	206	V2874	324, 414-415	V2963	356	V3071	334	V3213	371	V3368	187
V2788-4.8	206	V2879	398	V2964	356	V3087	401	V3214	371	V3369	187
V2789N	287	V2881	396, 401	V2965	356	V3088	401	V3215	371	V3370	187
V2790N	222	V2882	396, 401	V2966	356	V3090	402	V3216	324	V3381	259
V2795	229	V2883	396-397, 401	V2967	356	V3091	396, 401	V3217	322	V3391	187
V2804	181	V2885	355, 366	V2968	356	V3092	324, 408	V3219	326, 373	V3392	187
V2805	181	V2886	371	V2969	356	V3100	371	V3220	326, 373	V3393	187
V2806	181	V2889	396	V2971	356	V3101	371	V3222	407, 414-415	V3403	369
V2807	181	V2890	399, 402	V2972	356	V3102	371	V3224	413	V3404	369
V2808	181	V2891	367	V2973	356	V3103	371	V3225	413	V3405	369
V2809	181	V2892	367	V2974	356	V3105	396	V3226	413	V3427N	191
V2810	181	V2893	355, 367	V2975	357	V3106	396, 400-401, 413	V3227	413	V3431	408, 413
V2811	181	V2894	355, 367	V2976	357	V3107	396, 413	V3231	407	V3433	397, 401
V2812	181	V2895	355, 367	V2977	357	V3108	396, 400-401	V3232	404, 407	V3434	408
V2813	181	V2896	367	V2978	357	V3109	396, 401	V3233	412	V3437	408
V2814	181	V2897	355, 367	V2979	357	V3110	401	V3234	412	V3438	408
V2817	181	V2898	355, 367	V2980	357	V3112	331	V3235	412	V3439	408
V2818	181	V2899	355, 367	V2981	357	V3123	323	V3236	412	V3440	408
V2820	179	V2900	355, 367	V2992	330	V3124	322-323	V3237	412	V3441	229
V2821	178	V2901	355, 367	V2993	330	V3125	323	V3238	413	V3451	225
V2822	178	V2902	367	V2994	330	V3126	323, 326, 329, 363, 412	V3259	411	V3541	213
V2823	178	V2903	355, 367	V2999	370	V3127	323, 326, 412	V3260	411	V3551N	307
V2824	178	V2904	367	V3000	370	V3128	322-324	V3261	411	V3551N-ABS	307
V2825	178	V2905	367	V3001	370	V3129	323, 355, 370	V3262	411	V3551N-PE	307
V2826	178	V2906	367	V3002	370	V3130	323-324	V3263	407, 410-411	V3551N-PP	307
V2827	178	V2907	367	V3008	329	V3131	324	V3264	404, 407	V3551N-PS	307
V2828	178	V2908	367	V3009	322	V3132	324, 326, 408	V3265	404, 407	V3551N-W	307
V2828	178	V2909	367	V3010	322	V3133	324, 326	V3266	404-405, 412-413	V3562	185
V2829	178	V2910	327	V3011	322	V3134	323	V3267	404-405, 412-413	V3563	300
V2829	178	V2912	368	V3012	322	V3135	326, 372	V3275	326	V3571	259
V2830	178	V2913	370	V3013	399, 402	V3136	326, 372	V3277N	173	V3582	328
V2831	178	V2914	370	V3018	323-324	V3137	326, 372	V3287	399, 402	V3597	184
V2832	178	V2915	370	V3021	402	V3140	363	V3309	225	V3598	184
V2833	178	V2917	372	V3033	363	V3141	331	V3330	210	V3599	184
V2837	100	V2919	327	V3035	363	V3142	366	V3331	210	V3600	184
V2838	100	V2920	403	V3036	363	V3147	362	V3332	210	V3601	184
V2845	332	V2922	363, 395	V3039	332, 401	V3148	362	V3333	210	V3602	184
V2846	331, 353			V3040	332, 401	V3149	396, 400-401	V3334	210	V3607	182
V2847	331, 352			V3044	372	V3199	323	V3335	210	V3609	184
V2849	358, 362			V3045	370	V3205	329	V3336	210	V3610	184
V2850	327					V3206	329	V3337	210		
V2851	327					V3207	326	V3338	210		

Nummern- / Seiten-Verzeichnis



VIGOR-No.	Seite	VIGOR-No.	Seite	VIGOR-No.	Seite	VIGOR-No.	Seite	VIGOR-No.	Seite	VIGOR-No.	Seite
V3612	328	V3746	162	V3763	410	V4230	103	V4381-4	276	V4472N	177
V3613	184	V3747	162	V3764	410	V4231	103	V4383	273	V4473N	177
V3614	331	V3750	410	V3765	410	V4233	263	V4384	273	V4473N-6	177
V3615	300	V3753	337, 348-349	V3863	314	V4235	213	V4385N	273	V4473N-7	177
V3634	408	V3755	335	V3867	409	V4241	239	V4398N	160	V4473N-8	177
V3635	179	V3758	337, 348-349	V3869	327	V4242	324	V4399	283	V4473N-9	177
V3636	179	V3760-0	279	V3870	327	V4243	325	V4411	275	V4473N-10	177
V3649	350, 369	V3760-0-DISC	279	V3871	332, 335, 337, 343, 346, 359	V4244	325	V4413	271	V4473N-11	177
V3650	369	V3760-A	278	V3873	332, 335, 337, 343	V4245	325	V4414	271	V4473N-12	177
V3651N	127	V3760-A1	279	V3874	332, 335, 337, 343	V4246	325	V4415	271	V4473N-13	177
V3652N	140	V3760-B	278	V3898	229	V4248	315	V4416	284	V4473N-14	177
V3653	232	V3760-B1	279	V3899	229	V4249	315	V4416-1	284, 286	V4473N-15	177
V3657	299	V3760-C	278	V4111	57	V4250	315	V4416-2	284, 286	V4473N-16	177
V3661	314	V3760-D	278	V4112	57	V4251	324	V4416-3	284, 286	V4473N-17	177
V3670N	307	V3760-E	278	V4113	273	V4252	324	V4416-4	284, 286	V4473N-18	177
V3671N	307	V3760-F	278	V4114	273	V4253	324	V4416-5	284	V4473N-19	177
V3672N	307	V3760-F1	279	V4115	273	V4254	324	V4418	187	V4473N-20	177
V3673N	307	V3760-G	278	V4122	58	V4255	331	V4419	187	V4473N-21	177
V3676N	307	V3760-H6	279	V4126N	315	V4257	261	V4420	187	V4473N-22	177
V3677N	307	V3760-H7	279	V4130	99	V4258	261	V4421	187	V4473N-24	177
V3678	403	V3760-IV	279	V4153	306	V4274	222	V4422	187	V4473N-27	177
V3680	351	V3760-J	278	V4154	306	V4275	222	V4425N	174	V4473N-30	177
V3681	273	V3760-K	279	V4155	306	V4278	240	V4432/6	186	V4473N-32	177
V3682	273	V3760-K1	279	V4156	306	V4279	240	V4433	186	V4473N-36	177
V3683	273	V3760-K2	279	V4157	306	V4303	190	V4434	186	V4476-1	377
V3684	273	V3760-M	279	V4158	306	V4304	264	V4435	186	V4476N	375
V3685	273	V3760-N	279	V4159	306	V4305	264	V4436	186	V4477	163
V3686	273	V3760-P	279	V4160	306	V4306	264	V4437	186	V4478	163
V3687	273	V3760-P1	279	V4161	306	V4308	222	V4438	186	V4481	47
V3688	273	V3760-Q	279	V4163	306	V4309	293	V4451	254	V4481-X	48
V3689	273	V3760-R	279	V4164	306	V4310N	219	V4451-1	254	V4481-X-4	55
V3690	273	V3760-S	279	V4165	306	V4311	126	V4451-2	254	V4481-X-5	59
V3691	273	V3760-T	279	V4188	99	V4312	126	V4451-3	254	V4481-X/375	37
V3729	261	V3760-V	279	V4192	263	V4313	126	V4451-4	254	V4481-X/466	38
V3731	337	V3760-VW	279	V4196	205	V4314	139	V4451-5	254	V4481-X/499	39
V3732	337	V3760-X	279	V4199	192	V4315	139	V4451-6	254	V4481-XD	49
V3734N	118	V3760-Z	279	V4200	192	V4316	139	V4451-7	254	V4481-XD-1	57
V3735	206	V3760-1	278	V4201	272	V4317	160	V4451-8	254	V4481-XD-2	57
V3735-M10	206	V3760-2	278	V4201-1	272	V4318	160	V4451-9	254	V4481-XD-3	57
V3735-M5	206	V3760-3	278	V4202	261	V4319	160	V4451-10	254	V4481-XD-4	55
V3735-M6	206	V3760-4	278	V4218	325	V4322	237	V4451-11	254	V4481-XD-5	59
V3735-M8	206	V3760-5	278	V4219	31	V4324	253	V4451-12	254	V4481-XD/469	40
V3735-4.0	206	V3760-6	278	V4220	328	V4324-1	253	V4451-13	254	V4481-XD/775	41
V3735-3.2	206	V3760-7	278	V4221	192	V4324-2	253	V4451-14	254	V4491	343
V3735-6.4	206	V3760-8	279	V4222	192	V4325	266	V4451-15	254	V4493	343
V3735-4.8	206	V3760-9	279	V4223	192	V4342	326	V4451-16	254	V4499	409
V3738	203	V3760-11	278	V4224	192	V4352	377	V4451-17	254	V4500	409
V3738-S	203	V3760-12	278	V4225	192	V4353	377	V4451-18	254	V4521	111
V3739	203	V3760N	278	V4227	239	V4354	377	V4451-19	254	V4542	35
V3741	147	V3761	409	V4228	239	V4369	272	V4451-20	254	V4545	405, 407
V3742	162	V3762	409	V4229	324	V4381	276	V4451-21	254	V4546	405, 407
V3743	162					V4381-1	276	V4451-22	254	V4547	405, 407
V3744	162					V4381-2	276	V4451-23	254	V4548	405, 407
V3745	162					V4381-3	276	V4461	265	V4549	405, 407

VIGOR-No.	Seite	VIGOR-No.	Seite	VIGOR-No.	Seite	VIGOR-No.	Seite	VIGOR-No.	Seite	VIGOR-No.	Seite
V4550	404-405	V4608	406	V4655	185	V4891-3	308	V4941N-11	267	V5027	341, 345, 349, 360
V4551	323	V4609	406, 411	V4661	213	V4891-4	308	V4941N-19T	267	V5042	184
V4552	323	V4610	406	V4661-1	213	V4891-5	309	V4941N-20	267	V5043	184
V4553	323	V4614	333, 348	V4663	215	V4891-6	309	V4941N-22	267	V5044	184
V4554	407	V4629	332, 347	V4664	188	V4891-7	309	V4941N-245	267	V5045	215
V4555	407	V4629-1	332, 348	V4665	188	V4891-8	309	V4942	189	V5048	269
V4556	407	V4631	114	V4666	188, 415	V4891-9	309	V4944-REP	121	V5055	32
V4560	33	V4632	114	V4667	184	V4891-10	309	V4944-S	121	V5058	386
V4561	34	V4633	114	V4668	275	V4891-10.0	312	V4944-XS	121	V5058-L	386
V4562	404-405	V4634	404-405	V4680	351-353, 360	V4891-3.5	310	V4945-REP	131	V5062	387
V4563	404-405	V4635	412	V4690	221	V4891-3.5-1	311	V4945-S	131	V5062-L	387
V4564	404-405	V4636N	319	V4697	284	V4891-3.5-2	311	V4946-REP	151	V5064	386
V4565	404, 414	V4637N	204	V4697-1	284	V4891-3.5-3	311	V4946-S	151	V5066	391
V4566	405	V4638	250	V4697-2	284, 286	V4891-3.5-4	311	V4961	179	V5066-L	391
V4569	406	V4641	204	V4699	329	V4891-3.5-5	311	V4962	179	V5068	93
V4570	406	V4642	317	V4699-1	329	V4891-3.5-6	311	V4963	179	V5068-L	93
V4571	406	V4646	247	V4699-2	329	V4891/6	309	V4964	179	V5070	94
V4572	406	V4646M-8	247	V4699-3	329	V4893	59	V4965	179	V5070-L	94
V4573	406	V4646M-9	247	V4699-4	329	V4904	391	V4966	179	V5072	95
V4574	406	V4646M-10	247	V4699-5	329	V4904-L	391	V4971	89	V5072-L	95
V4575	406	V4646M-11	247	V4699-6	329	V4906	390	V4971-L	89	V5075	92
V4577	409	V4646M-12	247	V4699-7	329	V4906-L	390	V4973	89	V5075-L	92
V4586	111	V4646M-13	247	V4700-A	87	V4906N	390	V4973-L	89	V5077	92
V4594	334	V4646M-14	247	V4700-L	86	V4906N-L	390	V4975	89	V5077-L	92
V4594-1	334	V4646M-15	247	V4700-R	87	V4908	387	V4975-L	89	V5081	97
V4596	326	V4646M-16	247	V4700-XL	86	V4908-L	387	V4987	92	V5081-L	97
V4597	326	V4646M-17	247	V4700-XXL	87, 355	V4915	387	V4987-L	92	V5085	98
V4598	333, 347	V4646M-18	247	V4701	272	V4915-L	387	V4989	93	V5085-L	98, 386
V4598-2	333, 348, 363	V4646M-19	247	V4708	189	V4921	387	V4989-L	93	V5087	98
V4598-3	333-334, 348	V4646N-8	247	V4709N	152	V4921-L	387	V4991	93	V5087-L	98
V4598-4	333, 348	V4646N-9	247	V4726	101	V4930	283	V4991-L	93	V5091	91
V4598-10	333	V4646N-10	247	V4727	101	V4941N	267	V4995	93	V5091-L	91
V4598-11	333	V4646N-11	247	V4728	102	V4941N-BK	267	V4995-L	93	V5095	90
V4598-12	333-334	V4646N-12	247	V4729	102	V4941N-BL	267	V4999N	96	V5095-L	90
V4598-13	333	V4646N-13	247	V4737	204	V4941N-M5	267	V4999N-L	96	V5097	91
V4598-14	333	V4646N-14	247	V4752	101	V4941N-R1	267	V5004	94	V5097-L	91
V4598-15	333	V4646N-15	247	V4753	101	V4941N-R10	267	V5004-L	94	V5099	90
V4598-16	333	V4646N-16	247	V4758	52	V4941N-R11	267	V5006	94	V5099-L	90
V4598-20	333	V4646N-17	247	V4800N	231	V4941N-R12	267	V5006-L	94	V5103	97
V4598-21	333	V4646N-18	247	V4813	50	V4941N-R13	267	V5009	114	V5103-L	97
V4598-22	333	V4646N-19	247	V4813-1	58	V4941N-R2	267	V5011	95	V5109	101
V4598-30	333-334, 348	V4646S-8	247	V4813-2	58	V4941N-R3	267	V5011-L	95	V5109-L	101
V4599	334	V4646S-9	247	V4814	51	V4941N-R4	267	V5013	95	V5111N	108
V4601	411	V4646S-10	247	V4814-1	57	V4941N-R5	267	V5013-L	95	V5111N-L	108
V4602	411	V4646S-11	247	V4814-2	56	V4941N-R6	267	V5015	96	V5115	100
V4602-1	411	V4646S-12	247	V4814-3	56	V4941N-R7	267	V5015-L	96	V5115-L	100
V4603	414	V4646S-13	247	V4814-4	58	V4941N-R8	267	V5017	95	V5128	347
V4604	415	V4646S-14	247	V4884	150	V4941N-R9	267	V5017-L	95	V5156	42
V4605	406	V4646S-15	247	V4884-01	150	V4941N-1	267	V5018	114	V5158	43
V4606	406	V4646S-16	247	V4885	219	V4941N-2	267	V5019	193	V5168	358
V4607	406	V4646S-17	247	V4891	308	V4941N-3	267	V5020	194	V5169	356
		V4646S-18	247	V4891-1	308	V4941N-4	267	V5024	166	V5169-A	357
		V4646S-19	247	V4891-2	308	V4941N-5	267	V5025	166	V5169-A45	357
		V4651	222			V4941N-10	267	V5026	166		

Nummern- / Seiten-Verzeichnis



VIGOR-No.	Seite	VIGOR-No.	Seite	VIGOR-No.	Seite	VIGOR-No.	Seite	VIGOR-No.	Seite	VIGOR-No.	Seite
V5169-A55	357	V5505-1/4	168	V5637N	109	V6000-3P2	64	V6000-054	81	V6029-2	297
V5169-A70	357	V5505-3/8	168	V5637N-L	109	V6000-3P2XL	64	V6000-055	82	V6029-3	297
V5169-A76	357	V5512	242	V5638N	112	V6000-3P2XL-X	64	V6000-055XL	82	V6030	217
V5169-A80	357	V5513	286	V5638N-L	112	V6000-04	72	V6000-0676	76	V6030-12	217
V5170	112	V5513-1	286	V5639	208	V6000-04XL	73	V6000-0676-D	77	V6030-16	217
V5170-L	112	V5513-2	286	V5649	287	V6000-05	78	V6000-0676-X	76	V6030-20	217
V5175	103	V5513-3	286	V5650	196	V6000-05S	78	V6000-0676-XD	77	V6031	297
V5175-L	103	V5531	249	V5660	262	V6000-05SP	78	V6000-0860	76	V6031-1	297
V5180	52, 56	V5548	393	V5661	188	V6000-05SXL	78	V6000-0860-X	76	V6031-2	297
V5182	166	V5548-L	393	V5671N	231	V6000-09	79	V6000-0861	76	V6031-3	297
V5183	166	V5549	348	V5672	234	V6000-010	79	V6000-0861-D	77	V6038	131
V5191	52, 56	V5549-1N	349	V5673	234	V6000-011	71	V6000-0861-X	76	V6038-REP	131
V5202	118	V5550L	148	V5674	233	V6000-015	78	V6000-0861-XD	77	V6039	167
V5202-1	122	V5550L-10	162	V5675	233	V6000-015S	78	V6000-01083-D	77	V6048	183
V5202-2	127	V5550L-11	162	V5676	257	V6000-015SP	78	V6000-01083-XD	77	V6049	183
V5202-4	123	V5550L-12	162	V5677	242	V6000-015SXL	78	V6000-01357	76	V6068	194
V5202-5	123	V5550L-13	162	V5678	243	V6000-017	78	V6000-01357-D	77	V6082	135
V5202-6	123	V5550L-14	162	V5681	208	V6000-017XL	78	V6000-01357-X	76	V6083	135
V5202-7	123	V5550L-15	162	V5691	287	V6000-018	79	V6000-01357-XD	77	V6084	135
V5202-8	123	V5550L-16	162	V5741N	350	V6000-018XL	79	V6000-01541	76	V6085	135
V5202-9	123	V5550L-17	162	V5885	219	V6000-019	68	V6000-01541-X	76	V6086	135
V5202-10	123	V5550L-18	162	V5902	350, 371	V6000-019XL	68	V6000-01725	76	V6087	135
V5202-11	123	V5550L-19	162	V5902-1	371	V6000-020	80	V6000-01725-D	77	V6088	135
V5202-12	123	V5550L-21	162	V5902-2	371	V6000-029	66	V6000-01725-X	76	V6089	135
V5202-13	123	V5550L-22	162	V5903-3	342	V6000-029XL	66	V6000-01725-XD	77	V6090	135
V5202-14	123	V5550L-24	162	V5903N	342, 349	V6000-030	66	V6000-02036	76	V6091	135
V5202-4.5	123	V5550S	147	V5904	346	V6000-030XL	66	V6000-02036-D	77	V6092	135
V5202-5.5	123	V5550S-10	162	V5904-1	346	V6000-031	67	V6000-02036-X	76	V6093	135
V5420	338	V5550S-11	162	V5904-3	346, 359	V6000-031XL	67	V6000-02036-XD	77	V6094	135
V5421	339	V5550S-12	162	V5904-4	346, 359	V6000-032	69	V6000-02215	76	V6095	135
V5422	339	V5550S-13	162	V5905	344-345, 360	V6000-032XL	69	V6000-02215-X	76	V6096	135
V5423	339	V5550S-14	162	V5906	343, 345	V6000-033	69	V6000-02404	76	V6097	135
V5424	339	V5550S-15	162	V5906-1	343	V6000-033XL	70	V6000-02404-X	76	V6098	135
V5425	338	V5550S-16	162	V5909	288	V6000-035	70	V6000-02588	76	V6099	135
V5434	36	V5550S-17	162	V5916	364	V6000-035XL	70	V6000-02588-D	77	V6100	136
V5436	121	V5550S-18	162	V5916-XL	355, 365, 414-415	V6000-036	74	V6000-02588-X	76	V6101	136
V5437	151	V5550S-19	162	V5916-1	364	V6000-036XL	74	V6000-02588-XD	77	V6102	136
V5480	240	V5550S-21	162	V5916-2	364	V6000-037	74	V6008	131	V6103	136
V5485N	188	V5550S-22	162	V5922	262	V6000-040/4	80	V6012	150	V6104	136
V5488	242	V5550S-24	162	V5930	294	V6000-041/4	80	V6012-REP	150	V6105	136
V5489	44	V5554	352	V5931	294	V6000-042	75	V6014	120	V6106	136
V5489-1	57	V5554-2	353	V6000-01	67	V6000-042XL	75	V6014-REP	120	V6107	136
V5489-2	58	V5591	220	V6000-01XL	68	V6000-043	79	V6015	113	V6108	136
V5489-3	57	V5601	189	V6000-02	71	V6000-044	75	V6015-L	113	V6109	136
V5489-4	57	V5602	90	V6000-02XL	71	V6000-044XL	75	V6017	130	V6110	136
V5489-5	59	V5602-L	90	V6000-03	72	V6000-046	73	V6018	130	V6111	136
V5493	197	V5603	96	V6000-03XL	72	V6000-046XL	73	V6019	130	V6112	136
V5494	197	V5633N	96	V6000-3	65	V6000-047LR	82	V6028	296	V6113	136
V5496	198	V5633N-L	96	V6000-3-X	65	V6000-047M	82	V6028-1	296	V6114	136
V5496-1	198	V5634N	108	V6000-3P1	63	V6000-048	78	V6028-2	296	V6115	136
V5497	198	V5634N-L	108	V6000-3P1XL	63	V6000-050	80	V6028-3	296	V6116	136
V5502	193	V5636N	109	V6000-3P1XL-X	63	V6000-051	81	V6028-4	296	V6117	136
V5505	168	V5636N-L	109			V6000-052	81	V6029	297	V6118	136
V5505-1/2	168					V6000-053	81	V6029-1	297	V6119	136

VIGOR-No.	Seite	VIGOR-No.	Seite	VIGOR-No.	Seite	VIGOR-No.	Seite	VIGOR-No.	Seite	VIGOR-No.	Seite
V6120	136	V6202-10	133	V6500-140	207	V6688-XL	55	V6811-L	107	V7018-M12	164
V6121	136	V6202-11	133	V6500-160	207	V6721	91	V6811-76	248	V7018-M14	164
V6122	136	V6202-12	133	V6501-180	207	V6721-L	91	V6811-115	248	V7018-M16	164
V6123	136	V6202-13	133	V6502-200	207	V6722	92	V6811-125	248	V7018-M18	164
V6124	136	V6202-14	133	V6503-200	207	V6722-L	92	V6812	108	V7019	149
V6125	136	V6202-15	133	V6504-250	208	V6723	91	V6812-L	108	V7019-H10	164
V6126	136	V6202-16	133	V6510-10/4	199	V6723-L	91	V6813	106	V7019-H12	164
V6127	136	V6202-17	133	V6510-19/4	199	V6724	103	V6813-L	106	V7019-H14	164
V6128	137	V6202-19	133	V6510A-10	199	V6724-L	103	V6814	106	V7019-H17	164
V6129	137	V6202-21	133	V6510A-19	199	V6726	102	V6814-L	106	V7019-H19	164
V6130	137	V6202-22	133	V6510A-40	200	V6726-L	102	V6815N	109	V7019-H5	164
V6131	137	V6210-4	216	V6510B-10	199-200	V6740	258	V6815N-L	109	V7019-H6	164
V6137	137	V6210-10	216	V6510B-19	199-200	V6741	258	V6816N	110	V7019-H8	164
V6138	137	V6220-10	217	V6510B-40	200	V6742	244	V6816N-L	110	V7026	379
V6139	137	V6220-16	217	V6510C-12	199, 201	V6752-8	180	V6817	107	V7026-1	380
V6140	137	V6220-20	217	V6510C-19	199, 201	V6752-9	180	V6817-L	107	V7026-2	381
V6141	137	V6220-29	217	V6510C-40	201	V6752-10	180	V6818	107	V7027	344
V6142	137	V6220/4	217	V6510D-12	199, 201	V6752-11	180	V6818-L	107	V7030	382
V6143	137	V6221	53	V6510D-19	199, 202	V6752-12	180	V6821	104	V7030-2	383
V6144	137	V6222	94	V6510D-40	202	V6752-13	180	V6821-L	104	V7037-IP8	124
V6145	137	V6222-L	94	V6554	233	V6752-14	180	V6822	104	V7037-IP10	124
V6146	137	V6230-5	216	V6591	328	V6752-15	180	V6822-L	104	V7037-IP15	124
V6147	137	V6230-7	216	V6592	328	V6752-16	180	V6824	336	V7037-IP20	124
V6148	137	V6309	293	V6605	244	V6752-17	180	V6899N	232	V7037-IP25	124
V6149	137	V6311	293	V6606	244	V6752-18	180	V6905	235	V7037-IP27	124
V6150	61	V6312/10	295	V6610-L	59	V6752-19	180	V6906	234	V7037-IP30	124
V6151	137	V6393	54	V6610-XD	59	V6752/5	181	V6906-10	234	V7037-IPR8	124
V6152	137	V6393-S	54	V6610-XL	59	V6752/12	180	V6907	237	V7037-IPR10	124
V6153	137	V6394	54	V6611-6X8	183	V6799	205	V6907-1	237	V7037-IPR15	124
V6154	137	V6395	53	V6611-10X12	183	V6800-50	226	V6917	289	V7037-IPR20	124
V6155	137	V6396	53	V6611-14X18	183	V6800-75	226	V6917-REP	289	V7037-IPR25	124
V6156	138	V6397	54	V6611-20X24	183	V6801-65	227	V6952	220	V7037-IPR27	124
V6157	138	V6398	52	V6611/4	183	V6802	226	V6956	317	V7037-IPR30	124
V6158	138	V6435	245	V6612	150	V6803-75	226	V6973	246	V7050	335
V6159	138	V6435-XL	245	V6614	120	V6803-100	226	V6973-1	246	V7055-H5	159
V6160	138	V6436-L	245	V6614-REP	120	V6804	227	V7001	303	V7055-H6	159
V6161	138	V6436-XL	245	V6632	279, 282	V6805	227	V7001/4	303	V7055-H7	159
V6194	137	V6436-XXL	245	V6633	279, 282	V6806	227	V7010-125K80	248	V7055-H8	159
V6200	217	V6452	316	V6634	279, 282	V6807	105	V7015N	113	V7055-H10	159
V6200-2	217	V6452-H6	316	V6635	279, 282	V6807-L	105	V7015N-L	113	V7055-H12	159
V6200-3	217	V6452-H7	316	V6636	282	V6807-4	225	V7017	148	V7055-H14	159
V6200-4	217	V6452-H8	316	V6638	131	V6808	106	V7017-T30	164	V7055-IP40	156
V6200-5	217	V6452-1	316	V6643	102	V6808-L	106	V7017-T40	164	V7055-IP45	156
V6200-6	217	V6452-5	316	V6643-L	102	V6809	105	V7017-T45	164	V7055-IP50	156
V6200-7	217	V6452-6	316	V6650	112	V6809-L	105	V7017-T50	164	V7055-IP55	156
V6200-8	217	V6452-16	316	V6650-L	112	V6809-4	225	V7017-T55	164	V7055-IP60	156
V6202	128	V6452-17	316	V6685-1/20	56	V6810	105	V7017-T60	164	V7055-IPR40	156
V6202-1	132	V6452-18	316	V6685-2/20	56	V6810-L	105	V7017-T70	164	V7055-IPR45	156
V6202-2	140	V6452-19	316	V6685-3/10	56	V6810-115K40	248	V7017-T80	164	V7055-IPR50	156
V6202-3	138	V6452-21	316	V6685-4/10	56	V6810-115K60	248	V7018	149	V7055-IPR55	156
V6202-4	139	V6452-22	316	V6686/5	56	V6810-115K80	248	V7018-M5	164	V7055-IPR60	156
V6202-5	139	V6452-24	316	V6687/5	56	V6810-125K40	248	V7018-M6	164	V7055-T20	158
V6202-8	133	V6452-250	316	V6688	55	V6810-125K60	248	V7018-M8	164	V7055-T25	158
V6202-9	133	V6468	243	V6688-XD	55	V6811	107	V7018-M10	164	V7055-T27	158

Nummern- / Seiten-Verzeichnis



VIGOR-No.	Seite	VIGOR-No.	Seite	VIGOR-No.	Seite	VIGOR-No.	Seite	VIGOR-No.	Seite	VIGOR-No.	Seite
V7055-T30	158	V7133-5	361	V7200-T55	159	V7267	388	V7512-20	152	V7866	373
V7055-T40	158	V7133-6	361	V7200-T60	159	V7267-L	388	V7512-21	152	V7867	373
V7055-T45	158	V7133-7	361	V7200-T70	159	V7270	392	V7512-22	152	V7868	373
V7055-T50	158	V7133-8	361	V7201	390	V7270-L	392	V7512-23	152	V7869	373
V7055-T55H	157	V7133-9	361	V7201-L	390	V7273	393	V7512-24	152	V7870	373
V7055-T40H	157	V7133-10	361	V7202	141	V7273-L	393	V7512-27	152	V7917	145
V7055-T45H	157	V7133N	360-361	V7202-1	151	V7275	401	V7512-30	152	V7919	145
V7055-T50H	157	V7135	235	V7202-2	161	V7276	384	V7512-32	152	V7920	170
V7055-T55	158	V7135-150	235	V7202-3	160	V7276-2	385	V7512/17	142	V7920-EP4	133
V7055-T60H	157	V7140-H5	159	V7202-4	161	V7283	83	V7514-4	123	V7920-EP5	133
V7061	341	V7140-H6	159	V7202-5	161	V7283/2	83	V7514-5	123	V7920-EP6	133
V7071	341	V7140-H7	159	V7202-8	153	V7285	273	V7514-6	123	V7920-EP7	133
V7075-H17	159	V7140-H8	159	V7202-9	153	V7286	273	V7514-7	123	V7920-EP8	133
V7075-H19	159	V7140-H10	159	V7202-10	153	V7287	273	V7514-8	123	V7920-EP10	133
V7075-T60	158	V7140-H12	159	V7202-11	153	V7288	273	V7514-9	123	V7920-EP12	133
V7075-T70	158	V7140-H14	159	V7202-12	153	V7291	402	V7514-10	123	V7920-EP14	133
V7099	223	V7140-T40	158	V7202-13	153	V7323	90	V7514-11	123	V7920-EP16	133
V7099-S	223	V7140-T45	158	V7202-14	153	V7323-L	90	V7514-12	123	V7920-EP18	133
V7099/2	223	V7140-T50	158	V7202-15	153	V7385	271	V7514-13	123	V7920-EP20	133
V7100-H5	159	V7140-T55	158	V7202-16	153	V7401	283	V7514-14	123	V7920-EP22	133
V7100-H6	159	V7140-T60	158	V7202-17	153	V7402	250	V7514-4.5	123	V7920-EP24	133
V7100-H7	159	V7140-T70	158	V7202-18	153	V7403	250	V7514-5.5	123	V7980	395
V7100-H8	159	V7143-10	236	V7202-19	153	V7471	277	V7514/13	119		
V7100-H10	159	V7154	393	V7202-20	153	V7471-A	277	V7520	97		
V7100-H11	159	V7154-L	393	V7202-21	153	V7471-T	277	V7520-L	97		
V7100-H12	159	V7154-1	359	V7202-22	153	V7471-TL	277	V7525	318		
V7100-H13	159	V7154-2	359	V7202-24	153	V7471-TS	277	V7538-10	132		
V7100-T20	158	V7154-4	359	V7202-27	153	V7471-W	277	V7538-11	132		
V7100-T25	158	V7154N	346	V7202-30	153	V7471/17	277	V7538-12	132		
V7100-T27	158	V7158	282	V7202-32	153	V7471L-7	277	V7538-13	132		
V7100-T30	158	V7158-1	282	V7212	167	V7471L-8	277	V7538-14	132		
V7100-T40	158	V7158-2	282	V7212-H14	167	V7471L-9	277	V7538-15	132		
V7100-T45	158	V7158-3	282	V7212-H17	167	V7471L-10	277	V7538-16	132		
V7100-T50	158	V7158-4	282	V7212-H19	167	V7471L-11	277	V7538-17	132		
V7100-T55	158	V7158-5	282	V7212-H21	167	V7471L-12	277	V7538-18	132		
V7100-T60	158	V7158-6	282	V7212-M14	167	V7471S-7	277	V7538-19	132		
V7100-T70	158	V7158-7	282	V7212-M16	167	V7471S-8	277	V7538/10	130		
V7106	249	V7158-8	282	V7212-M18	167	V7471S-9	277	V7548	255		
V7107	249	V7181	302	V7221	243	V7471S-10	277	V7548-1	255		
V7120	291	V7181-1	302	V7244	290	V7471S-11	277	V7699	326		
V7124	186	V7181-2	302	V7251	400	V7471S-12	277	V7700	326		
V7124-PH1	186	V7181-3	302	V7251-1	400	V7500-3.9	252	V7722	388		
V7124-PH2	186	V7181-4	302	V7251-2	400-401	V7500/2	252	V7722-L	388		
V7124-PH3	186	V7181-5	302	V7251-3	400	V7512-8	152	V7723	388		
V7124-PZ1	186	V7181-6	302	V7251-4	400	V7512-10	152	V7723-L	388		
V7124-PZ2	186	V7200-H6	160	V7251-5	400	V7512-11	152	V7724	389		
V7124-T20	186	V7200-H7	160	V7252	398	V7512-12	152	V7724-L	389		
V7124-T25	186	V7200-H8	160	V7259	290	V7512-13	152	V7784	195		
V7124-T30	186	V7200-H10	160	V7261	392	V7512-14	152	V7857	354		
V7132N	281	V7200-H12	160	V7261-L	392	V7512-15	152	V7857-L	355		
V7133	360	V7200-H5	160	V7263	388	V7512-16	152	V7859	345		
V7133-2	361	V7200-T40	159	V7263-L	388	V7512-17	152	V7860	345		
V7133-3	361	V7200-T45	159	V7265	392	V7512-18	152	V7862	395		
V7133-4	361	V7200-T50	159	V7265-L	392	V7512-19	152	V7865	373		

V4999N, EAN 4047728**078726**
Zangen Satz

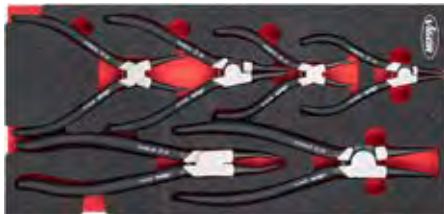

96

V5603, EAN 4047728**078917**
Schlagschrauber
Schraubendrehereinsatz Satz



96

V5633N, EAN 4047728**078740**
Zangen Satz



96

V5111N, EAN 4047728**078733**
Schraubendreher · Zangen Satz



108

V5634N, EAN 4047728**078757**
Hammer Zangen
Schraubendreher Satz



108



Neuheiten-Übersicht



V5636N, EAN 4047728078764
Zangen · Hammer Satz



109

V5637N, EAN 4047728078771
Zangen, Hammer · Meißel Satz



109

V6815N, EAN 4047728078795
Zangen Satz



109

V6816N, EAN 4047728078801
Zangen Satz



110

V5638N, EAN 4047728078788
Zangen · Hammer · Meißel Satz



112

T-Plus Schraubendreher-Einsatz

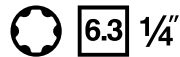

VIGOR No.	SW	EAN 4047728+
V7037-IP8	T8+	078276
V7037-IP10	T10+	078283
V7037-IP15	T15+	078290
V7037-IP20	T20+	078306
V7037-IP25	T25+	078313
V7037-IP27	T27+	078320
V7037-IP30	T30+	078337

124

T-Plus Schraubendreher-Einsatz



VIGOR No.	SW	EAN 4047728+
V7037-IPR8	T8+H	078399
V7037-IPR10	T10+H	078405
V7037-IPR15	T15+H	078412
V7037-IPR20	T20+H	078429
V7037-IPR25	T25+H	078436
V7037-IPR27	T27+H	078443
V7037-IPR30	T30+H	078450

124

T-Plus Steckschlüsseinsatz

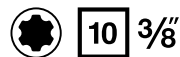

VIGOR No.	SW	EAN 4047728+
V7920-EP4	E4+	078146
V7920-EP5	E5+	078153
V7920-EP6	E6+	078160
V7920-EP7	E7+	078177
V7920-EP8	E8+	078184
V7920-EP10	E10+	078191
V7920-EP12	E12+	078207
V7920-EP14	E14+	078214
V7920-EP16	E16+	078221
V7920-EP18	E18+	078238
V7920-EP20	E20+	078245
V7920-EP22	E22+	078252
V7920-EP24	E24+	078269

133

V7917, EAN 4047728075831 T Kugelkopf Schraubendreher-Einsatz Satz

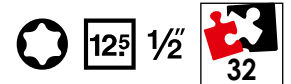

145

V7919, EAN 4047728075817 Innensechskant Kugelkopf Schraubendreher-Einsatz Satz

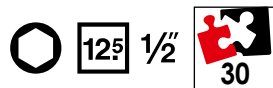

145

T-Plus Schraubendreher-Einsatz



VIGOR No.	SW	EAN 4047728+
V7055-IP40	T40+	078344
V7055-IP45	T45+	078351
V7055-IP50	T50+	078368
V7055-IP55	T55+	078375
V7055-IP60	T60+	078382

156

TR-Plus Schraubendreher-Einsatz

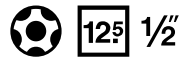

VIGOR No.	SW	EAN 4047728+
V7055-IPR40	T40+H	078467
V7055-IPR45	T45+H	078474
V7055-IPR50	T50+H	078481
V7055-IPR55	T55+H	078498
V7055-IPR60	T60+H	078504

156

T Schraubendreher-Einsatz



VIGOR No.	SW	EAN 4047728+
V7055-T40H	T40H	078511
V7055-T45H	T45H	078528
V7055-T50H	T50H	078535
V7055-T55H	T55H	078542
V7055-T60H	T60H	078559

157

V7920, EAN 4047728077781

T-Plus Steckschlüsseleinsatz Satz



170

V7784, EAN 4047728077842

Ratschen Schlüssel Bit Satz



195

V6510-10/4, EAN 4047728076951

Sicherungsring-Zangen Satz · 140 mm



V6510A-10
V6510B-10
V6510C-12
V6510D-12

199

V6510-19/4, EAN 4047728076968

Sicherungsring-Zangen Satz · 180 mm



V6510A-19
V6510B-19
V6510C-19
V6510D-19

199

V6500-140, EAN 4047728076753
Seitenschneider



207

V6500-160, EAN 4047728076746
Seitenschneider



207

V6501-180, EAN 4047728076760
Kombizange



207

V6502-200, EAN 4047728076777
Flachrund-Zange



207

V6503-200, EAN 4047728076791
Flachrund-Zange · abgewinkelt



207

V5639, EAN 4047728075589
Rohrzange



208

V6504-250, EAN 4047728077750
 Universalzange · mit Druckknopf



208

V5671N, EAN 4047728076715
 Schlagschrauber · Mini

125 1/2"



231

V6899N, EAN 4047728076944
 Schlagschrauber

20 3/4"



232

Handschuhe · Grip



245

VIGOR No.	Bezeichnung	EAN 4047728+
V6436-L	Handschuhe · Grip	077712
V6436-XL	Handschuhe · Grip	077729
V6436-XXL	Handschuhe · Grip	077736

V7500/2, EAN 4047728076210
 Video-Endoskop



252

V7500-3.9, EAN 4047728076227
 Sonde Ø 3,9 mm · semiflexibel



252

V6740, EAN 4047728077774
Abzieher Satz für Zündspulen · VAG



258

V4941N, EAN 4047728077293
Injektorschacht Reinigungs Satz



267

V7385, EAN 4047728077194
Getriebe Werkzeug Satz ·
MERCEDES-BENZ · 9G-Tronic



271

V7132N, EAN 4047728076500
Bremskolben-Rückstellwerkzeug
Satz · hydraulisch



281

V7120, EAN 4047728077200
Bremsleitung-Haltewerkzeug



291

V6311, EAN 4047728077798
Schlagschrauber
Steckschlüsseinsatz · TESLA



293

Neuheiten-Übersicht



V6312/10, EAN 4047728077804

Schlagschrauber Steckschlüsseleinsatz Satz

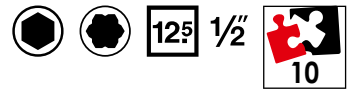

295

V4891-10.0, EAN 4047728077958

Induktionsheizgerät



312

V4126N, EAN 4047728078566

Klemmschrauben Demontage-
Werkzeug Satz



315

V4636N, EAN 4047728078719

Lager-Innenring Abzieher



319

V2867N, EAN 4047728077859
Sicherungsring-Werkzeug



330

V7071, EAN 4047728078610
Schrauben Satz · VAG



341

V7859, EAN 4047728078597
Radlager Demontage
Satz · Steckachsen



345

V7857, EAN 4047728078924
Traggelenk-Hülsen



354

V3055-275, EAN 4047728076494
Stützbein Satz · 275 mm



367

V7865, EAN 4047728078658
Silentlager Buchsen Satz · VAG



373

Neuheiten-Übersicht



V7722, EAN 4047728077262
 Presstativ Erweiterung



388

V7723, EAN 4047728077279
 Spindel Satz



388

V7724, EAN 4047728077286
 Kugelgelenk-Ausdrücker



389

V4906N, EAN 4047728077255
 Radlager Satz · Standard ·
 Demontage und Montage



390

V7862, EAN 4047728078627
 Achswellen Demontage Satz



395

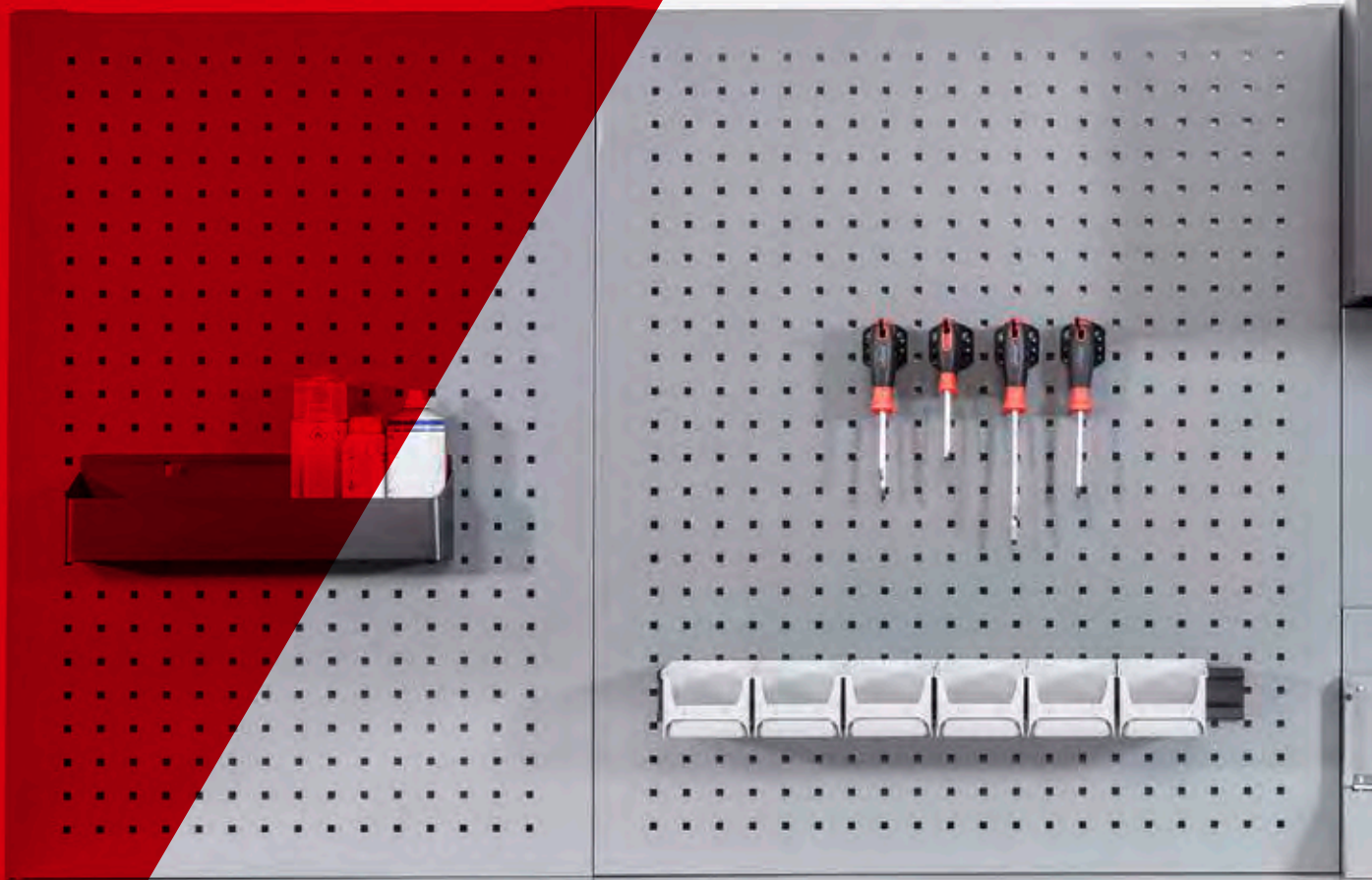

Werkstattwagen und Betriebseinrichtung

Werkstattwagen mit Sortiment 29–41

Mobile Werkbank mit Sortiment 42–43

Werkstattwagen ohne Sortiment 44–49

Mobile Werkbank ohne Sortiment 50–51

Servicewagen 52









Zubehör für Werkstattwagen 53–61

Schrankwand-System 63–73

Zubehör Schrankwand-System 74–83





VIGOR Nr.	h x b x t mm	Gesamttragkraft kg	Arbeitsplatte	Einlagengröße	Einlagenmaß mm	Anzahl Schubladen	Traglast pro Schublade kg	Schubladen-auszug	Schubladen Verschluss	
V5489		1000 x 677 x 459	400	Abnehmbare Schaumstoffmatte	3/3+	563 x 393	7	20	100%	Zentralverriegelung
V1902		375 x 723 x 459	/	/	3/3+	563 x 393	3	25	100%	Zentralverriegelung
V1901		1000 x 723 x 459	500	Lösemittelbeständiger Kunststoff	3/3+	563 x 393	7	25	100%	Zentralverriegelung
V1970		1375 x 723 x 459	500	Lösemittelbeständiger Kunststoff	3/3+	563 x 393	10	25	100%	Zentralverriegelung
V4481		1000 x 907 x 481	500	Lösemittelbeständiger Kunststoff	4/3+	750 x 393	8	25	100%	Zentralverriegelung
V4481-x		1017 x 940 x 514	500	Edelstahl-Arbeitsplatte	4/3+	750 x 393	8	25	100%	Zentralverriegelung
V4813		1000 x 1091 x 481	1000	Holz-Arbeitsplatte mit Auffangrinne	3/3+	563 x 393	8	40	100%	Zentralverriegelung
V4814		1000 x 907 x 481	1000	Holz-Arbeitsplatte mit Auffangrinne	4/3+	750 x 393	4	40	100%	Zentralverriegelung

Werkstattwagen mit Sortiment



V2379N, EAN 4047728055444



Werkstattwagen mit Sortiment und Auflagematte



Schubladen
Bestückungsvarianten:

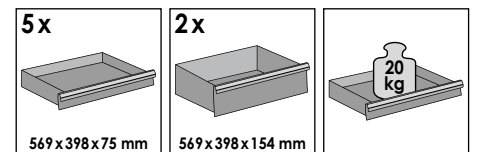
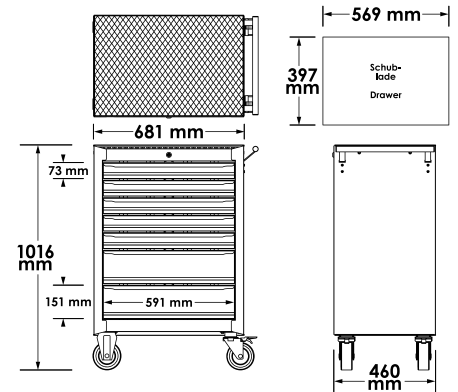

+ Sortiment

V5115N



V6726



V5111N



V2712N, EAN 4047728055451



Werkstattwagen mit Sortiment und Auflagematte



Schubladen
Bestückungsvarianten:

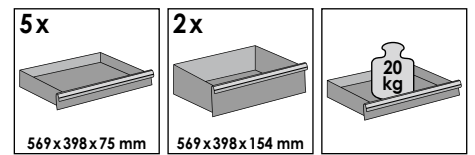
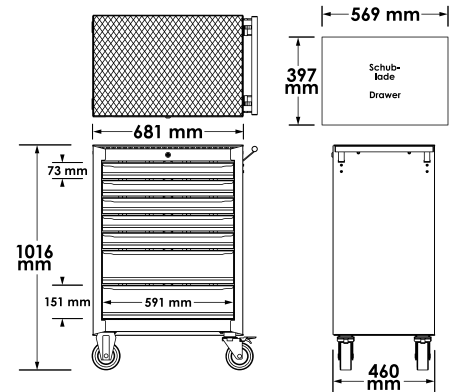

+ Sortiment

V2837

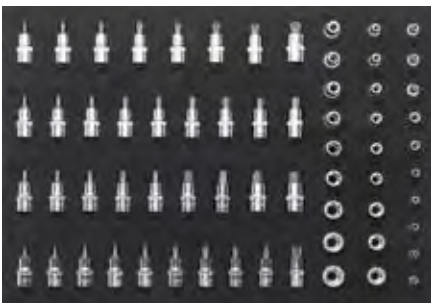

V6726



V5115N



V5111N



Werkstattwagen mit Sortiment



V4219, EAN 4047728042192



Werkstattwagen mit Sortiment und Kunststoff-Arbeitsplatte

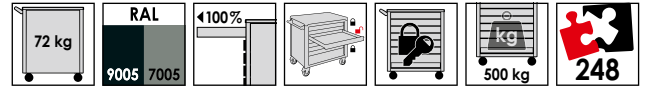

Schubladen
Bestückungsvarianten:

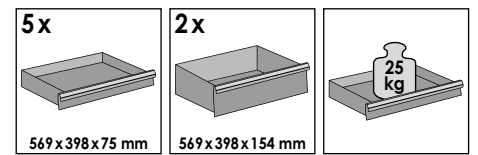
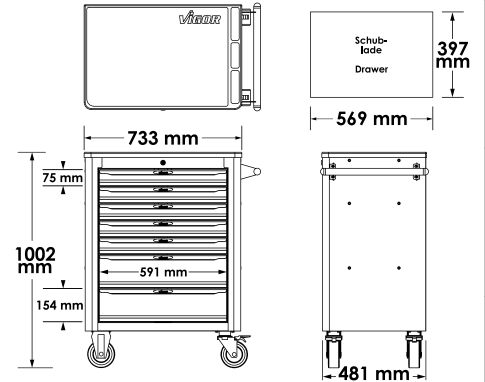

+ Sortiment

V6643



V4188



V5634N



V5055, EAN 4047728050562

VIGOR
SERIES **L**

Werkstattwagen mit Sortiment und Kunststoff-Arbeitsplatte

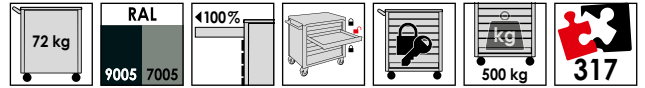

Schubladen
Bestückungsvarianten:

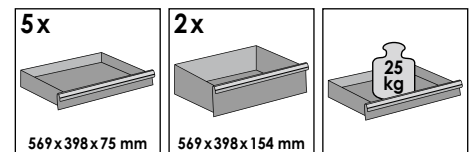
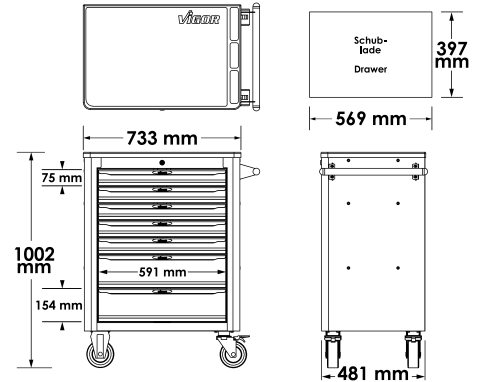

+ Sortiment

V4188



V4753

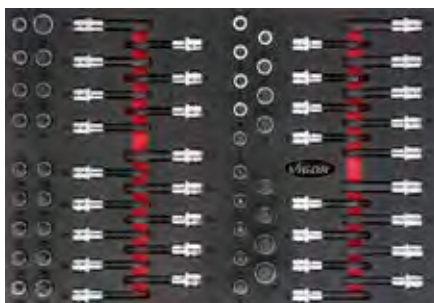

V6643



V5634N



Werkstattwagen mit Sortiment



V4560, EAN 4047728045605



Werkstattwagen mit Sortiment und Kunststoff-Arbeitsplatte

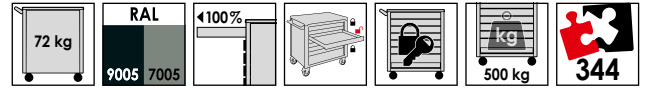

Schubladen
Bestückungsvarianten:

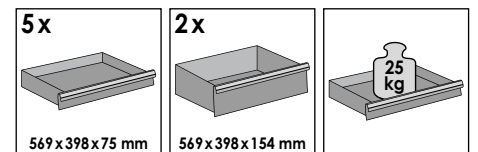
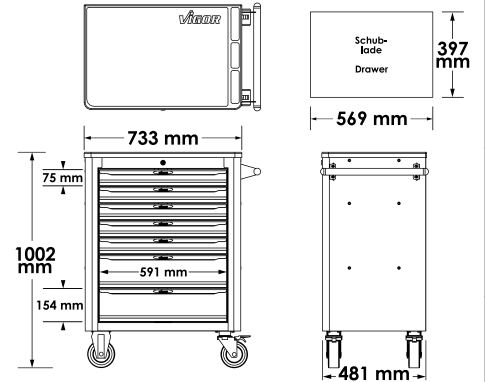

+ Sortiment

V4188



V2837

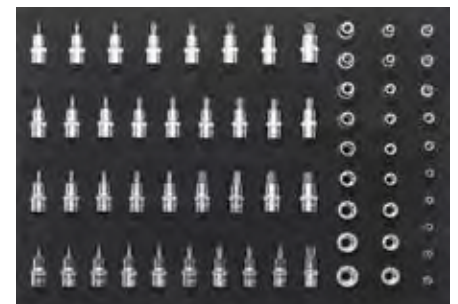

V4230



V5637N



V6643



V4561, EAN 4047728045810

VIGOR
SERIES **L**

Werkstattwagen mit Sortiment und Aufsatzkoffer

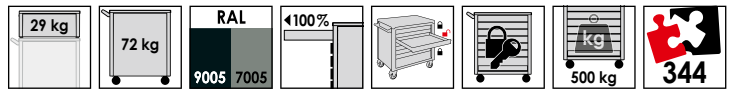

Schubladen
Bestückungsvarianten:

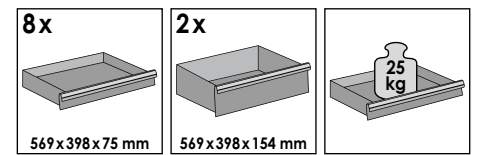
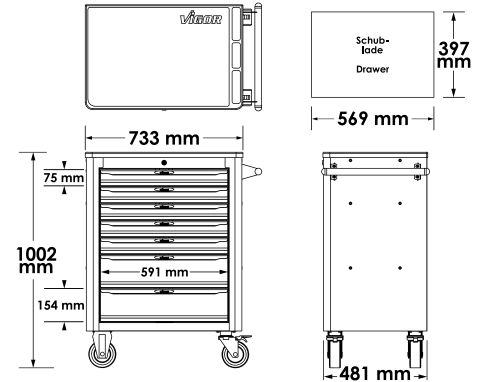

+ Sortiment

V4188



V2837



V4230



V6643



V5637N



Werkstattwagen mit Sortiment



V4542, EAN 4047728045421



Werkstattwagen mit Sortiment und Kunststoff-Arbeitsplatte

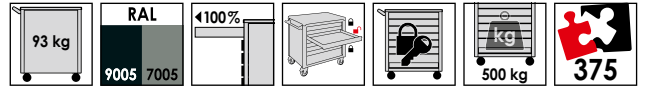

Schubladen Bestückungsvarianten:

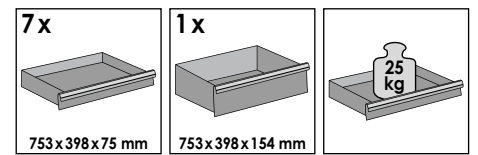
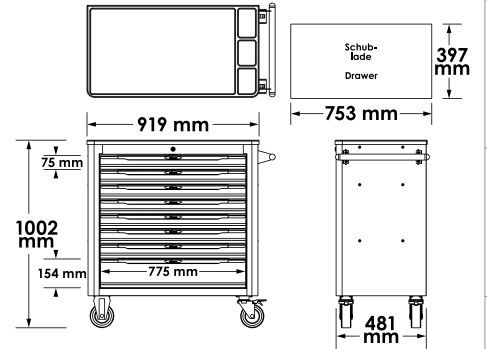

+ Sortiment

V4586



V6650



V5170



V5638N



V5434, EAN 4047728054348

VIGOR
SERIES **XL**

Werkstattwagen mit Sortiment und Kunststoff-Arbeitsplatte

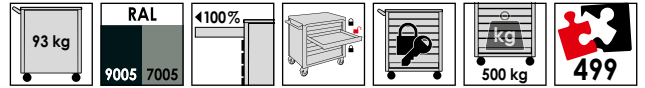

Schubladen Bestückungsvarianten:

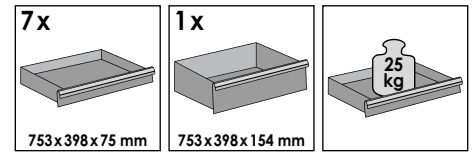
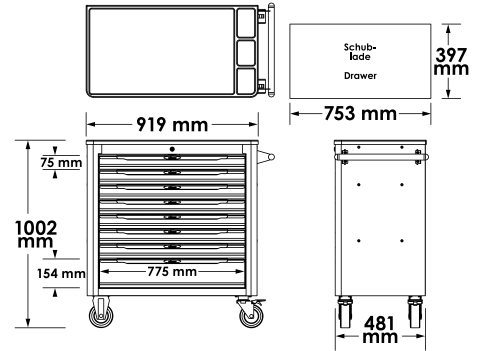

+ Sortiment

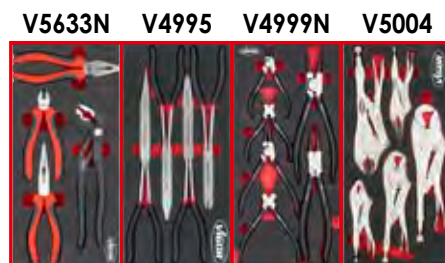
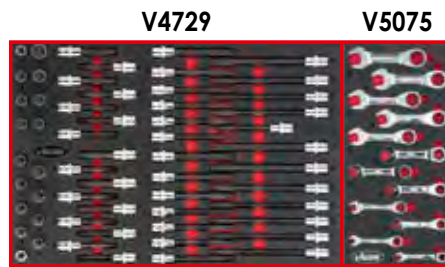
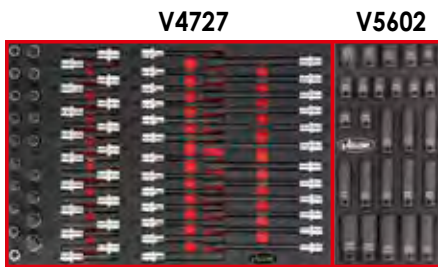
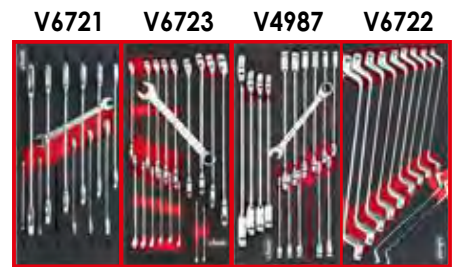
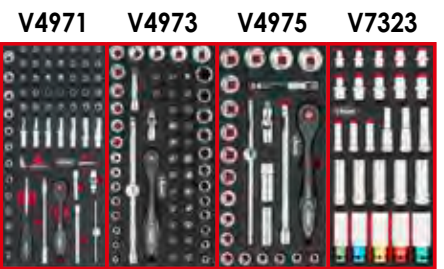

Werkstattwagen mit Sortiment



V4481-X/375, EAN 4047728062350



Werkstattwagen mit Sortiment und Edelstahl-Arbeitsplatte

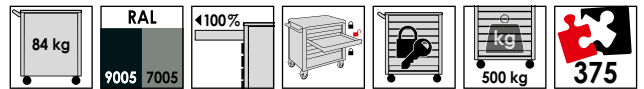

Schubladen Bestückungsvarianten:

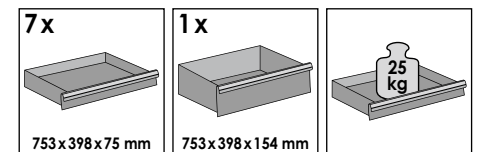
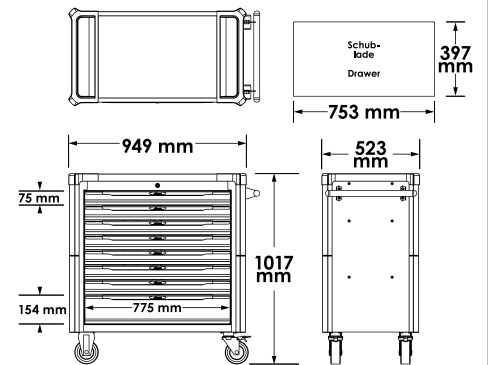

+ Sortiment

V4586



V6650



V5170



V5638N



V4481-X/466, EAN 4047728074674

VIGOR
SERIES **XL**

Werkstattwagen mit Sortiment und Edelstahl-Arbeitsplatte

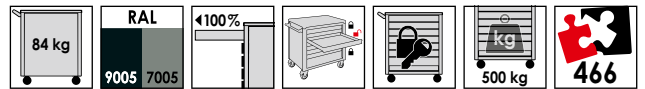

Schubladen Bestückungsvarianten:

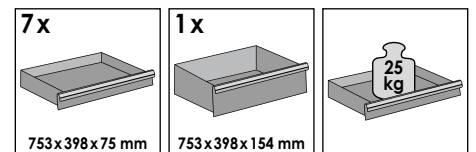
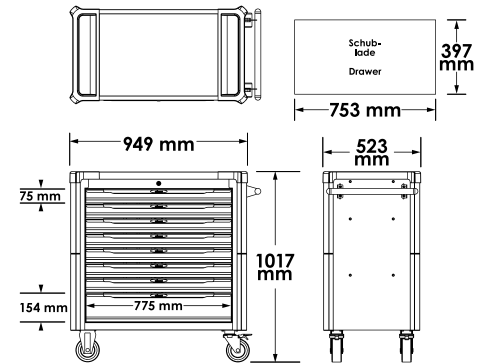

V2393-S



V6394



+ Sortiment

V4586



V5170



V6015



V6650



V7015N



Werkstattwagen mit Sortiment



V4481-X/499, EAN 4047728062367



Werkstattwagen mit Sortiment und Edelstahl-Arbeitsplatte

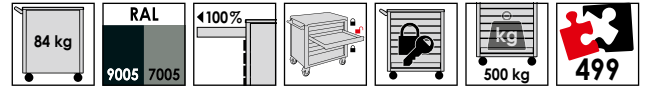

Schubladen Bestückungsvarianten:

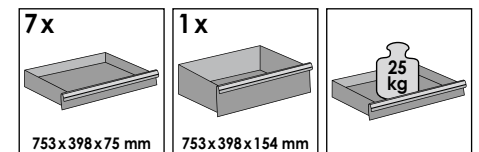
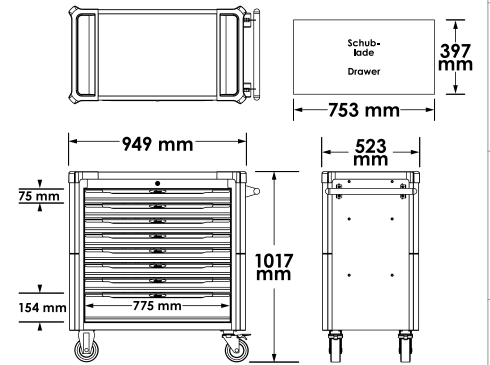

V4971 V4973 V4975 V7323



+ Sortiment

V4727

V5602



V4729

V5075



V6721

V6723

V4987

V6722



V5170

V5633N

V4995

V4999N

V5004

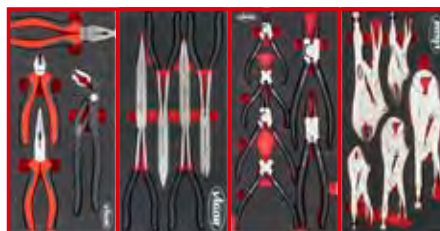
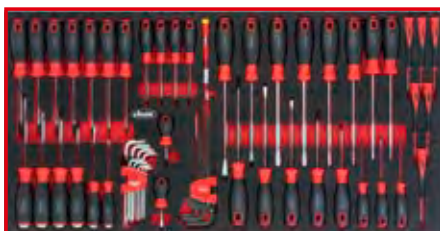

V5006

V5017

V5070

V5072



V4481-XD/469, EAN 4047728068512

VIGOR
SERIES **XD**

Extratiefer Werkstattwagen mit Sortiment und Edelstahl-Arbeitsplatte

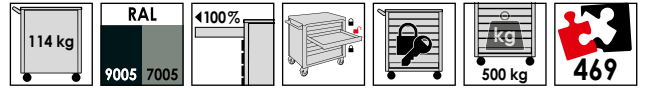

Schubladen
Bestückungsvarianten:

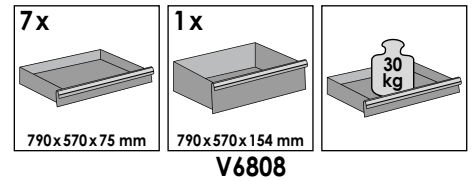
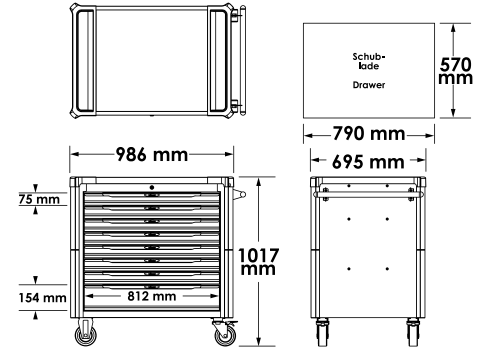

V6808

+ Sortiment

V4481-EXTRA DEEP

V6821

V6822N



V6807

V6808

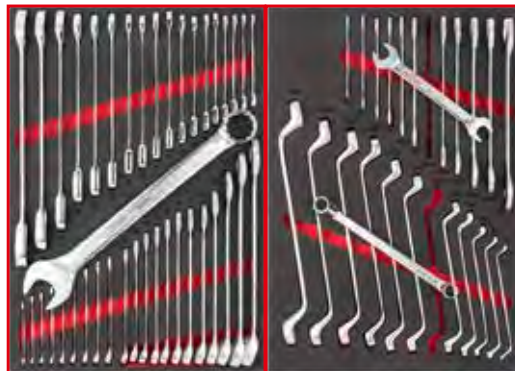

V6813

V6814



V6815N

V6816

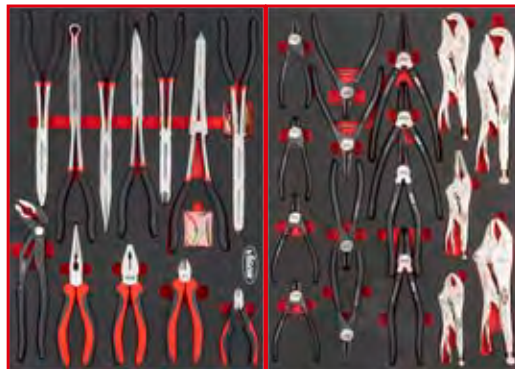

Werkstattwagen mit Sortiment



V4481-XD/775, EAN 4047728068529



Extratiefer Werkstattwagen mit Sortiment und Edelstahl-Arbeitsplatte



V4481 - EXTRA DEEP

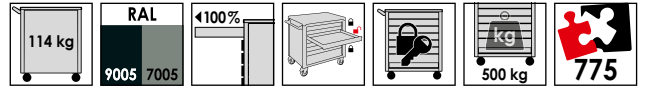

Schubladen
Bestückungsvarianten:

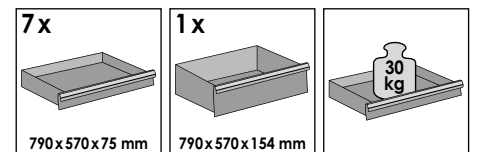
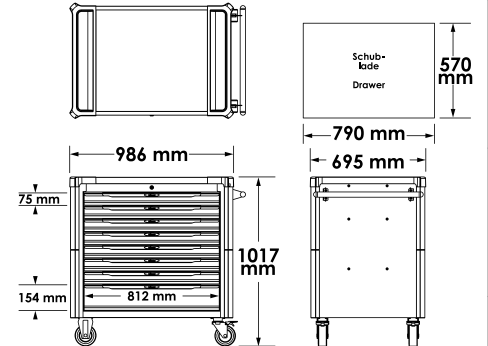

V6821

V6822



+ Sortiment

V6809

V6810

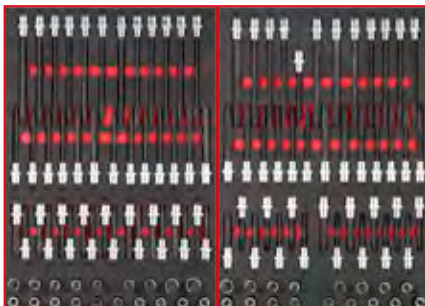

V6807

V6808

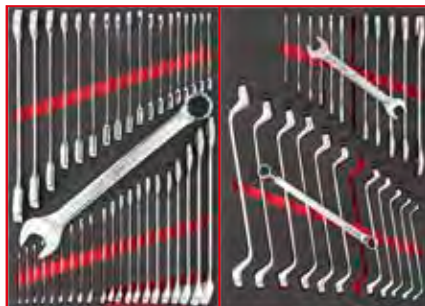

V6813

V6814



V6815

V6816N

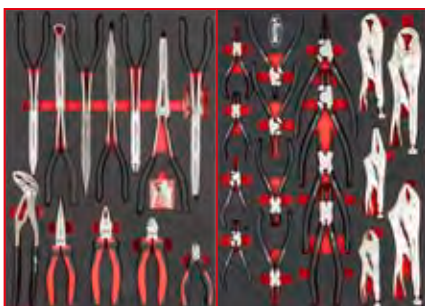

V6817

V6818

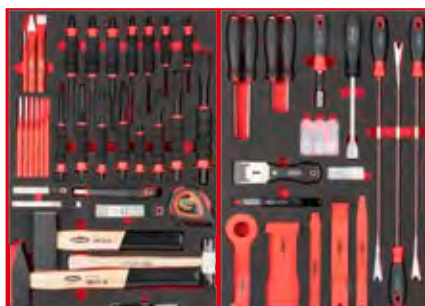

V6811

V6812

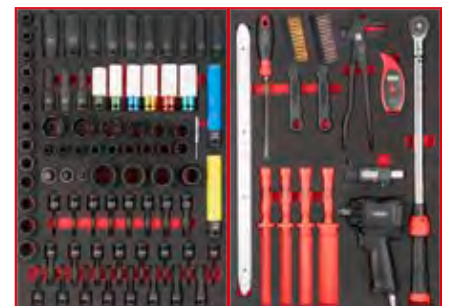

V5156, EAN 4047728051569

VIGOR
SERIES **L**

Mobile Werkbank mit Sortiment

• Lieferung ohne Fahrgriff

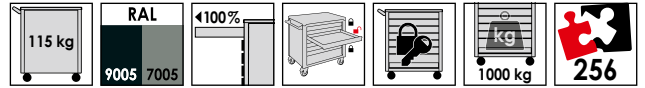

Schubladen
Bestückungsvarianten:

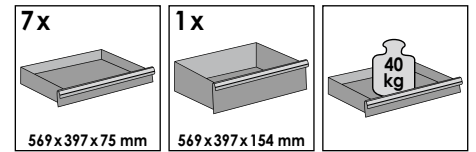
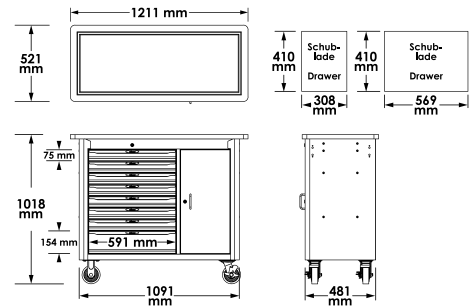

+ Sortiment

V6643



V4230



V4188



V5636N



Mobile Werkbank mit Sortiment



V5158, EAN 4047728051583



Mobile Werkbank mit Sortiment

• Lieferung ohne Fahrgriff

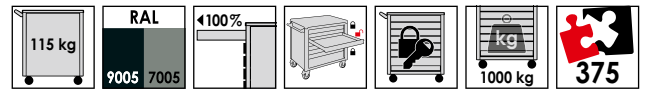

Schubladen
Bestückungsvarianten:

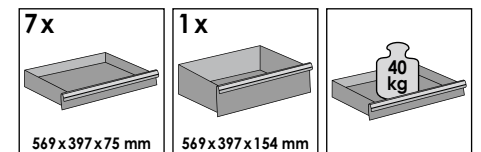
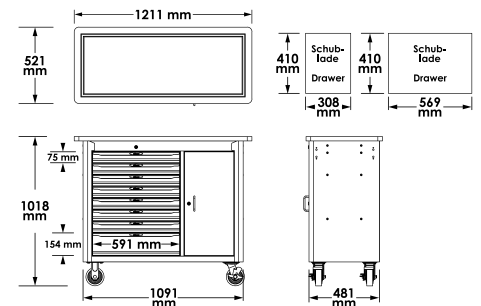

+ Sortiment

V4188



V4727

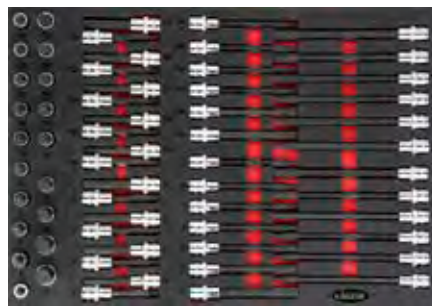

V4729



V6643



V4230



V5636N



V5489, EAN 4047728054898

VIGOR
SERIES **M**

Werkstattwagen ohne Sortiment

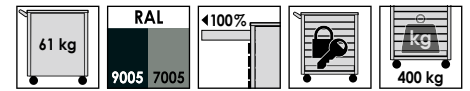

Schubladen
Bestückungsvarianten:

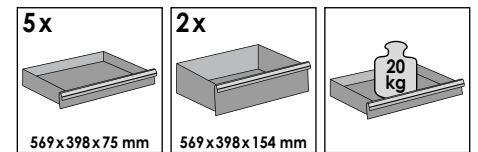
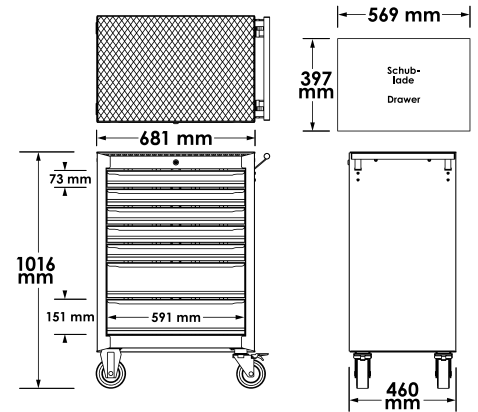

Werkstattwagen ohne Sortiment



V1901, EAN 4047728019019



Werkstattwagen ohne Sortiment

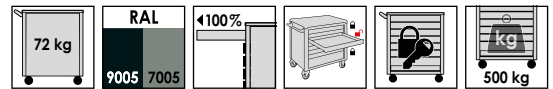

Schubladen
Bestückungsvarianten:

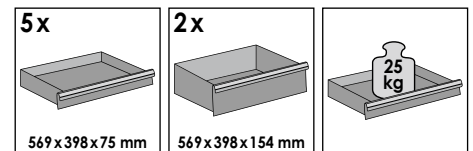
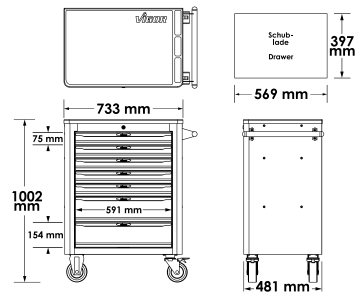

V1902, EAN 4047728019026



Aufsatzkoffer für Werkstattwagen V1901

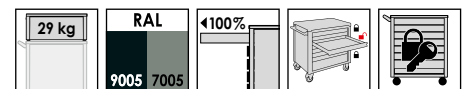

Schubladen
Bestückungsvarianten:

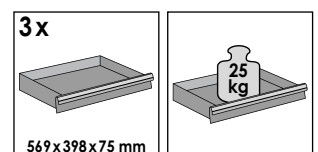
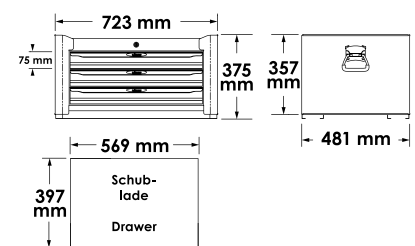

– Lieferung ohne Kunststoffhaube,
siehe V1909 –



V1970, EAN 4047728019705

VIGOR
SERIES **L**

Werkstattwagen inklusive Aufsatzkoffer, ohne Sortiment

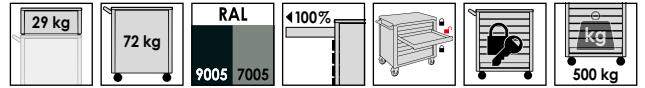

Schubladen
Bestückungsvarianten:

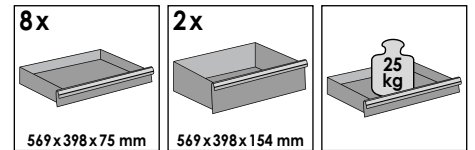
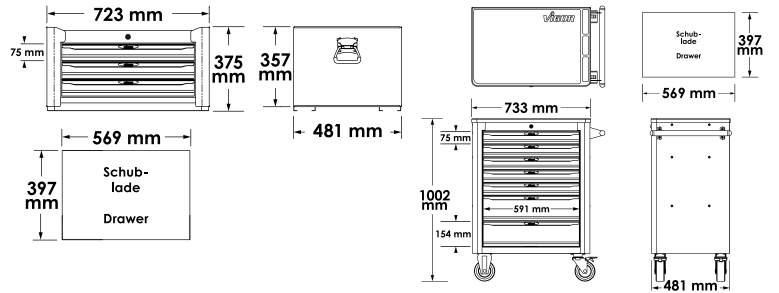

Werkstattwagen ohne Sortiment



V4481, EAN 4047728044813



Werkstattwagen ohne Sortiment, mit Kunststoff-Arbeitsplatte

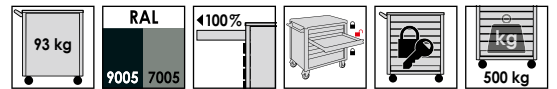

Schubladen Bestückungsvarianten:

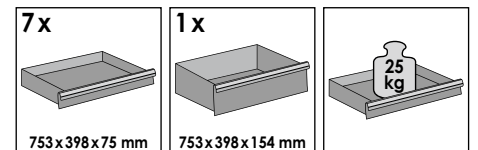
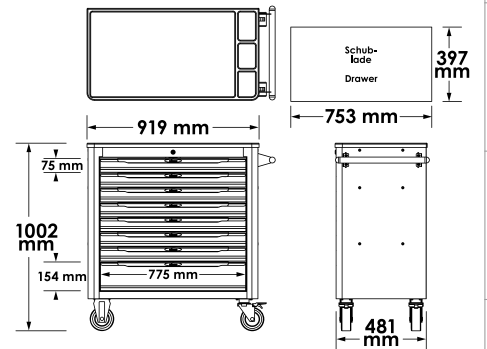

V4481-X, EAN 4047728060721

VIGOR
SERIES **XL**

Werkstattwagen ohne Sortiment, mit Edelstahl-Arbeitsplatte

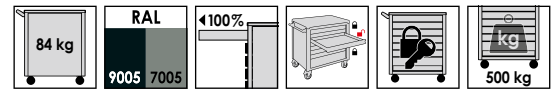

Schubladen Bestückungsvarianten:

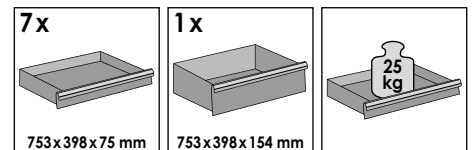
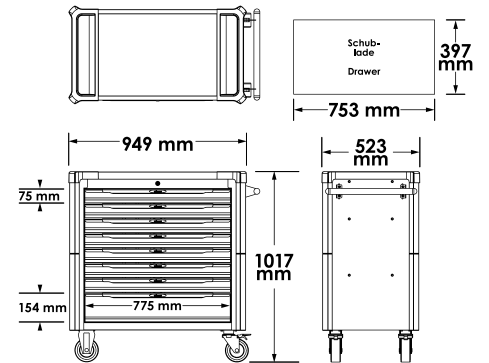

Werkstattwagen ohne Sortiment



V4481-XD, EAN 4047728066488



Extratiefer Werkstattwagen ohne Sortiment mit Edelstahl-Arbeitsplatte



V4481 - EXTRA DEEP

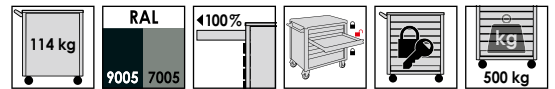

Schubladen
Bestückungsvarianten:

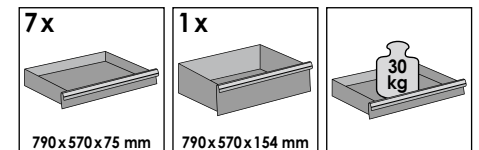
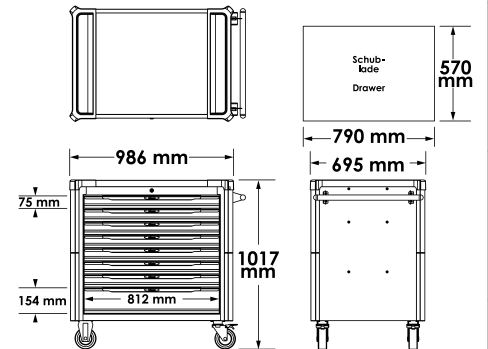

V4813, EAN 4047728048132

VIGOR
SERIES **L**

Mobile Werkbank ohne Sortiment

• Lieferung ohne Fahrgriff

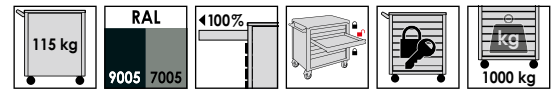

Schubladen Bestückungsvarianten:

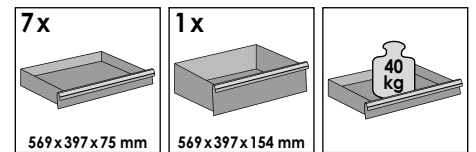
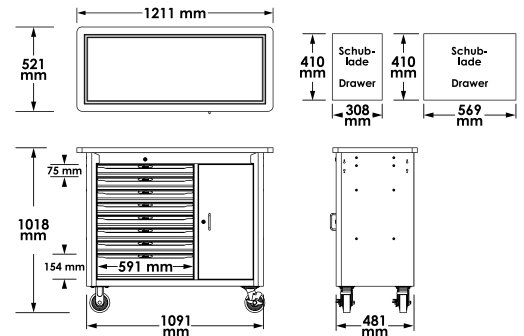

Mobile Werkbank ohne Sortiment



V4814, EAN 4047728048149



Mobile Werkbank ohne Sortiment

• Lieferung ohne Fahrgriff

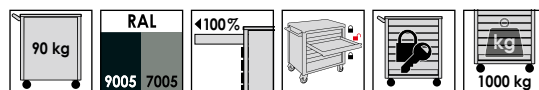

Schubladen Bestückungsvarianten:

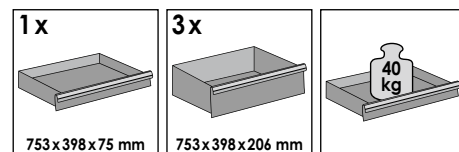
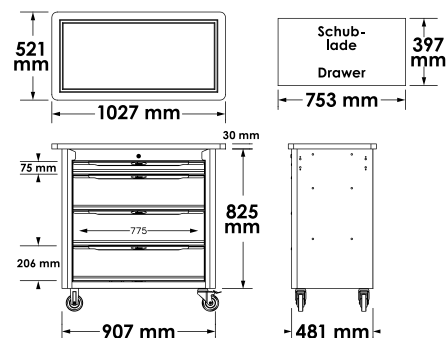

V4758, EAN 4047728**047586**

Servicewagen

- Stabile Stahlblech-Konstruktion (1 mm starke Zwischenbleche und 1,5 mm starke Winkelemente)
- Mittlere Ebene in 7 Stufen um 30 mm höhenverstellbar, für z.B. Kanister
- Tragkraft pro Boden: 40 kg
- Große kugelgelagerte Räder (Ø 100 mm), 2 Lenkrollen, 2 Bockrollen
- Einfaches Bewegen auch bei hoher dynamischer Last
- Stabiler, fest am Korpus montierter Fahrgriff
- Gewicht: 19 kg

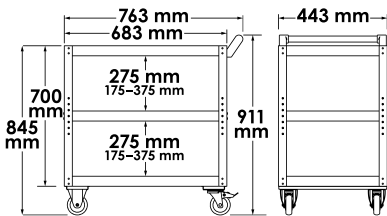

VIGOR No.	Bezeichnung		EAN 4047728+
V5180	Lenkrolle (Paar) · für Servicewagen V4758	2	051804
V5191	Bockrolle (Paar) · für Servicewagen V4758	2	051910



V6398, EAN 4047728**071314**

Laptop-Halter · dreh- und schwenkbar

- Passend für alle Serien Bj. 07/2019 → (mit vier Gewindehülsen)
- Schwenk-, und arretierbar
- 360° drehbar
- Frontale und seitliche Abkantung schützt das Gerät vor Sturz
- Ablagefläche lässt sich auf die gewünschte Neigung einstellen
- Vier Zusatzlochungen zum Durchführen von Kabeln

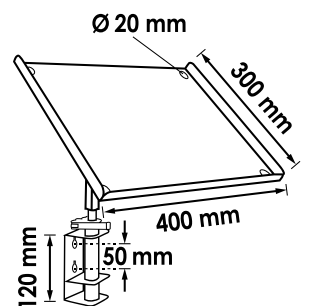

V6221, EAN 4047728062213

Laptop-Tisch

- Zusätzliche Ablagefläche für Laptop, Tablets, Werkzeuge oder Kfz-Bauteile
- Passend für alle Serien
- Auf- und zuklappbar im montierten Zustand
- Erweiterung der Werkstattwagen-Oberfläche für mehr Ordnung und Übersicht beim Arbeiten
- Arretierung verhindert unbeabsichtigtes Einklappen des Tisches
- Maximal zugelassene Belastbarkeit: 25 kg



Verschraubte Arretierung

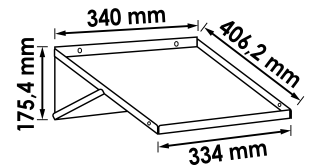

V6395, EAN 4047728070522

Abfall-Behälter

- Entsorgung von Abfall oder Stofflappen
- Passend für alle Serien
- Auch zur Lagerung von Werkzeug geeignet
- Fassungsvermögen: 20 l

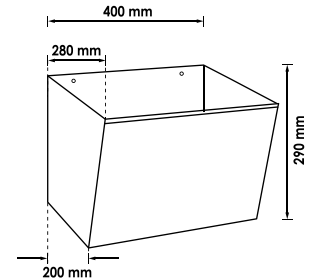

V6396, EAN 4047728069601

Schraubendreher-Halter

- Schneller Zugriff auf Schraubendreher direkt am Werkstattwagen
- Passend für alle Serien
- Für 12 Schraubendreher

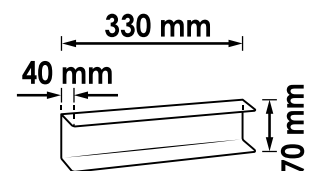

V6394, EAN 4047728069595

Schlagschrauber-Halter

- Ablegen eines Schlagschraubers direkt am Werkstattwagen
- Passend für alle Serien Bj. 07/2019→ (mit vier Gewindehülsen)
- Kunststoff-Kantenschutz schützt vor Kratzern beim Einsetzen des Schlagschraubers
- Schlagschrauber geeignet

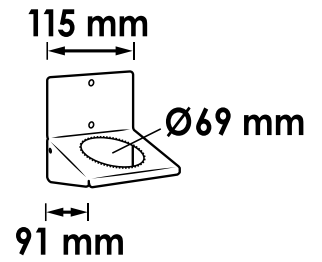

V2397, EAN 4047728023979

Papierrollen-Halter

- Aufhängen von Papierrollen direkt am Arbeitsplatz
- Passend für alle Serien
- Ohne Papierrolle
- Maximale Breite der Papierrolle: 370 mm

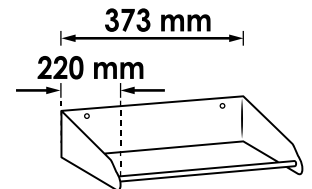

V6397, EAN 4047728069793

Papierrollen-Halter · schwenkbar

- Aufhängen von Papierrollen direkt am Arbeitsplatz
- Passend für alle Serien
- Ohne Papierrolle
- Maximale Breite der Papierrolle: 320 mm

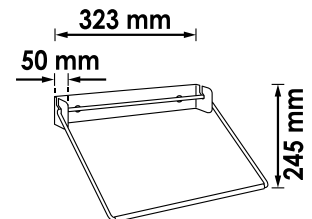

Dokumentenhalter

- Ablegen von Klemmbrettern oder Auftragsaschen direkt am Arbeitsplatz
- Passend für alle Serien
- Optimale Unterbringung von Dokumenten oder Werkstattunterlagen direkt am Arbeitsplatz

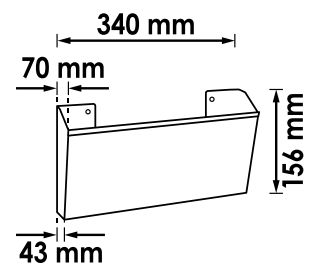

VIGOR No.	Bezeichnung	Länge x Breite x Höhe mm	EAN 4047728+
V6393-S	Dokumenten-Halter · klein · Bodentiefe 43 mm	340 x 70 x 156	069205
V6393	Dokumenten-Halter · groß · Bodentiefe 100 mm	340 x 146 x 176	069519

Dosenhalter

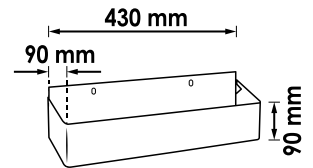

VIGOR No.	Bezeichnung	EAN 4047728+
V2393	Dosenhalter · für Series M · Series L · Series XL · Series XD (ausgenommen V4481-X) · bis zu 5 Dosen	023931
V2393-S	Dosenhalter · kurz · für alle Serien · bis zu 4 Dosen	062046
V2393-XD	Dosenhalter · extra lang · für Series XD · bis zu 6 Dosen	067614

Kleinteilefach

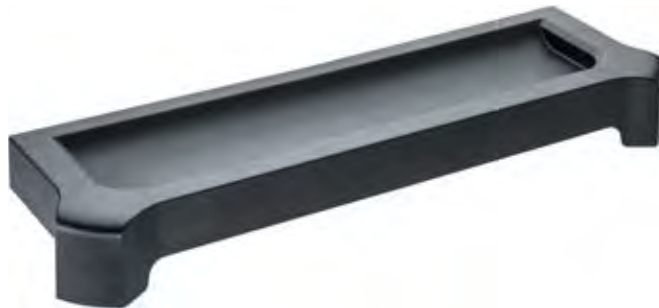
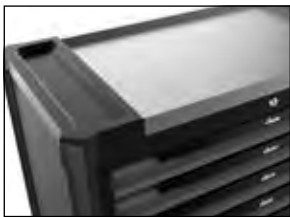

VIGOR No.	Bezeichnung	EAN 4047728+
V4481-X-4	Kleinteilefach · V4481-X	073639
V4481-XD-4	Kleinteilefach · V4481-XD	073646

Trennblech Satz

- Sortierung von Kleinteilen in Werkstattwagen oder Schrankwand-Unterschrank
- Alle vier Einteilblech-Größen kompatibel mit dem Trennblech Satz
- Einteilbleche ineinander einsetzbar dank asymmetrischer Stanzung
- Feuerverzinkte Oberfläche verhindert Rostbildung

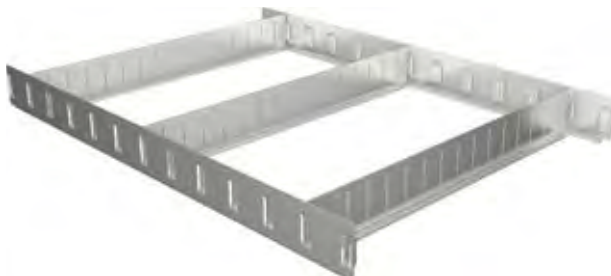

192 Einteilungen möglich

VIGOR No.	Bezeichnung	XX	EAN 4047728+
V6688	Trennblech Satz Series M und Series L	5	070249
V6688-XL	Trennblech Satz Series XL	6	070096
V6688-XD	Trennblech Satz Series XD	6	070089



Einteilblech Satz

- Kompatibel mit allen Trennblech Sätzen und Querträgern
- Zur Einteilung innerhalb einer Spalte

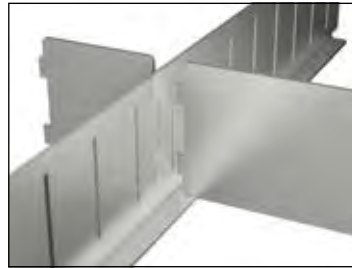
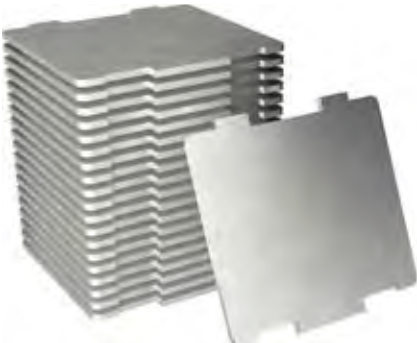

4 verschiedene Einteilblech-Längen – für alle Systeme verwendbar

VIGOR No.	Bezeichnung		EAN 4047728+
V6685-1/20	Einteilblech Satz · klein 45 mm	20	070133
V6685-2/20	Einteilblech Satz · mittel 91 mm	20	070126
V6685-3/10	Einteilblech Satz · groß 137 mm	10	070119
V6685-4/10	Einteilblech Satz · extragroß 183 mm	10	070102

Querträger Satz

- Feuerverzinkte Oberfläche verhindert Rostbildung



Dank Abkantung mehr Stabilität und Halt

VIGOR No.	Bezeichnung		EAN 4047728+
V6687/5	Querträger Satz für Series XD	5	070072
V6686/5	Querträger Satz für Series M · Series L und Series XL	5	070065

Bockrolle



VIGOR No.	Bezeichnung		EAN 4047728+
V1907	Bockrolle · für Werkstattwagen Series M · Series L · Series XL · Series XD	1	019071
V4814-3	Bockrolle (Paar) · für Werkstattwagen Series XL · Series XL Spezial und Werkbänke	2	053044
V5191	Bockrolle (Paar) · für Servicewagen V4758	2	051910

Lenkrolle mit Feststellbremse



VIGOR No.	Bezeichnung		EAN 4047728+
V1908	Lenkrolle · für Werkstattwagen Series M · Series L · Series XL · Series XD	1	019088
V4814-2	Lenkrolle (Paar) · für Werkstattwagen Series XL · Series XL Spezial und Werkbänke	2	053037
V5180	Lenkrolle (Paar) · für Servicewagen V4758	2	051804

Schublade · flach



VIGOR No.	Bezeichnung	Länge x Breite x Höhe mm	EAN 4047728+
V5489-4	Schublade · flach · 569 x 398 x 75 mm · für Series M	589 x 398 x 75	055413
V1905	Schublade · flach · 569 x 398 x 75 mm · für Series L · V1901 · V1902 · Werkbank V4813	589 x 398 x 75	019057
V4112	Schublade · flach · 753 x 398 x 75 mm · für Series XL · Series XL Spezial	753 x 398 x 75	041126
V4481-XD-2	Schublade · flach · für Series XD	790 x 570 x 75	067812

Schublade · hoch



VIGOR No.	Bezeichnung	Länge x Breite x Höhe mm	EAN 4047728+
V5489-3	Schublade · hoch · 569 x 398 x 154 mm · für Series M	589 x 398 x 154	055307
V1906	Schublade · hoch · 569 x 398 x 154 mm · für Series L · V1901 · Werkbank V4813	569 x 398 x 154	019064
V4111	Schublade · hoch · 753 x 398 x 154 mm · für Series XL	753 x 398 x 154	041119
V4814-1	Schublade · hoch · 741 x 397 x 206 mm · für Series XL Spezial	741 x 397 x 206	053020
V4481-XD-3	Schublade · hoch · für Series XD	790 x 570 x 154	067829

Verriegelungssystem



VIGOR No.	Bezeichnung	EAN 4047728+
V2462	Ersatzschloss für alle VIGOR Werkstattwagen und Werkbänke	024624
V1904	Verriegelungssystem für alle VIGOR Werkstattwagen und Werkbänke	019040

Führungsschienen (Paar)



VIGOR No.	Bezeichnung		EAN 4047728+
V1903	Führungsschienen (Paar) · für Series L · Series XL	2	019033
V5489-1	Führungsschienen (Paar) · für Series M	2	055284
V4481-XD-1	Führungsschienen (Paar) · für Series XD	-	067805



Arbeitsplatte



VIGOR No.	Bezeichnung	EAN 4047728+
V1909	Arbeitsplatte 723x459 mm · Kunststoff · für Werkstattwagen und Aufsatzkoffer Series L	019095
V4122	Arbeitsplatte 907x481 mm · Kunststoff · für Werkstattwagen Series XL	041225

Arbeitsplatte



VIGOR No.	Bezeichnung	EAN 4047728+
V4814-4	Arbeitsplatte 1030x520 mm · Holz · für mobile Werkbank Series XL	053051
V4813-1	Arbeitsplatte 1201x520 mm · Holz · für Werkstattwagen Series L	053013

V5489-2, EAN 4047728055291

Schaum-Auflagematte

- Für Werkstattwagen Series M
- LxB: 670x450 mm

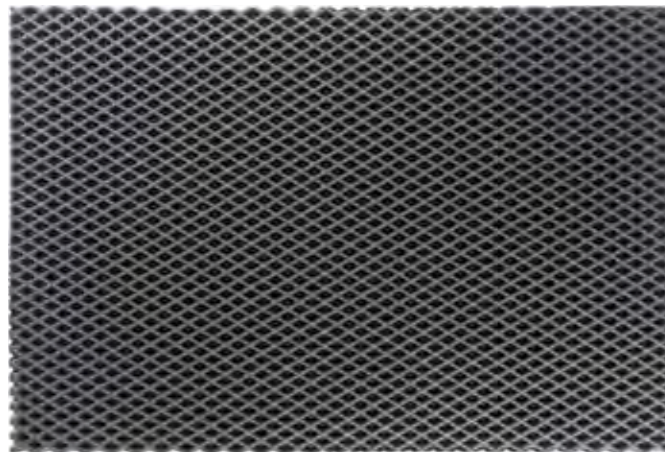

V4813-2, EAN 4047728059268

Einlegeboden

- Für Werkbank VIGOR V4813
- LxB: 400x450 mm



Universal Abdeckhaube

- Abdecken von Werkstattwagen, Möbeln oder Gartengeräten (Für den Innenbereich oder Außenbereich mit Überdachung geeignet)
- Vliesstoff (nicht feuchtigkeitsbeständig, nicht waschmaschinegeeignet, nur punktuell reinigen)



Schützt vor Staub und Dreck bei längerer Nichtnutzung

VIGOR No.	Bezeichnung	Länge x Breite x Höhe mm	EAN 4047728+
V6610-L	Universal Abdeckhaube · für Series L	530x820x880	075732
V6610-XL	Universal Abdeckhaube · für Series XL	720x1060x880	075749
V6610-XD	Universal Abdeckhaube · für Series XD	540x1060x880	075756

Fahrgriff

- Einfaches Rangieren von Werkstattwagen und Werkbänken
- Fahrgriff · für Werkstattwagen · Series M



VIGOR No.	EAN 4047728+
V5489-5	075626

Fahrgriff

- Einfaches Rangieren von Werkstattwagen und Werkbänken
- Fahrgriff · für Werkstattwagen · Series L und Series XL



VIGOR No.	EAN 4047728+
V4893	048934

Fahrgriff

- Einfaches Rangieren von Werkstattwagen
- Fahrgriff · für Werkstattwagen · Series XL · Edelstahl



VIGOR No.	EAN 4047728+
V4481-X-5	075619

Fahrgriff

- Einfaches Rangieren von Werkstattwagen
- Fahrgriff · für Werkstattwagen · Series XD



VIGOR No.	EAN 4047728+
V4481-XD-5	075602



Werkzeughaken Satz

- Aufhängung von Werkzeugen
- Verwendung mit Aufsatzschrank V2532 und Lochwandplatten V6000-05 · V6000-015



VIGOR No.	mm	EAN 4047728+
V2517	25	025171

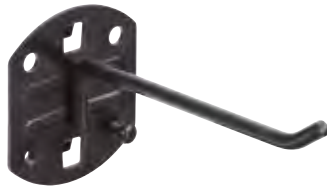

VIGOR No.	mm	EAN 4047728+
V2518	100	025188



VIGOR No.	mm	EAN 4047728+
V2519	25	025195



VIGOR No.	mm	EAN 4047728+
V2520	100	025201

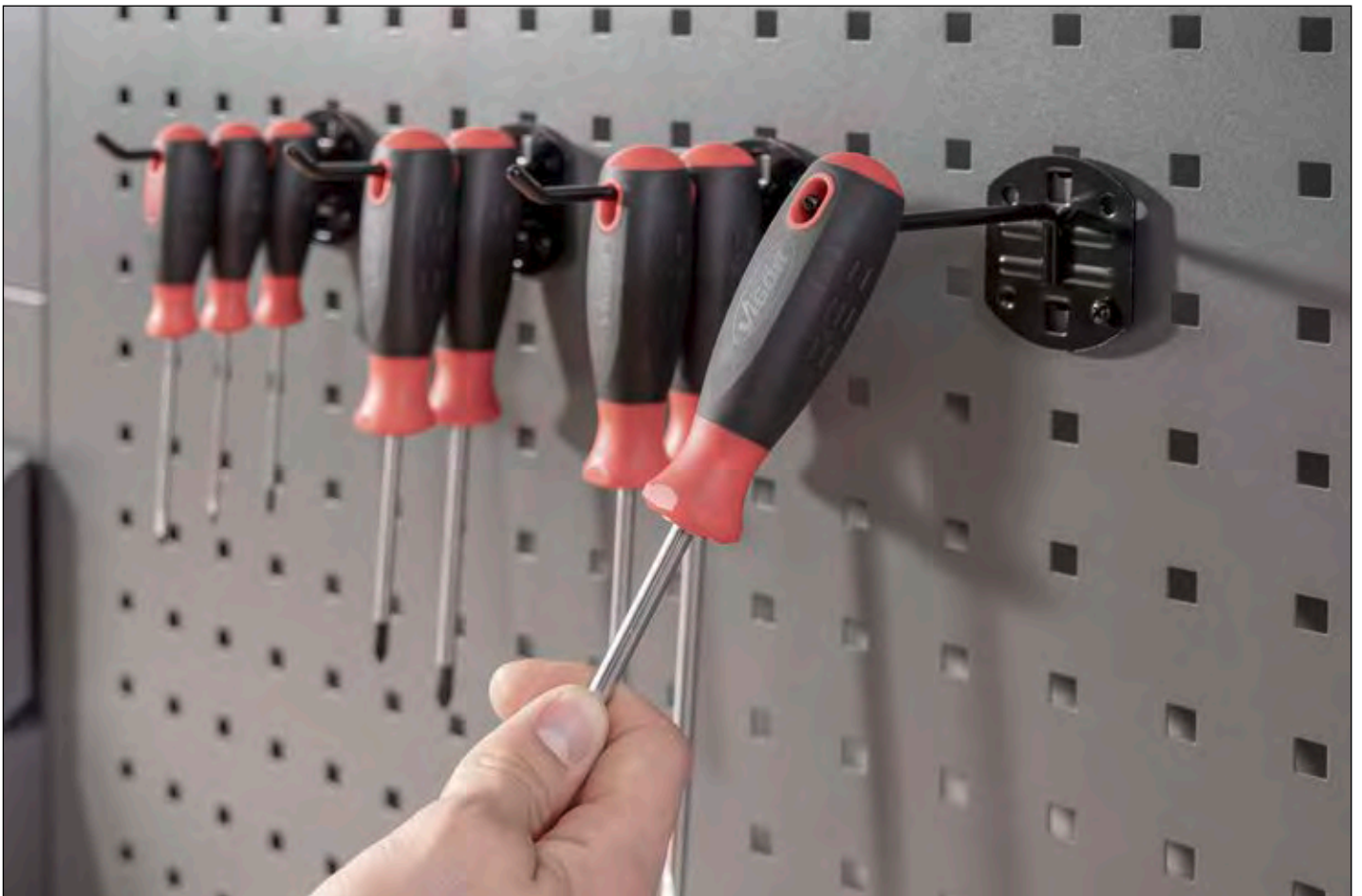

V6150, EAN 4047728**060691**

Schraubstock

- Drehteller
- Pulverbeschichtet
- Backenlänge 150 mm (6 Zoll)
- Gewindetiefe 68 mm
- Spannkraft 2,5 Tonnen
- \approx 13,5 kg

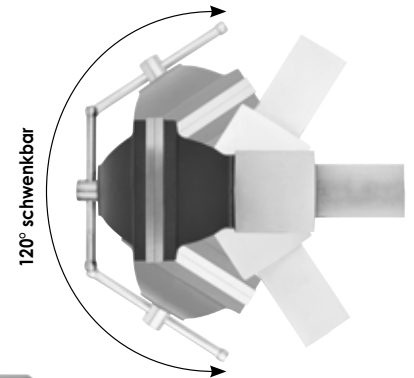
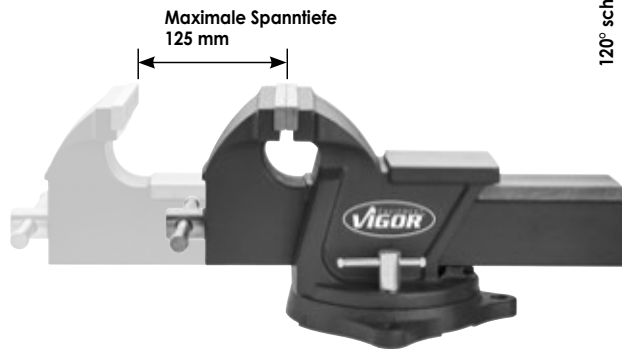
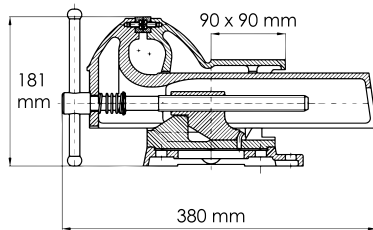
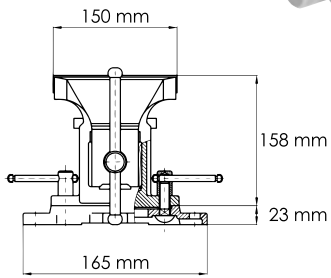



Technische Informationen



L Einlagenmaß schmal
563x393 mm



Füße bis 50 mm höhenverstellbar



XL Einlagenmaß breit
750x393 mm



Befestigungsmaterial im
Lieferumfang enthalten



RAL Farben 9005 · 7005



Zentralverriegelung

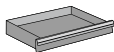

Schmale und flache Schublade
Maße: 569x398x75 mm

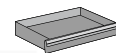

Breite und flache Schublade
Maße: 753x398x75 mm

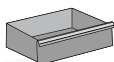

Schmale und hohe Schublade
Maße: 569x398x154 mm



Breite und hohe Schublade
Maße: 753x398x154 mm



Belastbarkeit Schublade: 25 kg

V6000-3P1

Schrankwand-System

- 3-Modul Kombination in breiter Ausführung
- Mit Holz- oder Edelstahl-Arbeitsplatte erhältlich
- Inklusive Seitenverblendung

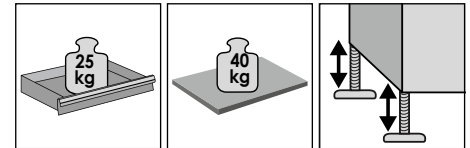
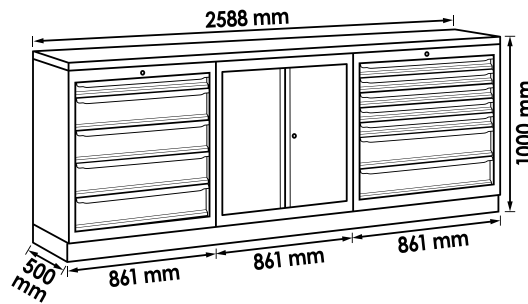

Das Starter-Paket



VIGOR No.	Bezeichnung	EAN 4047728+
V6000-3P1XL	Schrankwand-Kombination · Starter-Paket · Holz	073318
V6000-3P1XL-X	Schrankwand-Kombination · Starter-Paket · Edelstahl	073271

**Alle Pakete mit
Edelstahl- oder Holz-
Arbeitsplatten erhältlich**



V6000-3P2

Schrankwand-System

- 3-Modul Kombination in breiter Ausführung mit Lochwandaufbau und Hängeschränken
- Mit Holz- oder Edelstahl-Arbeitsplatte erhältlich
- Inklusive Seitenverblendung

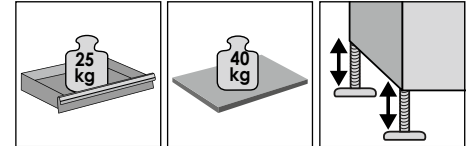
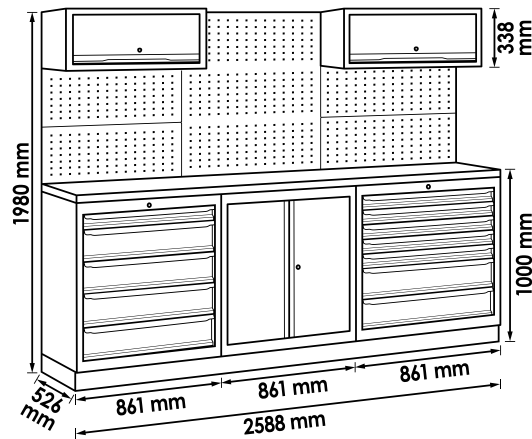

Das Komplett-Paket



VIGOR No.	Bezeichnung	EAN 4047728+
V6000-3P2XL	Schrankwand-Kombination · Komplett-Paket · Holz	073301
V6000-3P2XL-X	Schrankwand-Kombination · Komplett-Paket · Edelstahl	073295

V6000-3

Schrankwand-System

- Schranktür sowohl rechts als auch links montierbar
- Schranktür inklusive Magnet-Verschluss
- Höhenverstellbares Einlegefach
- Alle Türen in der Mitte verstärkt
- Gleichschließende Verriegelung (äquivalent zum Series L Schließsystem)
- Schubladen-Maße entsprechen Series L (569 x 398 x 75 mm flache Schublade, 569 x 398 x 154 mm hohe Schublade)
- Hängeschränke inklusive hochwertigen Dämpfern
- Lochwand für VIGOR Werkzeughaken-Sätze V2517 · V2518 · V2519 · V2520

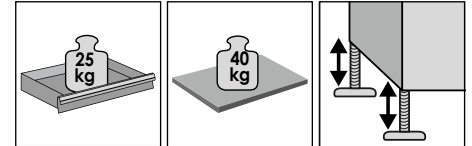
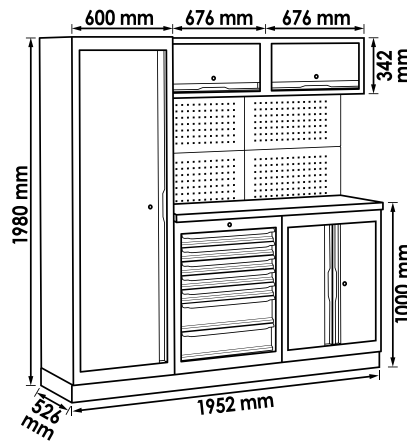

Das Kompakt-Paket



VIGOR No.	Bezeichnung	EAN 4047728+
V6000-3	Schrankwand-Kombination · Kompakt-Paket · Holz	048729
V6000-3-X	Schrankwand-Kombination · Kompakt-Paket · Edelstahl	073288

V6000-029, EAN 4047728076975

Schubladen-Unterschrank · 2 Schubladen

- Einrichtung eines stationären Arbeitsplatzes
- Saubere Aufbewahrung von Werkzeugkästen und Spezialwerkzeug-Koffern
- Gleicht Series L
- Schublade oben (HxBxT): 312x569x397 mm
- Schublade unten (HxBxT): 391x569x397 mm



L

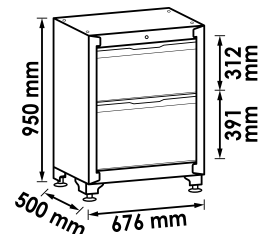

V6000-029XL, EAN 4047728076982

Schubladen-Unterschrank · 2 Schubladen

- Einrichtung eines stationären Arbeitsplatzes
- Saubere Aufbewahrung von Werkzeugkästen und Spezialwerkzeug-Koffern
- Gleicht Series XL
- Schublade oben (HxBxT): 312x753x397 mm
- Schublade unten (HxBxT): 391x753x397 mm



XL

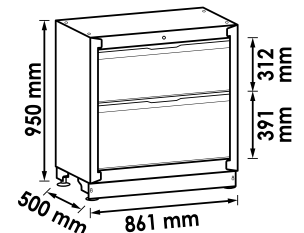

V6000-030, EAN 4047728070140

Schubladen-Unterschrank · 3 Schubladen

- Einrichtung eines stationären Arbeitsplatzes
- Saubere Aufbewahrung von Werkzeugen, Kleinteilen oder diversen Verbrauchsmaterialien
- Für platzsparende und aufgeräumte Sortierung empfehlen wir VIGOR-Trennbleche oder Weichschaumeinlagen
- Gleicht Series L
- Maße (HxBxT)
1. – 3. Schublade: 75x569x398 mm



L

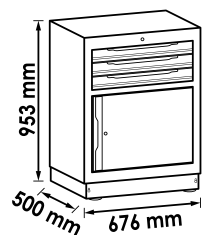

V6000-030XL, EAN 4047728070294

Schubladen-Unterschrank · 3 Schubladen

- Einrichtung eines stationären Arbeitsplatzes
- Saubere Aufbewahrung von Werkzeugen, Kleinteilen oder diversen Verbrauchsmaterialien
- Für platzsparende und aufgeräumte Sortierung empfehlen wir VIGOR-Trennbleche oder Weichschaumeinlagen
- Gleicht Series XL
- Maße (HxBxT)
1. – 3. Schublade: 75x753x398 mm



XL

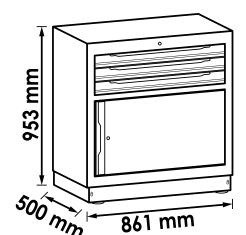

V6000-031, EAN 4047728070157

Schubladen-Unterschrank · 5 Schubladen

- Einrichtung eines stationären Arbeitsplatzes
- Saubere Aufbewahrung von Werkzeugen, Kleinteilen oder diversen Verbrauchsmaterialien
- Für platzsparende und aufgeräumte Sortierung empfehlen wir VIGOR-Trennbleche oder Weichschaumeinlagen
- Gleicht Series L
- Maße (HxBxT)
 1. Schublade: 75x569x398 mm
 2. – 5. Schublade: 154x569x398 mm

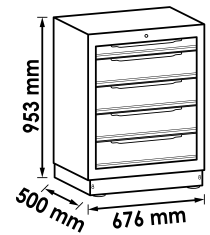

V6000-031XL, EAN 4047728070300

Schubladen-Unterschrank · 5 Schubladen

- Einrichtung eines stationären Arbeitsplatzes
- Saubere Aufbewahrung von Werkzeugen, Kleinteilen oder diversen Verbrauchsmaterialien
- Für platzsparende und aufgeräumte Sortierung empfehlen wir VIGOR-Trennbleche oder Weichschaumeinlagen
- Gleicht Series XL
- Maße (HxBxT)
 1. Schublade: 75x753x398 mm
 2. – 5. Schublade: 154x753x398 mm

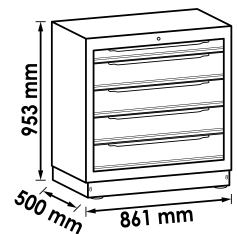

V6000-01, EAN 4047728048248

Schubladen-Unterschrank · 7 Schubladen

- Einrichtung eines stationären Arbeitsplatzes
- Saubere Aufbewahrung von Werkzeugen, Kleinteilen oder diversen Verbrauchsmaterialien
- Für platzsparende und aufgeräumte Sortierung empfehlen wir VIGOR-Trennbleche oder Weichschaumeinlagen
- Gleicht Series L
- Maße (HxBxT)
 1. – 5. Schublade: 75x569x398 mm
 6. – 7. Schublade: 154x569x398 mm

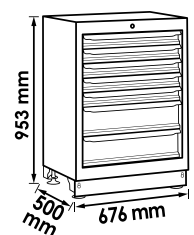

V6000-01XL, EAN 4047728070317

Schubladen-Unterschrank · 7 Schubladen

- Einrichtung eines stationären Arbeitsplatzes
- Saubere Aufbewahrung von Werkzeugen, Kleinteilen oder diversen Verbrauchsmaterialien
- Für platzsparende und aufgeräumte Sortierung empfehlen wir VIGOR-Trennbleche oder Weichschaumeinlagen
- Gleich Series XL
- Maße (HxBxT)
 - 1. – 5. Schublade: 75x753x398 mm
 - 6. – 7. Schublade: 154x753x398 mm



XL

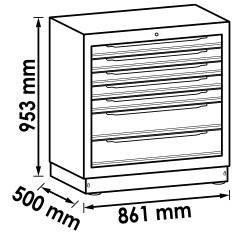

V6000-019, EAN 4047728063883

Werkstattwagen für Schrankwand-System · 7 Schubladen

- Platzsparende Aufbewahrung eines Werkstattwagens unter Schrankwand-Arbeitsplatte
- Speziell für VIGOR Schrankwand-System
- 4 Lenkrollen und Sonderhöhe für platzsparende Unterbringung des Werkstattwagens nach Gebrauch unter Schrankwand-Arbeitsplatte
- Gleich Series L
- Maße (HxBxT)
 - 1. – 5. Schublade: 75x569x398 mm
 - 6. – 7. Schublade: 154x569x398 mm



L

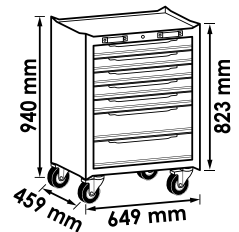

Mit 4 Lenkrollen

V6000-019XL, EAN 4047728070683

Werkstattwagen für Schrankwand-System · 7 Schubladen

- Platzsparende Aufbewahrung eines Werkstattwagens unter Schrankwand-Arbeitsplatte
- Speziell für VIGOR Schrankwand-System
- 4 Lenkrollen und Sonderhöhe für platzsparende Unterbringung des Werkstattwagens nach Gebrauch unter Schrankwand-Arbeitsplatte
- Gleich Series XL
- Maße (HxBxT)
 - 1. – 5. Schublade: 75x753x398 mm
 - 6. – 7. Schublade: 154x753x398 mm



XL

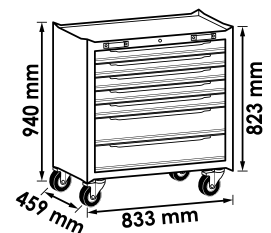

Mit 4 Lenkrollen

V6000-032, EAN 4047728070171

Schubladen-Unterschrank · 8 Schubladen

- Einrichtung eines stationären Arbeitsplatzes
- Saubere Aufbewahrung von Werkzeugen, Kleinteilen oder diversen Verbrauchsmaterialien
- Für platzsparende und aufgeräumte Sortierung empfehlen wir VIGOR-Trennbleche oder Weichschaumeinlagen
- Gleich Series L
- Maße (HxBxT)
 1. – 7. Schublade: 75x569x398 mm
 8. Schublade: 154x569x398 mm



L

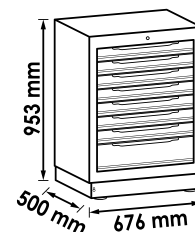

V6000-032XL, EAN 4047728070324

Schubladen-Unterschrank · 8 Schubladen

- Einrichtung eines stationären Arbeitsplatzes
- Saubere Aufbewahrung von Werkzeugen, Kleinteilen oder diversen Verbrauchsmaterialien
- Für platzsparende und aufgeräumte Sortierung empfehlen wir VIGOR-Trennbleche oder Weichschaumeinlagen
- Gleich Series XL
- Maße (HxBxT)
 1. – 7. Schublade: 75x753x398 mm
 8. Schublade: 154x753x398 mm



XL

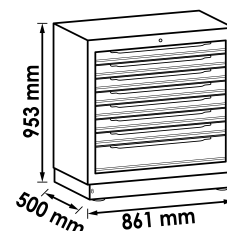

V6000-033, EAN 4047728070195

Abfall-Unterschrank

- Einrichtung eines stationären Arbeitsplatzes
- Mülltrennung direkt am Arbeitsplatz
- Abfallbehälter sicher und sauber im Schrankwandmodul platziert
- Unterschrank mit Durchwurflappe zur raschen Entsorgung von Abfall
- Lieferung inklusive zwei Abfallbehälter
- Fassungsvermögen Abfallbehälter: 35 l
- Gleich Series L



L

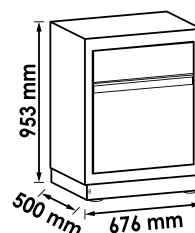

V6000-033XL, EAN 4047728**070331**

Abfall-Unterschrank

- Einrichtung eines stationären Arbeitsplatzes
- Mülltrennung direkt am Arbeitsplatz
- Abfallbehälter sicher und sauber im Schrankwandmodul platziert
- Unterschrank mit Durchwurfsklappe zur raschen Entsorgung von Abfall
- Lieferung inklusive drei Abfallbehälter
- Fassungsvermögen Abfallbehälter: 1 x 25 l · 2 x 35 l
- Gleicht Series L

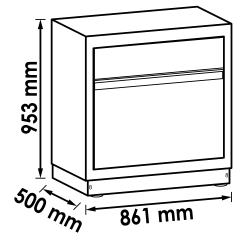

V6000-035, EAN 4047728**074582**

Multifunktions Unterschrank

- Einrichtung eines stationären Arbeitsplatzes
- Abfallbehälter (35 l) mit Durchwurfsklappe zur raschen Müllentsorgung
- Papierrollen-Halterung
- Schublade (Traglast 25 kg) zum Verstauen von Werkzeugen, Kleinteilen oder diversen Verbrauchsmaterialien
- Schubladen-Maße:
 - Links: B 288 x T 397 x H 707 mm
 - Rechts: B 260 x T 397 x H 340 mm

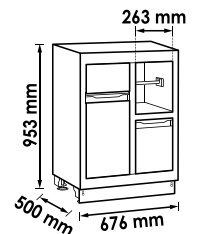

V6000-035XL, EAN 4047728**074599**

Multifunktions Unterschrank

- Einrichtung eines stationären Arbeitsplatzes
- Abfallbehälter (35 l) mit Durchwurfsklappe zur raschen Müllentsorgung
- Papierrollen-Halterung
- Schublade (Traglast 25 kg) zum Verstauen von Werkzeugen, Kleinteilen oder diversen Verbrauchsmaterialien
- Schubladen-Maße:
 - Links: B 268 x T 397 x H 707 mm
 - Rechts: B 471 x T 397 x H 340 mm

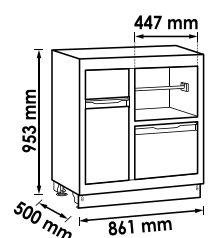

V6000-02, EAN 4047728048255

Doppelflügeltür-Unterschrank

- Einrichtung eines stationären Arbeitsplatzes
- Aufbewahrung von Werkzeugkästen, Arbeitskleidung, Gefäßen oder Kfz-Teilen
- Flügeltür mit Magnet-Verschluss
- Höhenverstellbares Einlegefach
- Innenmaß (LxBxH): 561 x 466,4 x 561 mm
- Erweiterbar mit weiteren Einlegeböden V6000-018
- Gleich Series L

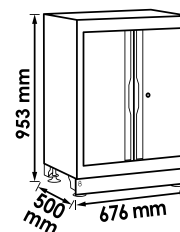

V6000-02XL, EAN 4047728070355

Doppelflügeltür-Unterschrank

- Einrichtung eines stationären Arbeitsplatzes
- Aufbewahrung von Werkzeugkästen, Arbeitskleidung, Gefäßen oder Kfz-Teilen
- Flügeltür mit Magnet-Verschluss
- Höhenverstellbares Einlegefach
- Innenmaß (LxBxH): 561 x 466,4 x 561 mm
- Erweiterbar mit weiteren Einlegeböden V6000-018XL
- Gleich Series XL

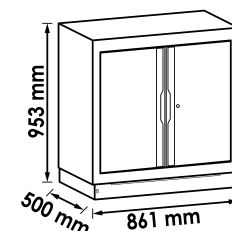

V6000-011, EAN 4047728054904

Eck-Unterschrank

- Eck-Erweiterung für weitere Unterschränke
- Zur Eck-Erweiterung der Schrankwandzeile
- Inklusive Einlegefach

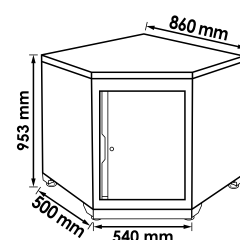

V6000-03, EAN 4047728**048262**

Einzelzügeltür-Schrank · hoch

- Aufbewahrung von Werkzeugkästen, Arbeitskleidung, Gefäßen oder Kfz-Teilen
- Schranktür mit Magnet-Verschluss
- Höhenverstellbares Einlegefach
- Innenmaß (L x B x H): 484 x 478 x 1503,3 / 220,5 mm
- Schranktür sowohl rechts als auch links montierbar
- Erweiterbar mit Einlegeböden V6000-017

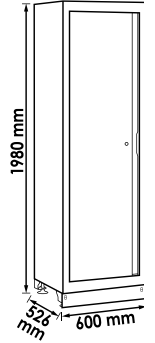

V6000-03XL, EAN 4047728**070362**

Doppelfügeltür-Schrank · hoch

- Aufbewahrung von Werkzeugkästen, Arbeitskleidung, Gefäßen oder Kfz-Teilen
- Schranktür mit Magnet-Verschluss
- Höhenverstellbares Einlegefach
- Innenmaß (L x B x H): 1119 x 510 x 1812 / 220,5 mm
- Schranktür sowohl rechts als auch links montierbar
- Erweiterbar mit Einlegeböden V6000-017XL

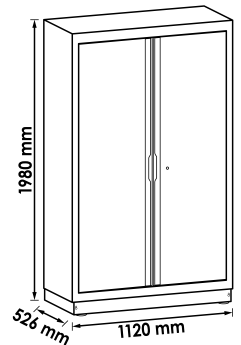

V6000-04, EAN 4047728**048279**

Hängeschrank

- Aufbewahrung von Werkzeugen, Gefäßen oder KFZ-Teilen

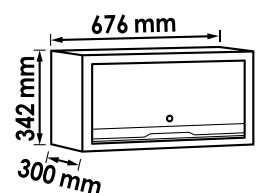

V6000-04XL, EAN 4047728070379

Hängeschrank

- Aufbewahrung von Werkzeugen, Gefäßen oder KFZ-Teilen

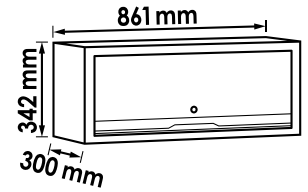

V6000-046, EAN 4047728073615

Doppel Flügeltüren-Hängeschrank

- Optimal in Verbindung mit 700 mm tiefen Arbeitsplatten
- Inklusive 1 höhenverstellbarem Einlegeboden
- Belastbarkeit Einlegeboden: 15 kg
- Belastbarkeit Ablageboden: 20 kg
- Flügeltür drehbar auf Links- oder Rechtsanschlag
- Türen mit Magnetverschluss

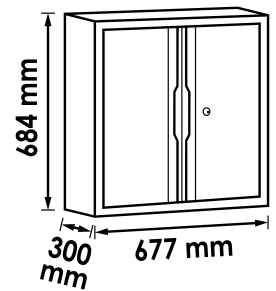

V6000-046XL, EAN 4047728073622

Doppel Flügeltüren-Hängeschrank

- Optimal in Verbindung mit 700 mm tiefen Arbeitsplatten
- Inklusive 1 höhenverstellbarem Einlegeboden
- Belastbarkeit Einlegeboden: 15 kg
- Belastbarkeit Ablageboden: 20 kg
- Flügeltür drehbar auf Links- oder Rechtsanschlag
- Türen mit Magnetverschluss

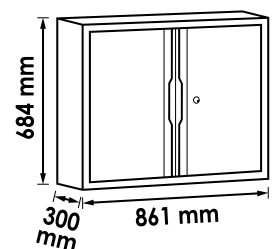

V6000-037, EAN 4047728075015

Brücken-Unterschrank

- Einfache Überbrückung von Arbeitsplatten – Optimal in Verbindung mit 500 mm tiefen Arbeitsplatten
- Schafft viele Arbeitsplatz-Sitzmöglichkeiten und mehr Stauraum in Deiner Werkstatt
- Eine hohe Schublade und ein großes Ablagefach zum Verstauen von Werkzeug
- Belastbarkeit Schublade: 25 kg
- 4 höhenverstellbare (bis 50 mm) Füße

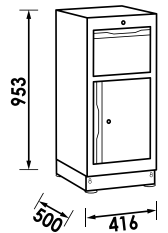

V6000-036, EAN 4047728073356

Stütz-Unterschrank

- Höhenverstellbar
- Sockelblenden im Lieferumfang enthalten
- Türen mit Magnetverschluss
- 1 Regalboden im Lieferumfang enthalten
- Schmale Ausführung · 500 mm



Lochwand Aufbau auch mit Stützfüßen möglich

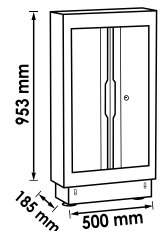

V6000-036XL, EAN 4047728073424

Stütz-Unterschrank

- Höhenverstellbar
- Sockelblenden im Lieferumfang enthalten
- Türen mit Magnetverschluss
- 1 Regalboden im Lieferumfang enthalten
- Tiefe Ausführung · 700 mm



Lochwand Aufbau auch mit Stützfüßen möglich

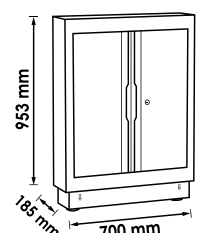

V6000-042, EAN 4047728073363

Unterschrank-Erweiterungsrahmen

- Erweiterung der Unterschränke auf 700 mm Arbeitstiefe
- Ermöglicht Installation von Lochwand- und Hängeschrank-Trägern
- Erweiterungsrahmen werden rückseitig an einen Unterschrank geschraubt
- Schmale Ausführung · 676 mm

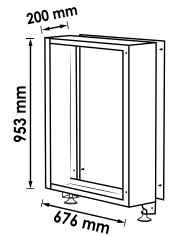
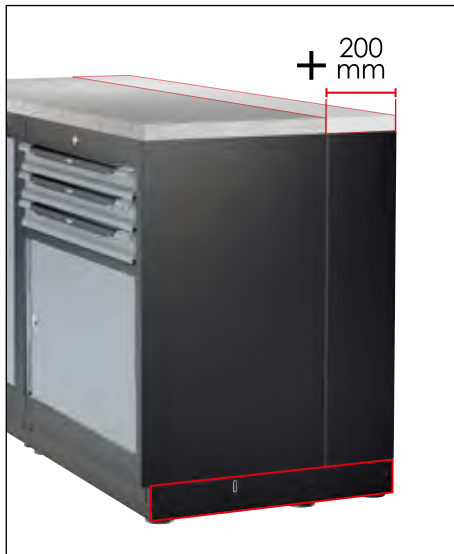

V6000-042XL, EAN 4047728073431

Unterschrank-Erweiterungsrahmen

- Erweiterung der Unterschränke auf 700 mm Arbeitstiefe
- Ermöglicht Installation von Lochwand- und Hängeschrank-Trägern
- Erweiterungsrahmen werden rückseitig an einen Unterschrank geschraubt
- Breite Ausführung · 861 mm

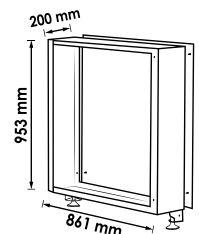

Stützfüße

- Höhenverstellbar
- Sichtschutz-Platte im Lieferumfang enthalten



Lochwandaufbau auch mit Stützfüßen möglich

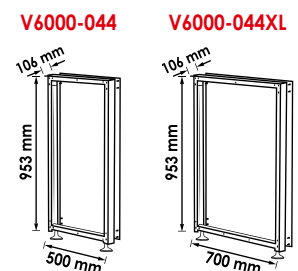

VIGOR No.	Bezeichnung	EAN 4047728+
V6000-044	Stützfüße	073325
V6000-044XL	Stützfüße	073370



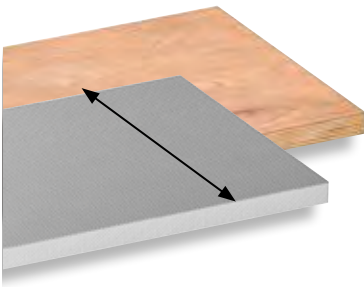

500mm



Arbeitsplatte Holz

• Befestigung auf Schrankwand-Unterschranken



VIGOR No.	Bezeichnung	Länge x Breite x Höhe mm	EAN 4047728+
V6000-0676	Holz-Arbeitsplatte · klein	676 x 500 x 40	073028
V6000-0861	Holz-Arbeitsplatte · klein	861 x 500 x 40	073042
V6000-01541	Holz-Arbeitsplatte kombiniert · mittel	1541 x 500 x 40	073141
V6000-01357	Holz-Arbeitsplatte · mittel	1357 x 500 x 40	073066
V6000-01725	Holz-Arbeitsplatte · mittel	1725 x 500 x 40	073080
V6000-02036	Holz-Arbeitsplatte · groß	2036 x 500 x 40	073103
V6000-02215	Holz-Arbeitsplatte kombiniert · groß	2215 x 500 x 40	073165
V6000-02404	Holz-Arbeitsplatte kombiniert · groß	2404 x 500 x 40	073189
V6000-02588	Holz-Arbeitsplatte · groß	2588 x 500 x 40	073127



Arbeitsplatte Holz

VIGOR No.	Bezeichnung	Länge x Breite x Höhe mm	EAN 4047728+
V6000-0860	Holz-Arbeitsplatte · Fünfeck	883 x 500 x 40	073202

Arbeitsplatte Edelstahl

• Befestigung auf Schrankwand-Unterschranken



VIGOR No.	Bezeichnung	Länge x Breite x Höhe mm	EAN 4047728+
V6000-0676-X	Edelstahl-Arbeitsplatte · klein	676 x 500 x 40	073035
V6000-0861-X	Edelstahl-Arbeitsplatte · klein	861 x 500 x 40	073059
V6000-01541-X	Edelstahl-Arbeitsplatte kombiniert · mittel	1541 x 500 x 40	073158
V6000-01357-X	Edelstahl-Arbeitsplatte · mittel	1357 x 500 x 40	073073
V6000-01725-X	Edelstahl-Arbeitsplatte · mittel	1725 x 500 x 40	073097
V6000-02215-X	Edelstahl-Arbeitsplatte kombiniert · groß	2215 x 500 x 40	073172
V6000-02404-X	Edelstahl-Arbeitsplatte kombiniert · groß	2404 x 500 x 40	073196
V6000-02036-X	Edelstahl-Arbeitsplatte · groß	2036 x 500 x 40	073110
V6000-02588-X	Edelstahl-Arbeitsplatte · groß	2588 x 500 x 40	073134



Arbeitsplatte Edelstahl

VIGOR No.	Bezeichnung	Länge x Breite x Höhe mm	EAN 4047728+
V6000-0860-X	Edelstahl-Arbeitsplatte · Fünfeck	883 x 500 x 40	073219

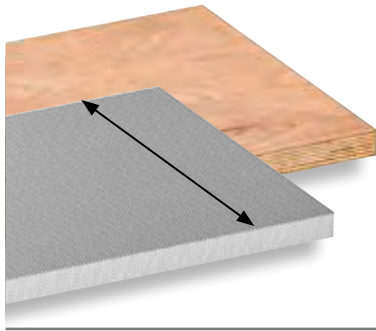

700mm



Arbeitsplatte Holz

• Befestigung auf Schrankwand-Unterschranken



VIGOR No.	Bezeichnung	Länge x Breite x Höhe mm	EAN 4047728+
V6000-0676-D	Arbeitsplatte Holz	676 x 700 x 40	075794
V6000-0861-D	Arbeitsplatte Holz	861 x 700 x 40	075787
V6000-01357-D	Arbeitsplatte Holz	1357 x 700 x 40	073486
V6000-01725-D	Arbeitsplatte Holz	1725 x 700 x 40	073493
V6000-02036-D	Arbeitsplatte Holz	2036 x 700 x 40	073509
V6000-02588-D	Arbeitsplatte Holz	2588 x 700 x 40	073516



Arbeitsplatte Holz

VIGOR No.	Bezeichnung	Länge x Breite x Höhe mm	EAN 4047728+
V6000-01083-D	Holz-Arbeitsplatte · Fünfeck	1083 x 700 x 40	075039

Arbeitsplatte Edelstahl

• Befestigung auf Schrankwand-Unterschranken



VIGOR No.	Bezeichnung	Länge x Breite x Höhe mm	EAN 4047728+
V6000-0676-XD	Arbeitsplatte Edelstahl	676 x 700 x 40	075640
V6000-0861-XD	Arbeitsplatte Edelstahl	881 x 700 x 40	075657
V6000-01357-XD	Arbeitsplatte Edelstahl	1357 x 700 x 40	073448
V6000-01725-XD	Arbeitsplatte Edelstahl	1725 x 700 x 40	073455
V6000-02036-XD	Arbeitsplatte Edelstahl	2036 x 700 x 40	073462
V6000-02588-XD	Arbeitsplatte Edelstahl	2588 x 700 x 40	073479



Arbeitsplatte Edelstahl

VIGOR No.	Bezeichnung	Länge x Breite x Höhe mm	EAN 4047728+
V6000-01083-XD	Edelstahl-Arbeitsplatte · Fünfeck	1083 x 700 x 40	075022



Lochwandplatten Satz

• Kompatibel mit VIGOR Werkzeughaken Sätzen

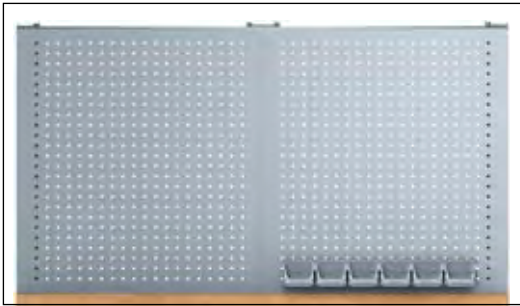
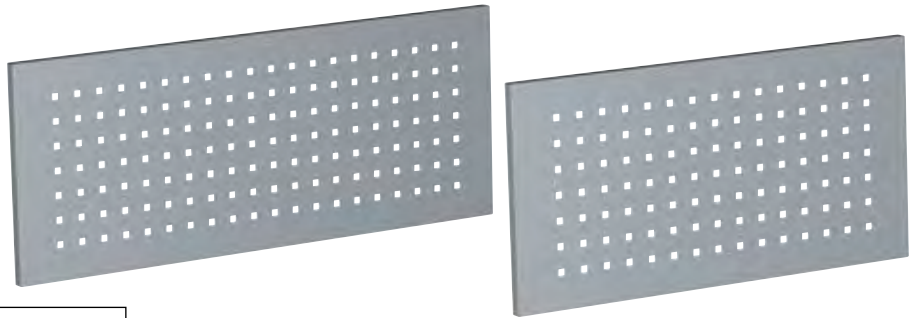

VIGOR No.	Bezeichnung		EAN 4047728+
V6000-05	Lochwandplatten Satz · 676 x 342 mm	2	048286
V6000-015	Lochwandplatten Satz · 861 x 342 mm	2	055260
V6000-015S	Lochwandplatte · 861 x 301 mm	-	072991
V6000-015SXL	Lochwandplatte · 861 x 985 mm	-	072984
V6000-048	Eck-Lochwandplatte	-	076135
V6000-05S	Lochwandplatte · 676 x 301 mm	-	073011
V6000-05SXL	Lochwandplatte · 676 x 985 mm	-	073004

Lochwandplatte mit Netzversorgung

- Kippschalter zur Deaktivierung der Stromversorgung
- Nur für die unterste Ebene geeignet
- Magnetische Abdeckung schützt vor Verschmutzung
- Integrierte 3-fach Schuko Steckdosenleiste 230 V, 50/60 Hz
- 4 USB-Ports (4x 2,1 A)



VIGOR No.	Bezeichnung	EAN 4047728+
V6000-05SP	Lochwandplatte mit Netzversorgung 676 mm	073981
V6000-015SP	Lochwandplatte mit Netzversorgung 861 mm	073998

Regalboden



VIGOR No.	Bezeichnung		Länge x Breite x Höhe mm	EAN 4047728+
V6000-017	Regalboden Satz für Einzel-Flügel für-Schrank V6000-03	2	524x476 x 13	055420
V6000-017XL	Regalboden Satz für Doppel-Flügel für-Schrank für V6000-03XL	2	1045x476 x 13	070669

Regalboden

- Regalboden für V6000-02 · V6000-02XL



VIGOR No.	Bezeichnung	Länge x Breite x Höhe mm	EAN 4047728+
V6000-018	Regalboden für Doppel-Flügelür-Unterschrank V6000-02	601 x 464 x 13	059275
V6000-018XL	Regalboden für Doppel-Flügelür-Unterschrank	785 x 464 x 13	070652

V6000-043, EAN 4047728073813

Sockelblende für Unterschrank mit Erweiterungsrahmen

- Zum sauberen Abschließen der Seitenwände aller Unterschränke mit Erweiterungsrahmen
- Verhindert Eindringen von Staub und Dreck
- Lieferung inklusive Schrauben
- Sockelblende · 650 mm

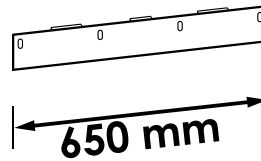

V6000-09, EAN 4047728048422

Sockelblende für Hochschränke

- Zum sauberen Abschließen der Seitenwände aller Hochschränke
- Verhindert Eindringen von Staub und Dreck
- Lieferung inklusive Schrauben

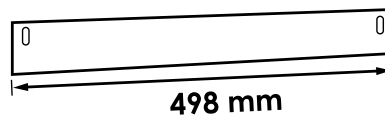
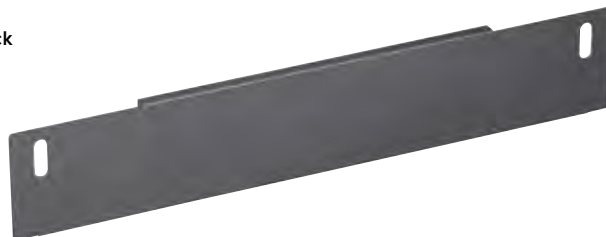

V6000-010, EAN 4047728048439

Sockelblende für Unterschränke

- Zum sauberen Abschließen der Seitenwände aller Unterschränke
- Verhindert Eindringen von Staub und Dreck
- Lieferung inklusive Schrauben

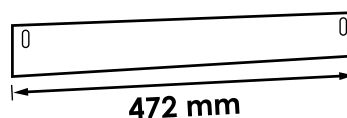

V6000-041/4, EAN 4047728070676

Regalboden-Träger Satz

- Zur Befestigung von Einlegeböden



V6000-020, EAN 4047728069588

Ersatzschloss für VIGOR Schrankwand-System

- Inklusive 2 Schlüssel
- Für alle VIGOR Flügeltüren-Schränke:
V6000-030 · V6000-030XL · V6000-02 · V6000-02XL · V6000-03 · V6000-03XL · V6000-011 · V6000-046 · V6000-046XL



V6000-040/4, EAN 4047728070645

Verbindungsplättchen Satz

- Rückseitige Verbindung von zwei Unterschränken
- Inhalt: 4 Verbindungsplättchen inklusive Schrauben und Muttern

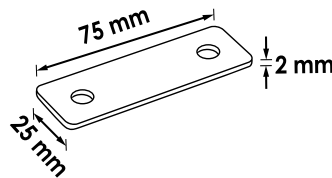

V6000-050, EAN 4047728073417

Regalboden

- Einfache Aufhängung an 9x9 mm Lochwandraster
- Maximale Belastung: 6 kg

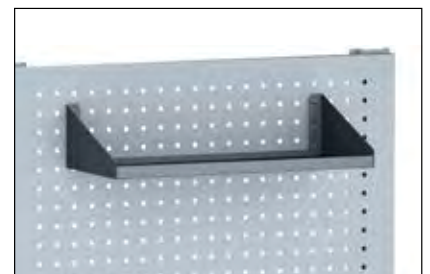
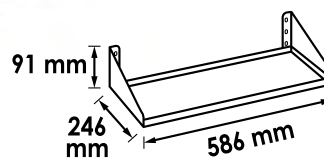

V6000-051, EAN 4047728073349

Dosenhalter

- Zur Lagerung von Dosen
- Einfache Aufhängung an 9x9 mm Lochwandraster

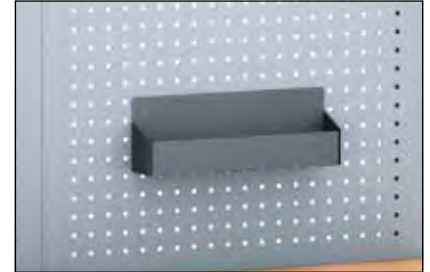
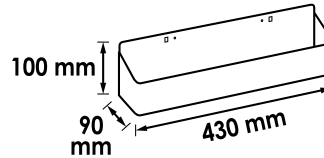

V6000-052, EAN 4047728073653

Aufhängeleiste

- Nur in Verbindung mit V6000-053
- Zum Aufhängen von insgesamt 6 Sichtlagerkästen
- Einfache Aufhängung an 9x9 mm Lochwandraster

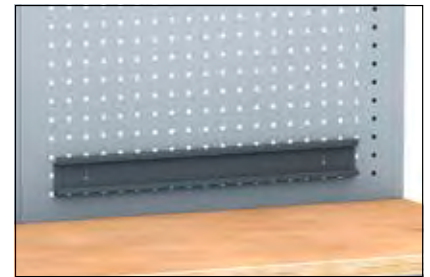
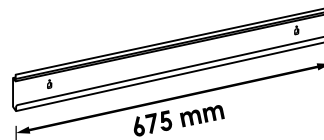
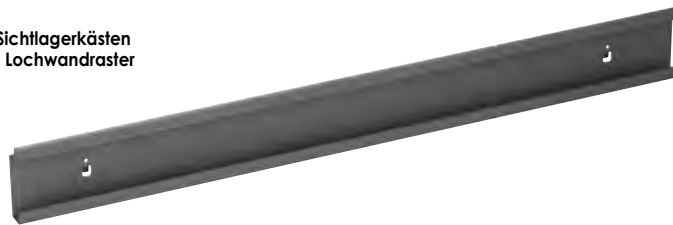

V6000-053, EAN 4047728074223

Sichtlagerkasten Satz

- Zur Lagerung von Kleinteilen
- Optimal in Verbindung mit V6000-052
- 3 Sichtlagerkästen im Lieferumfang enthalten
- Maximale Belastung: 3 kg

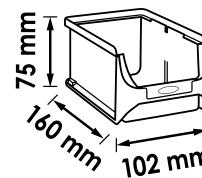

V6000-054, EAN 4047728074001

Monitor-Halter

- Kabelführung am Halter
- Halterplatte und Befestigungsmaterial im Lieferumfang enthalten
- Gesamtausladung:
 - Kurzer Schwenkarm: 175 mm
 - Langer Schwenkarm: 265 mm
 - Kurz und lang kombiniert: 350 mm
- Einfache Aufhängung an 9x9 mm Lochwandraster
- Maximale Belastung: 5 kg
- 180° schwenkbar

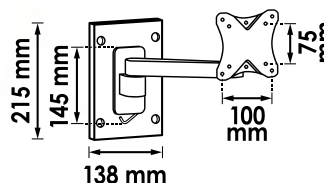
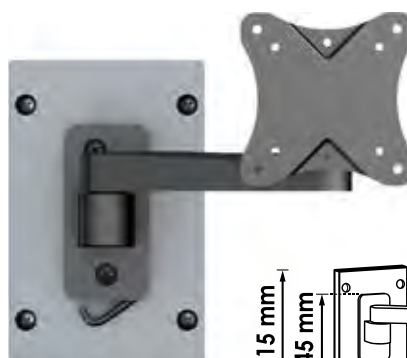

V6000-055, EAN 4047728077118

Drehmomentschlüssel-Halter

- Für gängige Drehmomentschlüssel
- Mit Kantenschutz
- Öffnungsweite 19,5 mm



V6000-055XL, EAN 4047728077125

Drehmomentschlüssel-Halter

- Für gängige Drehmomentschlüssel
- Mit Kantenschutz
- Öffnungsweite 26 mm



V6000-047LR, EAN 4047728076128

Lochwandträger Satz · links und rechts

- Zur Befestigung von Lochwandplatten und Hängeschränken
- Passend für alle VIGOR Lochwandplatten
- Schrankwandaufbau von vorne dank zusätzlich eingesetzter Gewindehülsen
- Vollflächige Aufhängung von Lochwandplatten möglich
- Zusatzlochungen für Wandmontage vorhanden
- Befestigung rückseitig an den Außenpositionen der Unterschränke



V6000-047M, EAN 4047728076111

Lochwandträger · mittig

- Zur Befestigung von Lochwandplatten und Hängeschränken
- Passend für alle VIGOR Lochwandplatten
- Schrankwandaufbau von vorne dank zusätzlich eingesetzter Gewindehülsen
- Vollflächige Aufhängung von Lochwandplatten möglich
- Zusatzlochungen für Wandmontage vorhanden
- Befestigung rückseitig an den Innenpositionen der Unterschränke

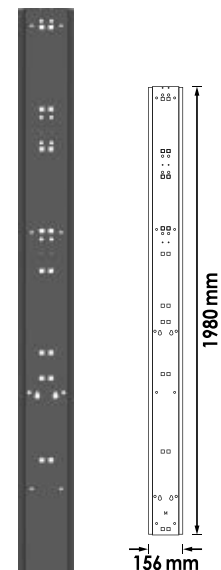
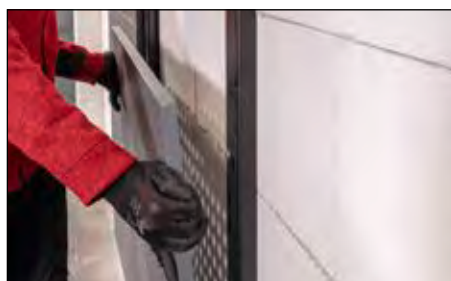
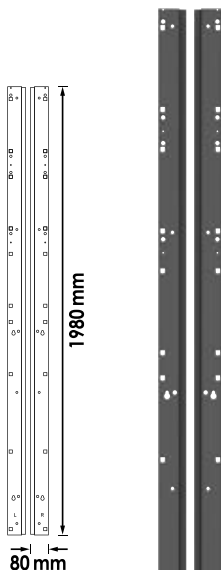

V7283, EAN 4047728072847

LED Lichtleiste · Erweiterung

- Optimale Beleuchtung für Werkstatt, Keller, Wohnraum oder Gartenhütten
- Magnetische Rückseite zur Befestigung an eisenhaltigen Untergründen
- Klebestreifen für nicht magnetische Untergründe im Lieferumfang enthalten
- Robustes Aluminium-Gehäuse
- Länge LED-Lichtleiste: 527 mm
- Gesamtlänge (inklusive Kabel): 2527 mm
- Leistung: 1000 lm
- Maximal 3 LED-Lichtleisten pro Netzteil kombinierbar

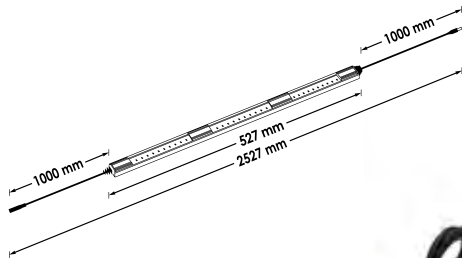

V7283/2, EAN 4047728072830

LED Lichtleiste · Basis Satz

- Optimale Beleuchtung für Werkstatt, Keller, Wohnraum oder Gartenhütten
- Magnetische Rückseite zur Befestigung an eisenhaltigen Untergründen
- Klebestreifen für nicht magnetische Untergründe im Lieferumfang enthalten
- Robustes Aluminium-Gehäuse
- Länge LED-Lichtleiste: 527 mm
- Gesamtlänge (inklusive Kabel): 2527 mm
- Leistung: 1000 lm
- Maximal 3 LED-Lichtleisten pro Netzteil kombinierbar
- Inklusive ON/OFF Schalter
- Inklusive Netzteil 230 V, 1,5 A Output

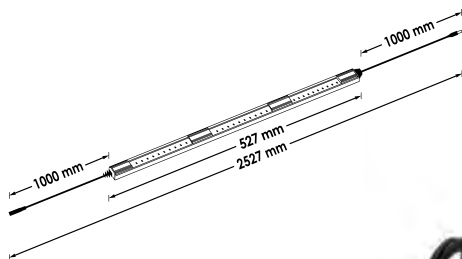

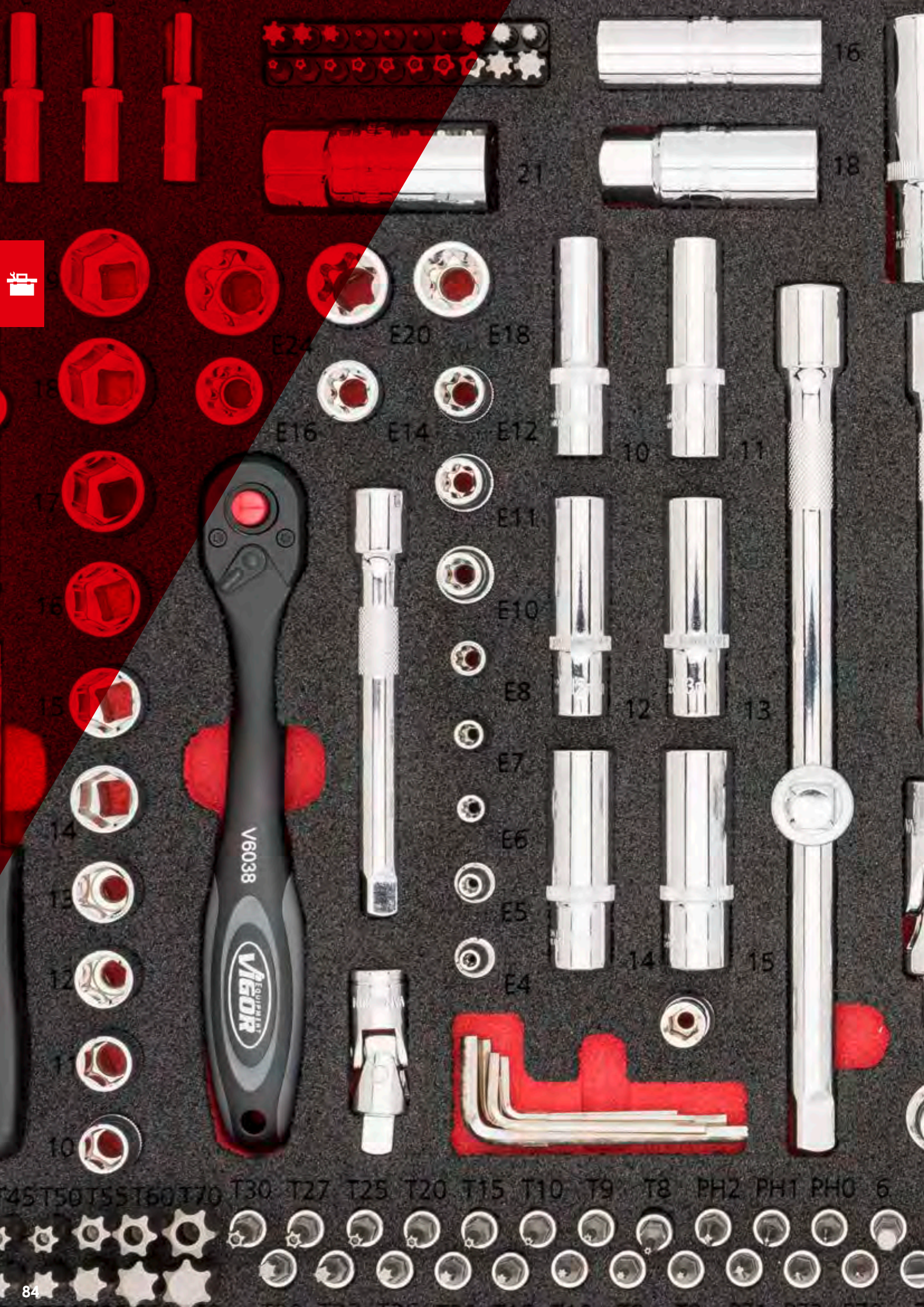

电

T45 T50 T55 T60 T70 T30 T27 T25 T20 T15 T10 T9 T8 PH2 PH1 PH0 6

Werkzeug- aufbewahrung

Multiboxen

86-87

Weichschaum-Einlagen

88-115

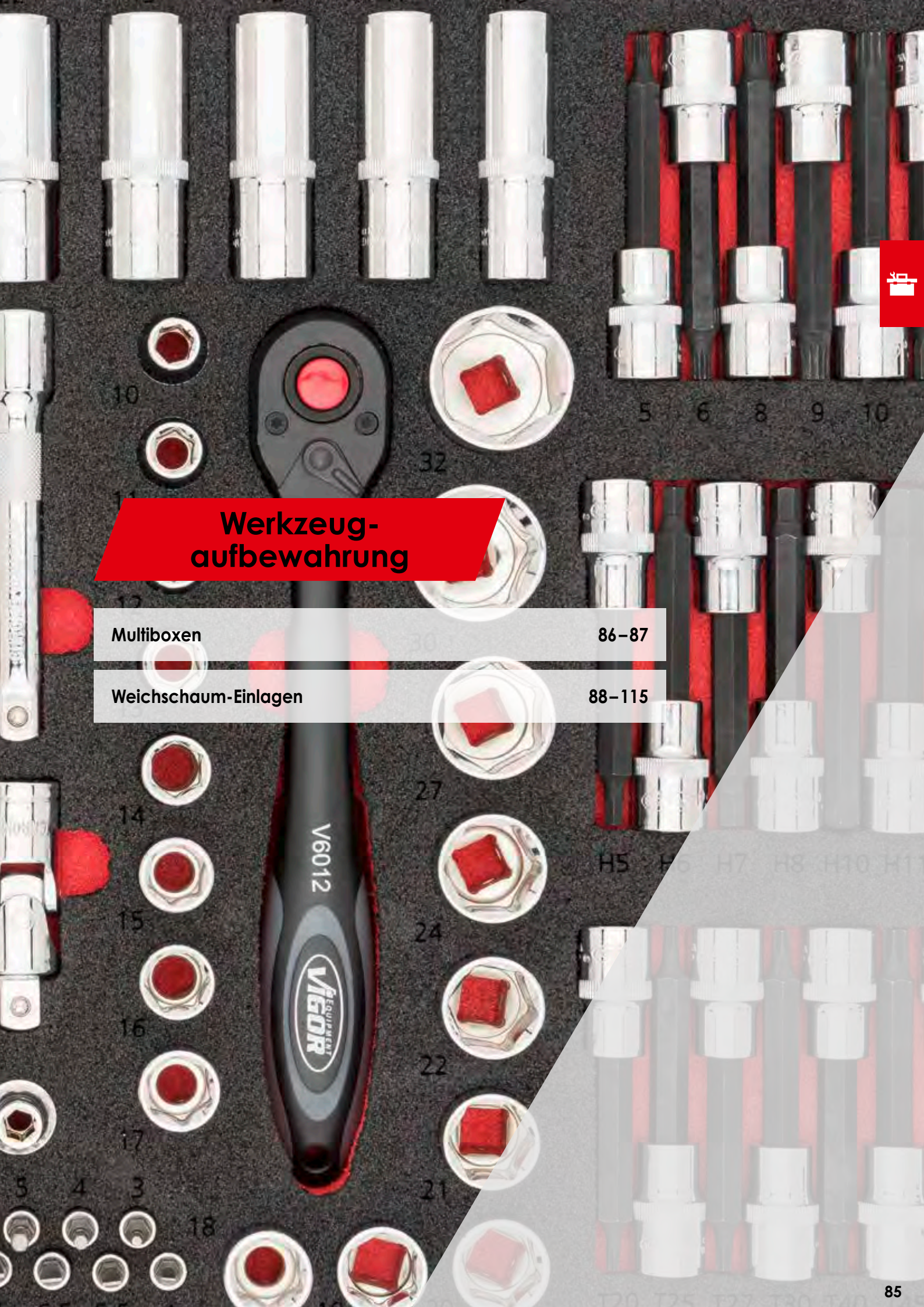

V4700-L, EAN 4047728**046794**

Multibox-L · leer

- Leichtgewichtige Kunststoff-Box
- Maximale Belastbarkeit: 90 kg

M

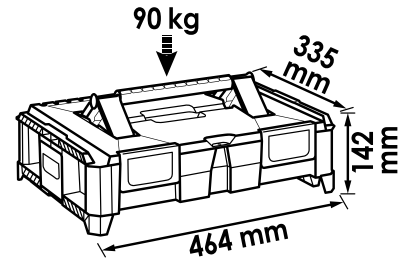

V4700-XL, EAN 4047728**049269**

Multibox-XL · leer

- Leichtgewichtige Kunststoff-Box
- Maximale Belastbarkeit: 90 kg

M

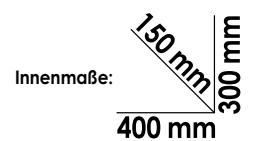
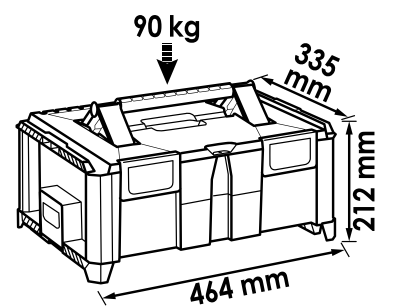

V4700-XXL, EAN 4047728**049276**

Multibox-XXL · leer

- Leichtgewichtige Kunststoff-Box
- Maximale Belastbarkeit: 90 kg

M

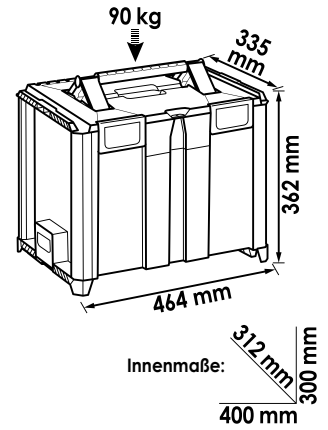

V4700-A, EAN 4047728**075077**

Erweiterungssatz Multibox

- Zum Kombinieren der VIGOR Multiboxen mit Fremdfabrikaten
- Einfaches Click-System für schnelle Verbindungen
- Erweiterungssatz Multibox



V4700-R, EAN 4047728**049283**

Rollbrett für Multibox

- Rollbrett für V4700-L · V4700-XL und V4700-XXL
- Maximale Belastbarkeit: 200 kg

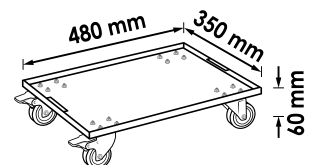

Erklärung Schubladen-Piktogramme

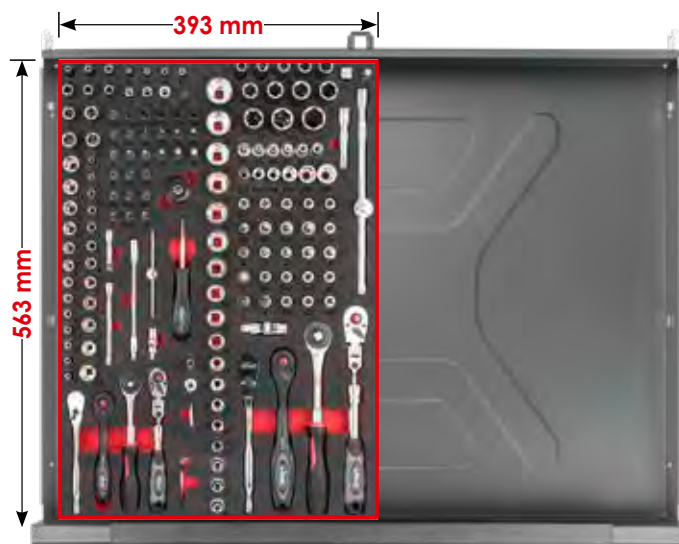
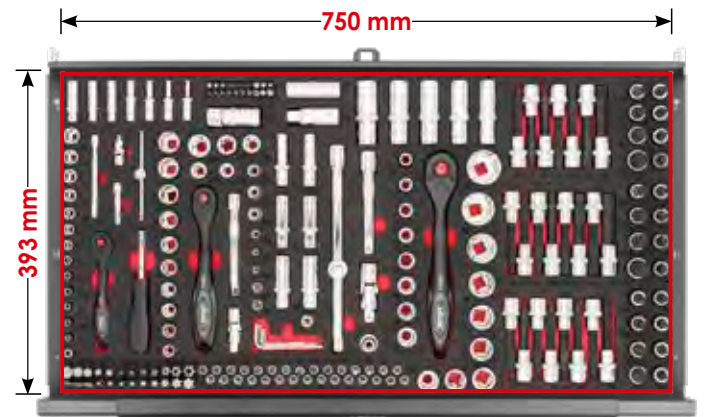
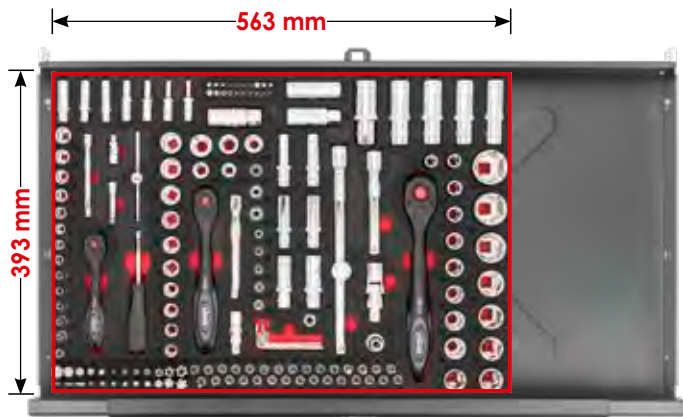
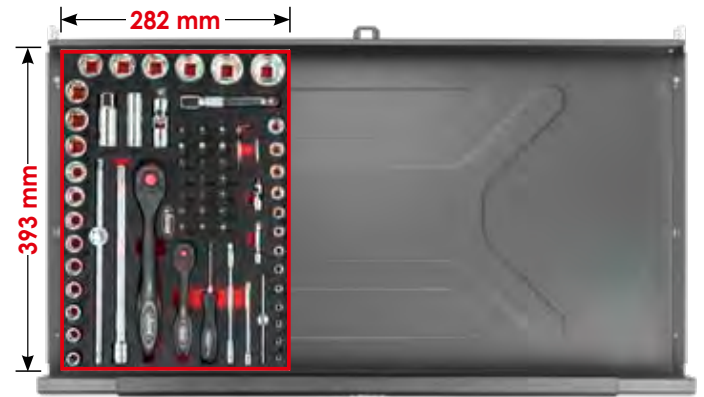

Weichschaum-Einlagen



V4971, EAN 4047728049719
Steckschlüssel-Werkzeug Satz



XX	■		Ausführung	SW
13 x	6.3	1/4		4 · 4.5 · 5 · 5.5 · 6 · 7 · 8 · 9 · 10 · 11 · 12 · 13 · 14 mm
7 x	6.3	1/4		4 · 5 · 6 · 7 · 8 · 9 · 10 mm
7 x	6.3	1/4		E4 · E5 · E6 · E7 · E8 · E10 · E11
6 x	6.3	1/4		3 · 4 · 5 · 6 · 7 · 8 mm
3 x	6.3	1/4		PH1 · PH2 · PH3
3 x	6.3	1/4		0.8x4-1x5.5-1.2x7 mm
3 x	6.3	1/4		PZ1 · PZ2 · PZ3
6 x	6.3	1/4		T10 · T15 · T20 · T25 · T30 · T40

XX	■		Ausführung	SW
7 x	6.3	1/4		T9H · T10H · T15H · T20H · T25H · T27H · T30H
1 x	-	6.3	1/4	150 mm
1 x	6.3	1/4		40 mm
1 x	10	3/8		27 mm
1 x	6.3	1/4		110 mm
1 x	6.3	1/4		145 mm
1 x	6.3	1/4		50 mm
1 x	6.3	1/4		100 mm
2 x	-			1.3 · 2 mm
2 x	-	-	-	45.5 · 51 mm
1 x	-	6.3	1/4	150 mm

V4971-L, EAN 4047728049702
Weichschaum-Einlage · leer



V4973, EAN 4047728049733
Steckschlüssel-Werkzeug Satz



XX	■		Ausführung	SW
18 x	10	3/8		6 · 7 · 8 · 9 · 10 · 11 · 12 · 13 · 14 · 15 · 16 · 17 · 18 · 19 · 20 · 21 · 22 · 24 mm
10 x	10	3/8		8 · 9 · 10 · 11 · 12 · 13 · 14 · 15 · 17 · 19 mm
7 x	10	3/8		3 · 4 · 5 · 6 · 7 · 8 · 10 mm
3 x	10	3/8		0.8x5.5-1x7-1.2x8 mm
3 x	10	3/8		PH1 · PH2 · PH3
3 x	10	3/8		PZ1 · PZ2 · PZ3

XX	■		Ausführung	SW
9 x	10	3/8		T15 · T20 · T25 · T27 · T30 · T40 · T45 · T50 · T55
2 x	10	3/8		16 · 21 mm
1 x	10	3/8		28 mm
1 x	12.5	1/2		40 mm
1 x	10	3/8		50 mm
1 x	10	3/8		75 mm
1 x	10	3/8		250 mm
1 x	-	10	3/8	198 mm

V4973-L, EAN 4047728049726
Weichschaum-Einlage · leer



V4975, EAN 4047728049757
Steckschlüssel-Werkzeug Satz



XX	■		Ausführung	SW
18 x	12.5	1/2		10 · 11 · 12 · 13 · 14 · 15 · 16 · 17 · 18 · 19 · 20 · 21 · 22 · 23 · 24 · 27 · 30 · 32 mm
2 x	12.5	1/2		16 · 21 mm
1 x	-	12.5	1/2	250 mm

XX	■		Ausführung	SW
1 x	12.5	1/2		75 mm
1 x	12.5	1/2		125 mm
1 x	12.5	1/2		250 mm
1 x	-	12.5	1/2	250 mm

V4975-L, EAN 4047728049740
Weichschaum-Einlage · leer



V7323, EAN 4047728073240

Steckschlüssel Satz



XX	■		Ausführung	SW
3 x	6.3	1/4		11 · 12 · 13 mm
5 x	10	3/8		E10 · E12 · E14 · E16 · E18
8 x	12.5	1/2		10 · 12 · 14 · 16 · 17 · 18 · 19 · 22 mm

XX	■		Ausführung	SW
5 x	12.5	1/2		E14 · E16 · E18 · E20 · E22
5 x	12.5	1/2		15 · 17 · 19 · 21 · 22 mm

V7323-L, EAN 4047728073233

Weichschaum-Einlage · leer

V5602, EAN 4047728056021

Schlagschrauber Steckschlüsseleinsatz Satz



XX	■		Ausführung	SW
13 x	12.5	1/2		10 · 11 · 12 · 13 · 14 · 15 · 16 · 17 · 18 · 19 · 21 · 22 · 24 mm

XX	■		Ausführung	SW
13 x	12.5	1/2		10 · 11 · 12 · 13 · 14 · 15 · 16 · 17 · 18 · 19 · 21 · 22 · 24 mm

V5602-L, EAN 4047728056038

Weichschaum-Einlage · leer

V5099, EAN 4047728050999

Schraubendreher-Einsatz Satz



XX	■		Ausführung	SW
10 x	12.5	1/2		T20 · T25 · T27 · T30 · T40 · T45 · T50 · T55 · T60 · T70
9 x	12.5	1/2		M5 · M6 · M7 · M8 · M9 · M10 · M12 · M13 · M14

XX	■		Ausführung	SW
9 x	12.5	1/2		5 · 6 · 7 · 8 · 10 · 12 · 14 · 17 · 19 mm
8 x	12.5	1/2		M5 · M6 · M8 · M9 · M10 · M12 · M14 · M16

V5099-L, EAN 4047728051002

Weichschaum-Einlage · leer

V5095, EAN 4047728050951

T Schraubendreher-Einsatz Satz



XX	■		Ausführung	SW
6 x	12.5	1/2		T40 · T45 · T50 · T55 · T60 · T70
10 x	12.5	1/2		T20 · T25 · T27 · T30 · T40 · T45 · T50 · T55 · T60 · T70

XX	■		Ausführung	SW
10 x	12.5	1/2		T20 · T25 · T27 · T30 · T40 · T45 · T50 · T55 · T60 · T70

V5095-L, EAN 4047728050968

Weichschaum-Einlage · leer

Weichschaum-Einlagen



V5091, EAN 4047728050913
 Innenvielzahn Schraubendreher-
 Einsatz Satz (XZN)



XX			Ausführung	SW
7 x	125	1/2		M5 · M6 · M8 · M9 · M10 · M12 · M14
7 x	125	1/2		M5 · M6 · M8 · M9 · M10 · M12 · M14

XX			Ausführung	SW
8 x	125	1/2		M5 · M6 · M8 · M9 · M10 · M12 · M14 · M16

V5091-L, EAN 4047728050920
 Weichschaum-Einlage · leer



V5097, EAN 4047728050975
 Innensechskant Schraubendreher-Einsatz Satz



XX			Ausführung	SW
7 x	125	1/2		5 · 6 · 7 · 8 · 10 · 12 · 14 mm
8 x	125	1/2		5 · 6 · 7 · 8 · 10 · 11 · 12 · 13 mm

XX			Ausführung	SW
9 x	125	1/2		5 · 6 · 7 · 8 · 10 · 12 · 14 · 17 · 19 mm

V5097-L, EAN 4047728050982
 Weichschaum-Einlage · leer



V6721, EAN 4047728067461
 Doppel-Maulschlüssel Satz



XX		Ausführung	SW
12 x			6 x 7 · 8 x 9 · 10 x 11 · 12 x 13 · 14 x 15 · 16 x 17 · 18 x 19 · 20 x 22 · 21 x 23 · 24 x 27 · 25 x 28 · 30 x 32 mm



V6721-L, EAN 4047728067218
 Weichschaum-Einlage · leer



V6723, EAN 4047728067485
 Ring-Maulschlüssel Satz



XX		Ausführung	SW
18 x			6 · 7 · 8 · 9 · 10 · 11 · 12 · 13 · 14 · 15 · 16 · 17 · 18 · 19 · 21 · 22 · 24 · 27 mm



V6723-L, EAN 4047728067232
 Weichschaum-Einlage · leer



V6722, EAN 4047728**067478**
Doppel-Ringschlüssel Satz

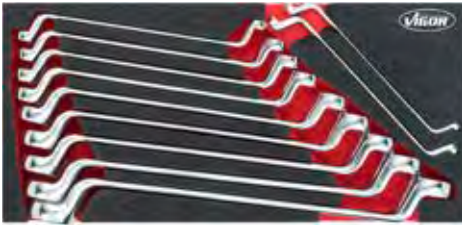

XX	Ausführung	SW
11 x		6 x 7 · 8 x 9 · 10 x 11 · 12 x 13 · 14 x 15 · 16 x 17 · 18 x 19 · 20 x 22 · 21 x 23 · 24 x 27 · 25 x 28 mm



V6722-L, EAN 4047728**067225**
Weichschaum-Einlage · leer



V5075, EAN 4047728**050753**
Ratschen Ring-Maulschlüssel Satz · kurz



XX	Ausführung	SW
12 x		8 · 9 · 10 · 11 · 12 · 13 · 14 · 15 · 16 · 17 · 18 · 19 mm



V5075-L, EAN 4047728**050760**
Weichschaum-Einlage · leer



V4987, EAN 4047728**049870**
Ratschen Ring-Maulschlüssel Satz

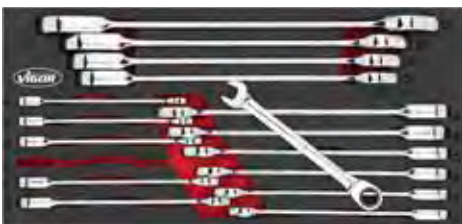

XX	Ausführung	SW
16 x		8 · 9 · 10 · 11 · 12 · 13 · 14 · 15 · 16 · 17 · 18 · 19 · 21 · 22 · 24 · 27 mm



V4987-L, EAN 4047728**049863**
Weichschaum-Einlage · leer



V5077, EAN 4047728**050777**
Gelenk Ratschen Ring-Maulschlüssel Satz



XX	Ausführung	SW
12 x		8 · 9 · 10 · 11 · 12 · 13 · 14 · 15 · 16 · 17 · 18 · 19 mm



V5077-L, EAN 4047728**050784**
Weichschaum-Einlage · leer



Weichschaum-Einlagen



V4989, EAN 4047728**049894**
Schraubendreher Satz



XX	Ausführung	SW
6 x		0.6x3 · 0.8x4 · 1x5.5 · 1.2x6.5 · 1.6x8 · 1.6x10 mm
1 x		PH3
1 x		1x5.5 mm

XX	Ausführung	SW
1 x		PH2
3 x		PH1 · PH2 · PH3

V4989-L, EAN 4047728**049887**
Weichschaum-Einlage · leer

V5068, EAN 4047728**050685**
Schraubendreher Satz mit Schlagkappe



XX	Ausführung	SW
3 x		PH1 · PH2 · PH3

XX	Ausführung	SW
7 x		0.6x3.5 · 1x4.5 · 1x5.5 · 1.2x6.5 · 1.6x8 · 1.6x10 · 2x12 mm

V5068-L, EAN 4047728**050678**
Weichschaum-Einlage · leer

V4991, EAN 4047728**049917**
T Schraubendreher Satz

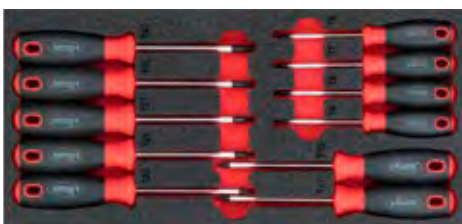

XX	Ausführung	SW
11 x		T6 · T7 · T8 · T9 · T10 · T15 · T20 · T25 · T27 · T30 · T40

V4991-L, EAN 4047728**049900**
Weichschaum-Einlage · leer

V4995, EAN 4047728**049955**
Doppelgelenk Zangen Satz



XX	Ausführung	SW
1 x		340 mm
1 x		335 mm

XX	Ausführung	SW
1 x		300 mm
1 x		290 mm

V4995-L, EAN 4047728**049948**
Weichschaum-Einlage · leer



V5004, EAN 4047728050043

Grip-Zangen Satz



XX	Ausführung	SW
1 x		16 - 27 mm
1 x		11 - 19 mm
1 x		125 mm

XX	Ausführung	SW
1 x		250 mm
1 x		150 mm

V5004-L, EAN 4047728050005

Weichschaum-Einlage · leer



V6222, EAN 4047728062374

Hammer-, Meißel- und Splintreiber Satz



XX	Ausführung	SW
1 x		Ø 4 mm
1 x		18 mm
1 x		6 mm

XX	Ausführung	SW
1 x		500 g
7 x		Ø 2 · 3 · 4 · 5 · 6 · 7 · 8 mm

V6222-L, EAN 4047728062633

Weichschaum-Einlage · leer



V5006, EAN 4047728050067

Hammer- und Meißel Satz



XX	Ausführung	SW
1 x		6 mm
1 x		18 mm
1 x		Ø 4 mm

XX	Ausführung	SW
6 x		Ø 2 · 3 · 4 · 5 · 6 · 8 mm
1 x		Ø 40 mm
1 x		800 g

V5006-L, EAN 4047728050050

Weichschaum-Einlage · leer



V5070, EAN 4047728050708

Haken- und Schaber Satz



XX	Ausführung	SW
1 x		130 mm
1 x		130 mm
1 x		130 mm
1 x		130 mm
1 x		260 mm

XX	Ausführung	SW
1 x		260 mm
1 x		260 mm
1 x		260 mm
1 x		260 mm

V5070-L, EAN 4047728050692

Weichschaum-Einlage · leer



Weichschaum-Einlagen



V5017, EAN 4047728050173
Schaber Satz



XX	Ausführung	SW
1 x		22 mm
1 x		32 mm
1 x		32 mm
1 x		20 mm

XX	Ausführung	SW
1 x		20 mm
1 x		40 mm
1 x		10 x

V5017-L, EAN 4047728050166
Weichschaum-Einlage · leer

V5072, EAN 4047728050722
Feilen Satz



XX	Ausführung	SW
1 x		310 mm
1 x		310 mm
1 x		310 mm

XX	Ausführung	SW
1 x		310 mm
1 x		310 mm

V5072-L, EAN 4047728050715
Weichschaum-Einlage · leer

V5011, EAN 4047728050111
VDE Steckschlüssel Satz



XX	Ausführung	SW
9 x		8 · 10 · 12 · 13 · 14 · 17 · 19 · 22 · 24 mm
3 x		5 · 6 · 8 mm

XX	Ausführung	SW
1 x		125 mm
1 x		255 mm

V5011-L, EAN 4047728050104
Weichschaum-Einlage · leer

V5013, EAN 4047728050135
VDE Schraubendreher Satz



XX	Ausführung	SW
3 x		PH0 · PH1 · PH2
4 x		0.5x3 · 0.8x4 · 1x5.5 · 1.2x6.5 mm

XX	Ausführung	SW
1 x		0.5x3 mm

V5013-L, EAN 4047728050128
Weichschaum-Einlage · leer



V5015, EAN 4047728050159

VDE Zangen Satz

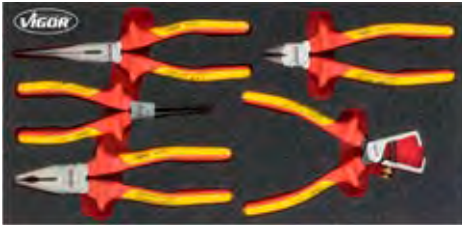

XX	Ausführung	SW
1 x		180 mm
1 x		160 mm
1 x		160 mm

XX	Ausführung	SW
1 x		200 mm
1 x		160 mm



V5015-L, EAN 4047728050142

Weichschaum-Einlage · leer



V4999N, EAN 4047728078726

Zangen Satz

NEU

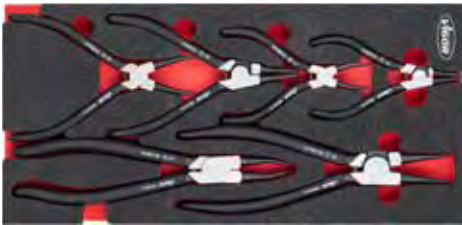

XX	Ausführung	SW
3 x		140 · 180 · 230 mm

XX	Ausführung	SW
3 x		140 · 180 · 230 mm



V4999N-L, EAN 4047728077989

Weichschaum-Einlage · leer



V5603, EAN 4047728078917

Schlagschrauber
Schraubendreher-Einsatz Satz

NEU



XX	Ausführung	SW
8 x		5 · 6 · 8 · 10 · 12 · 14 · 17 · 19 mm
8 x		M5 · M6 · M8 · M10 · M12 · M14 · M16 · M18

XX	Ausführung	SW
8 x		T30 · T40 · T45 · T50 · T55 · T60 · T70 · T80



V5603-L, EAN 4047728078580

Weichschaum-Einlage · leer



V5633N, EAN 4047728078740

Zangen Satz

NEU



XX	Ausführung	SW
1 x		250 mm
1 x		200 mm

XX	Ausführung	SW
1 x		180 mm
1 x		160 mm



V5633N-L, EAN 4047728078009

Weichschaum-Einlage · leer



Weichschaum-Einlagen



V7520, EAN 4047728075824
Doppelsechskant-Steckschlüssel Satz



XX	■	Ausführung	SW
17 x	12.9 1/2		10 · 11 · 12 · 13 · 14 · 15 · 16 · 17 · 18 · 19 · 20 · 21 · 22 · 24 · 27 · 30 · 32 mm
10 x	10 3/8		10 · 11 · 12 · 13 · 14 · 15 · 16 · 17 · 18 · 19 mm

XX	■	Ausführung	SW
13 x	6.3 1/4		4 · 4.5 · 5 · 5.5 · 6 · 7 · 8 · 9 · 10 · 11 · 12 · 13 · 14 mm

V7520-L, EAN 4047728075800
Weichschaum-Einlage · leer

V5103, EAN 4047728051033
Steckschlüssel Satz



XX	■	Ausführung	SW
13 x	6.3 1/4		4 · 4.5 · 5 · 5.5 · 6 · 7 · 8 · 9 · 10 · 11 · 12 · 13 · 14 mm
6 x	6.3 1/4		3 · 4 · 5 · 6 · 7 · 8 mm
3 x	6.3 1/4		PH1 · PH2 · PH3
3 x	6.3 1/4		PZ1 · PZ2 · PZ3
3 x	6.3 1/4		0.8x4-1x5.5-1.2x7 mm
6 x	6.3 1/4		T10 · T15 · T20 · T25 · T30 · T40
1 x	-	6.3 1/4	150 mm
1 x	6.3 1/4	6.3 1/4	110 mm
1 x	6.3 1/4	6.3 1/4	40 mm
1 x	6.3 1/4	6.3 1/4	145 mm
1 x	6.3 1/4	6.3 1/4	50 mm
1 x	6.3 1/4	6.3 1/4	100 mm

XX	■	Ausführung	SW
18 x	12.9 1/2		10 · 11 · 12 · 13 · 14 · 15 · 16 · 17 · 18 · 19 · 20 · 21 · 22 · 23 · 24 · 27 · 30 · 32 mm
2 x	12.9 1/2		16 · 21 mm
1 x	-	12.9 1/2	250 mm
1 x	12.9 1/2	12.9 1/2	75 mm
1 x	12.9 1/2	12.9 1/2	125 mm
1 x	12.9 1/2	12.9 1/2	250 mm
4 x	-		1.3 · 2 · 45.5-51 mm mm
1 x	-	6.3 1/4	150 mm
1 x	-	12.9 1/2	250 mm
1 x	6.3 1/4	6.3 1/4	25 mm

V5103-L, EAN 4047728051040
Weichschaum-Einlage · leer

V5081, EAN 4047728050814
Schraubendreher Satz



XX	■	Ausführung	SW
9 x			T10 · T15 · T20 · T25 · T27 · T30 · T40 · T45 · T50
1 x			0.5x3 mm
9 x			1.5 · 2 · 2.5 · 3 · 4 · 5 · 6 · 8 · 10
6 x			0.6x3 · 0.8x4 · 1x5.5 · 1.2x6.5 · 1.6x8 · 1.6x10 mm

XX	■	Ausführung	SW
4 x			PH0 · PH1 · PH2 · PH3
1 x			1x5.5 mm
1 x			PH2

V5081-L, EAN 4047728050821
Weichschaum-Einlage · leer



V5085, EAN 4047728**050852**
Hammer- und Meißel Satz



XX	Ausführung	SW
1 x		20 mm
1 x		32 mm
1 x		18 mm
1 x		Ø 4 mm
1 x		6 mm

XX	Ausführung	SW
6 x		Ø 2 · 3 · 4 · 5 · 6 · 8 mm
1 x		1500 g
1 x		800 g
1 x		Ø 32 mm

V5085-L, EAN 4047728**050869**
Weichschaum-Einlage · leer



V5087, EAN 4047728**050876**
VDE Werkzeug Satz



XX	Ausführung	SW
1 x		0.5x3 mm
1 x		160 mm
1 x		160 mm
1 x		180 mm

XX	Ausführung	SW
1 x		200 mm
1 x		160 mm
4 x		0.5x3 · 0.8x4 · 1x5.5 · 1.2x6.5mm
3 x		PH0 · PH1 · PH2

V5087-L, EAN 4047728**050883**
Weichschaum-Einlage · leer



Weichschaum-Einlagen



V4188, EAN 4047728041881
Steckschlüssel-Werkzeug Satz



XX	■		Ausführung	SW
5 x	6.3 1/4	+		R5 · R6 · R7 · R8 · R9
3 x	6.3 1/4	+		T5 · T6 · T7
3 x	6.3 1/4	○		M5 · M6 · M8
9 x	6.3 1/4	+		T7H · T10H · T15H · T20H · T25H · T27H · T30H · T40H · T45H
6 x	8 9/16	+		T40 · T45 · T50 · T55 · T60 · T70
5 x	8 9/16	○		7 · 8 · 10 · 12 · 14 mm
2 x	8 9/16	+		PH3 · PH4
2 x	8 9/16	+		PZ3 · PZ4
3 x	8 9/16	○		1.6x8 · 1.6x10 · 2x12 mm
6 x	8 9/16	+		T40H · T45H · T50H · T55H · T60H · T70H
4 x	-	○		1.3 · 2 · 45.5 · 51 mm
1 x	10 3/8	8 9/16		28 mm
1 x	12 1/2	8 9/16		37 mm
1 x	-	6.3 1/4		150 mm
1 x	6.3 1/4	6.3 1/4		110 mm
1 x	-	12 1/2		43.7 mm
4 x	6.3 1/4	○		3 · 4 · 5 · 6 mm
4 x	6.3 1/4	○		0.8x4 · 1x5.5 · 1.2x6.5 · 1.2x7 mm
3 x	6.3 1/4	+		PH0 · PH1 · PH2
3 x	6.3 1/4	+		PZ0 · PZ1 · PZ2
7 x	6.3 1/4	+		T9 · T10 · T15 · T20 · T25 · T27 · T30
7 x	6.3 1/4	+		T9H · T10H · T15H · T20H · T25H · T27H · T30H

XX	■		Ausführung	SW
6 x	10 3/8	+		E10 · E11 · E12 · E14 · E16 · E18
6 x	10 3/8	○		10 · 11 · 12 · 13 · 14 · 15 mm
10 x	10 3/8	○		10 · 11 · 12 · 13 · 14 · 15 · 16 · 17 · 18 · 19 mm
17 x	12 1/2	○		10 · 11 · 12 · 13 · 14 · 15 · 16 · 17 · 18 · 19 · 20 · 21 · 22 · 24 · 27 · 30 · 32 mm
5 x	12 1/2	○		16 · 17 · 18 · 19 · 22 mm
2 x	12 1/2	+		E20 · E24
13 x	6.3 1/4	○		4 · 4.5 · 5 · 5.5 · 6 · 7 · 8 · 9 · 10 · 11 · 12 · 13 · 14 mm
7 x	6.3 1/4	○		4 · 5 · 6 · 7 · 8 · 9 · 10 mm
5 x	6.3 1/4	+		E4 · E5 · E6 · E7 · E8
1 x	-	6.3 1/4		150 mm
1 x	-	10 3/8		198 mm
1 x	-	12 1/2		250 mm
1 x	6.3 1/4	6.3 1/4		40 mm
1 x	10 3/8	10 3/8		50 mm
1 x	12 1/2	12 1/2		75 mm
1 x	6.3 1/4	6.3 1/4		50 mm
1 x	6.3 1/4	6.3 1/4		100 mm
1 x	10 3/8	10 3/8		125 mm
1 x	12 1/2	12 1/2		125 mm
1 x	12 1/2	12 1/2		250 mm
1 x	10 3/8	○		18 mm
2 x	12 1/2	○		16 · 21 mm



V4130, EAN 4047728041300
Weichschaum-Einlage · leer



V5115, EAN 4047728051293

Steckschlüssel Satz



XX	■		Ausführung	SW
12 x	6.3 1/4	●		4 · 5 · 5.5 · 6 · 7 · 8 · 9 · 10 · 11 · 12 · 13 · 14 mm
1 x	6.3 1/4	6.3 1/4		40 mm
1 x	6.3 1/4	6.3 1/4		50 mm
1 x	6.3 1/4	6.3 1/4		100 mm
1 x	-	6.3 1/4		150 mm
1 x	-	6.3 1/4		150 mm
17 x	12.5 1/2	●		10 · 11 · 12 · 13 · 14 · 15 · 17 · 16 · 18 · 19 · 20 · 21 · 22 · 24 · 27 · 30 · 32 mm
2 x	12.5 1/2	●		16 · 21 mm
1 x	12.5 1/2	12.5 1/2		75 mm
1 x	12.5 1/2	12.5 1/2		125 mm

XX	■		Ausführung	SW
1 x	12.5 1/2	12.5 1/2		250 mm
1 x	-	12.5 1/2		250 mm
1 x	-	12.5 1/2		43.7 mm
1 x	6.3 1/4	6.3 1/4		25 mm
1 x	6.3 1/4	10 3/8		26 mm
1 x	10 3/8	6.3 1/4		27 mm
1 x	10 3/8	12.5 1/2		36 mm
1 x	12.5 1/2	10 3/8		36 mm
1 x	12.5 1/2	20 3/4		46 mm
1 x	20 3/4	12.5 1/2		50 mm
5 x	6.3 1/4			32 x

V5115-L, EAN 4047728051811

Weichschaum-Einlage · leer



V2837, EAN 4047728028370

Steckschlüsseinsatz Satz



XX	■		Ausführung	SW
7 x	6.3 1/4	●		E4 · E5 · E6 · E7 · E8 · E10 · E11
12 x	10 3/8	●		E4 · E5 · E6 · E7 · E8 · E10 · E11 · E12 · E14 · E16 · E18 · E20
9 x	12.5 1/2	●		E10 · E11 · E12 · E14 · E16 · E18 · E20 · E22 · E24
8 x	12.5 1/2	●		M5 · M6 · M8 · M9 · M10 · M12 · M14 · M16

XX	■		Ausführung	SW
9 x	12.5 1/2	○		5 · 6 · 7 · 8 · 10 · 12 · 14 · 17 · 19 mm
9 x	12.5 1/2	●		M5 · M6 · M7 · M8 · M9 · M10 · M12 · M13 · M14
10 x	12.5 1/2	●		T20 · T25 · T27 · T30 · T40 · T45 · T50 · T55 · T60 · T70

V2838, EAN 4047728028387

Weichschaum-Einlage · leer



V5109, EAN 4047728051095
Steckschlüssel Satz



XX	■		Ausführung	SW
16 x	20 3/4	●		19 · 21 · 22 · 23 · 24 · 26 · 27 · 28 · 30 · 32 · 34 · 36 · 38 · 41 · 46 · 50 mm
1 x	-	20 3/4		500 mm

XX	■		Ausführung	SW
1 x	20 3/4	20 3/4		200 mm
1 x	20 3/4	20 3/4		100 mm
1 x	20 3/4	20 3/4		400 mm
1 x	-	20 3/4		450 mm



V5109-L, EAN 4047728051101
Weichschaum-Einlage · leer



V4753, EAN 4047728047531
Schraubendreher-Einsatz Satz



XX	■		Ausführung	SW
9 x	125 1/2	⊕		M5 · M6 · M7 · M8 · M9 · M10 · M12 · M13 · M14
9 x	125 1/2	⊕		M5 · M6 · M7 · M8 · M9 · M10 · M12 · M13 · M14
10 x	125 1/2	⊕		T20 · T25 · T27 · T30 · T40 · T45 · T50 · T55 · T60 · T70
10 x	125 1/2	⊕		T20 · T25 · T27 · T30 · T40 · T45 · T50 · T55 · T60 · T70

XX	■		Ausführung	SW
7 x	125 1/2	○		M5 · M6 · M8 · M9 · M10 · M12 · M14
8 x	125 1/2	○		M5 · M6 · M8 · M9 · M10 · M14 · M16 · M12
8 x	125 1/2	○		5 · 6 · 7 · 8 · 10 · 11 · 12 · 13 mm
9 x	125 1/2	○		5 · 6 · 7 · 8 · 10 · 12 · 14 · 17 · 19 mm

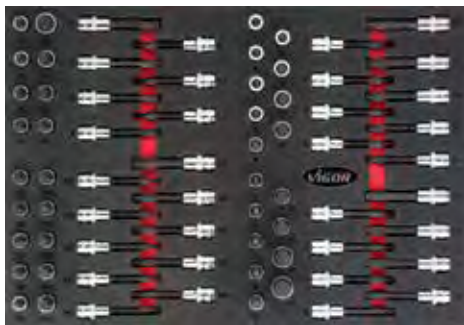

V4752, EAN 4047728047524
Weichschaum-Einlage · leer



V4727, EAN 4047728047272
Schraubendreher-Einsatz Satz



XX	■		Ausführung	SW
10 x	125 1/2	⊕		T20 · T25 · T27 · T30 · T40 · T45 · T50 · T55 · T60 · T70
10 x	125 1/2	⊕		T20 · T25 · T27 · T30 · T40 · T45 · T50 · T55 · T60 · T70
6 x	125 1/2	⊕		T40 · T45 · T50 · T55 · T60 · T70
6 x	125 1/2	⊕		T40 · T45 · T50 · T55 · T60 · T70

XX	■		Ausführung	SW
9 x	125 1/2	○		5 · 6 · 7 · 8 · 10 · 12 · 14 · 17 · 19 mm
8 x	125 1/2	○		5 · 6 · 7 · 8 · 10 · 11 · 12 · 13 mm
7 x	125 1/2	○		5 · 6 · 7 · 8 · 10 · 12 · 14 mm
6 x	125 1/2	○		5 · 6 · 7 · 8 · 10 · 12 mm



V4726, EAN 4047728047265
Weichschaum-Einlage · leer



V4729, EAN 4047728**047296**
Schraubendreher-Einsatz Satz

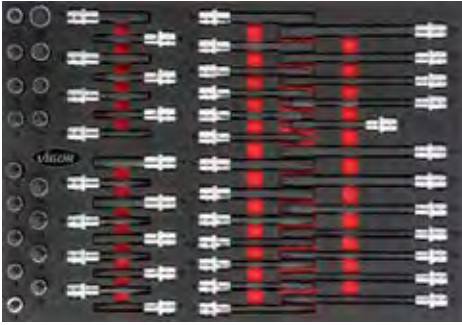

XX		Ausführung	SW
8 x			M5 · M6 · M8 · M9 · M10 · M12 · M14 · M16
7 x			M5 · M6 · M8 · M9 · M10 · M12 · M14
7 x			M5 · M6 · M8 · M9 · M10 · M12 · M14
4 x			M8 · M10 · M12 · M14

XX		Ausführung	SW
9 x			M5 · M6 · M7 · M8 · M9 · M10 · M12 · M13 · M14
9 x			M5 · M6 · M7 · M8 · M9 · M10 · M12 · M13 · M14
7 x			M8 · M9 · M10 · M10.3 · M12 · M13 · M14
7 x			M8 · M9 · M10 · M10.3 · M12 · M13 · M14

V4728, EAN 4047728**047289**
Weichschaum-Einlage · leer

V6726, EAN 4047728**067515**
Doppel-Maul-, Doppel-Ring- und Ring-Maulschlüssel Satz

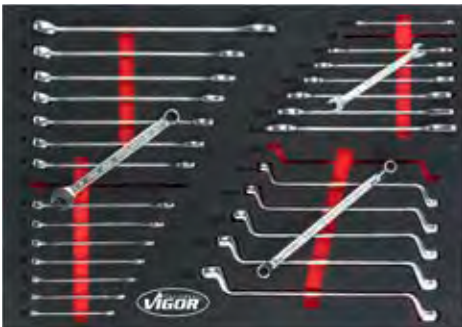

XX		Ausführung	SW
8 x			6x7 · 8x9 · 10x11 · 12x13 · 14x15 · 16x17 · 18x19 · 20x22 mm
15 x			6 · 7 · 8 · 9 · 10 · 11 · 12 · 13 · 14 · 15 · 16 · 17 · 18 · 19 · 22 mm

XX		Ausführung	SW
6 x			10x11 · 12x13 · 14x15 · 16x17 · 18x19 · 20x22 mm

V6726-L, EAN 4047728**067263**
Weichschaum-Einlage · leer

V6643, EAN 4047728**067430**
Doppel-Ringschlüssel-, Doppel-Maulschlüssel-, Ring-Maulschlüssel Satz



XX		Ausführung	SW
9 x			6x7 · 8x9 · 10x11 · 12x13 · 14x15 · 16x17 · 18x19 · 20x22 · 21x23 mm
17 x			6 · 7 · 8 · 9 · 10 · 11 · 12 · 13 · 14 · 15 · 16 · 17 · 18 · 19 · 22 · 24 · 27 mm

XX		Ausführung	SW
10 x			6x7 · 8x9 · 10x11 · 12x13 · 14x15 · 16x17 · 18x19 · 20x22 · 21x23 · 24x27 mm

V6643-L, EAN 4047728**066433**
Weichschaum-Einlage · leer

Weichschaum-Einlagen



V6724, EAN 4047728067492

Doppel-Maulschlüssel-, Ring-Maulschlüssel-,
Ratschen Ring-Maulschlüssel Satz



XX	Ausführung	SW
12 x		8 · 9 · 10 · 11 · 12 · 13 · 14 · 15 · 16 · 17 · 18 · 19 mm
12 x		6 x 7 · 8 x 9 · 10 x 11 · 12 x 13 · 14 x 15 · 16 x 17 · 18 x 19 · 20 x 22 · 21 x 23 · 24 x 27 · 25 x 28 · 30 x 32 mm

XX	Ausführung	SW
21 x		6 · 7 · 8 · 9 · 10 · 11 · 12 · 13 · 14 · 15 · 16 · 17 · 18 · 19 · 20 · 21 · 22 · 24 · 27 · 30 · 32 mm



V6724-L, EAN 4047728067249

Weichschaum-Einlage · leer



V4230, EAN 4047728042307

Schraubendreher Satz



XX	Ausführung	SW
6 x		6 · 7 · 8 · 10 · 12 · 13 mm
6 x		0.6 x 3 · 0.8 x 4 · 1 x 5.5 · 1.2 x 6.5 · 1.6 x 8 · 1.6 x 10 mm
4 x		PH0 · PH1 · PH2 · PH3
1 x		1 x 5.5 mm
1 x		PH2

XX	Ausführung	SW
7 x		T10 · T15 · T20 · T25 · T27 · T30 · T40
1 x		0.5 x 3 mm
2 x		PH1 · PH2
4 x		0.6 x 3.5 · 1 x 4.5 · 1 x 5.5 · 1.2 x 6.5 mm



V4231, EAN 4047728042314

Weichschaum-Einlage · leer



V5175, EAN 4047728051750

T-Griff Schraubendreher und
Winkelschraubendreher Satz



XX	Ausführung	SW
9 x		1.5 · 2 · 2.5 · 3 · 4 · 5 · 6 · 8 · 10
9 x		T10 · T15 · T20 · T25 · T27 · T30 · T40 · T45 · T50

XX	Ausführung	SW
8 x		2 · 2.5 · 3 · 4 · 5 · 6 · 8 · 10 mm
8 x		T9 · T10 · T15 · T20 · T25 · T27 · T30 · T40



V5175-L, EAN 4047728051767

Weichschaum-Einlage · leer



V6821, EAN 4047728068222

Steckschlüssel Satz

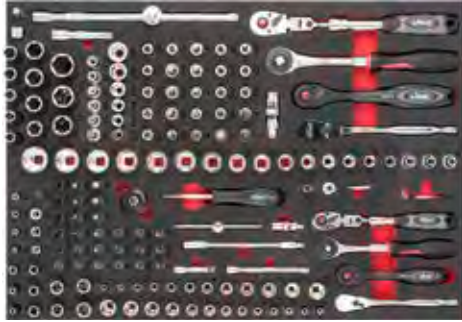

XX	■		Ausführung	SW	XX	■		Ausführung	SW
12 x	10	3/8		E4 · E5 · E6 · E7 · E8 · E10 · E11 · E12 · E14 · E16 · E18 · E20	13 x	6.3	1/4		4 · 4.5 · 5 · 5.5 · 6 · 7 · 8 · 9 · 10 · 11 · 12 · 13 · 14 mm
18 x	10	3/8		6 · 7 · 8 · 9 · 10 · 11 · 12 · 13 · 14 · 15 · 16 · 17 · 18 · 19 · 20 · 21 · 22 · 24 mm	6 x	6.3	1/4		T10 · T15 · T20 · T25 · T30 · T40
10 x	10	3/8		8 · 9 · 10 · 11 · 12 · 13 · 14 · 15 · 17 · 19 mm	7 x	6.3	1/4		T9H · T10H · T15H · T20H · T25H · T27H · T30H
2 x	10	3/8		16 · 21 mm	6 x	6.3	1/4		3 · 4 · 5 · 6 · 7 · 8 mm
9 x	10	3/8		T15 · T20 · T25 · T27 · T30 · T40 · T45 · T50 · T55	3 x	6.3	1/4		PH1 · PH2 · PH3
7 x	10	3/8		3 · 4 · 5 · 6 · 7 · 8 · 10 mm	3 x	6.3	1/4		PZ1 · PZ2 · PZ3
3 x	10	3/8		PH1 · PH2 · PH3	3 x	10	3/8		0.8x5.5-1x7-1.2x8 mm
3 x	10	3/8		PZ1 · PZ2 · PZ3	1 x	10	3/8		250 mm
3 x	10	3/8		0.8x5.5-1x7-1.2x8 mm	1 x	10	3/8		50 mm
1 x	10	3/8		250 mm	1 x	10	3/8		75 mm
1 x	10	3/8		50 mm	1 x	12.5	1/2		36 mm
1 x	10	3/8		75 mm	1 x	6.3	1/4		27 mm
1 x	10	3/8		36 mm	1 x	12.5	1/2		40 mm
1 x	10	3/8		27 mm	7 x	6.3	1/4		E4 · E5 · E6 · E7 · E8 · E10 · E11
1 x	12.5	1/2		40 mm	11 x	6.3	1/4		4 · 5 · 6 · 7 · 8 · 9 · 10 · 11 · 12 · 13 · 14 mm
7 x	6.3	1/4		E4 · E5 · E6 · E7 · E8 · E10 · E11	10 x	6.3	1/4		4 · 5 · 6 · 7 · 8 · 9 · 10 · 11 · 12 · 13 mm
11 x	6.3	1/4		4 · 5 · 6 · 7 · 8 · 9 · 10 · 11 · 12 · 13 · 14 mm					
10 x	6.3	1/4		4 · 5 · 6 · 7 · 8 · 9 · 10 · 11 · 12 · 13 mm					

V6821-L, EAN 4047728068055

Weichschaum-Einlage · leer



V6822, EAN 4047728068284

Steckschlüssel Satz



XX	■		Ausführung	SW	XX	■		Ausführung	SW	
6 x	12.5	1/2		E14 · E16 · E18 · E20 · E22 · E24	1 x	12.5	1/2		36 mm	
18 x	12.5	1/2		10 · 11 · 12 · 13 · 14 · 15 · 16 · 17 · 18 · 19 · 20 · 21 · 22 · 23 · 24 · 27 · 30 · 32 mm	1 x	12.5	1/2		75 mm	
11 x	12.5	1/2		10 · 11 · 12 · 13 · 14 · 15 · 16 · 17 · 18 · 19 · 22 mm	1 x	12.5	1/2		125 mm	
2 x	12.5	1/2		16 · 21 mm	1 x	12.5	1/2		250 mm	
17 x	12.5	1/2		10 · 11 · 12 · 13 · 14 · 15 · 16 · 17 · 18 · 19 · 20 · 21 · 22 · 24 · 27 · 30 · 32 mm	1 x	12.5	1/2		46 mm	
					1 x	20	3/4		50 mm	
					1 x	-	12.5	1/2		288 mm
					1 x	-	12.5	1/2		250 mm
					1 x	-	12.5	1/2		250 mm
					1 x	-	12.5	1/2		250 mm
					1 x	-	12.5	1/2		-

V6822-L, EAN 4047728068062

Weichschaum-Einlage · leer



Weichschaum-Einlagen



V6809, EAN 4047728068307
Schraubendreher-Einsatz Satz



XX			Ausführung	SW
10 x				T20 · T25 · T27 · T30 · T40 · T45 · T50 · T55 · T60 · T70
10 x				T20 · T25 · T27 · T30 · T40 · T45 · T50 · T55 · T60 · T70
6 x				T40 · T45 · T50 · T55 · T60 · T70
6 x				T40 · T45 · T50 · T55 · T60 · T70

XX			Ausführung	SW
9 x				5 · 6 · 7 · 8 · 10 · 12 · 14 · 17 · 19 mm
8 x				5 · 6 · 7 · 8 · 10 · 11 · 12 · 13 mm
7 x				5 · 6 · 7 · 8 · 10 · 12 · 14 mm
6 x				5 · 6 · 7 · 8 · 10 · 12 mm

V6809-L, EAN 4047728068093
Weichschaum-Einlage · leer



V6810, EAN 4047728068413
Schraubendreher-Einsatz Satz



XX			Ausführung	SW
9 x				M5 · M6 · M7 · M8 · M9 · M10 · M12 · M13 · M14
9 x				M5 · M6 · M7 · M8 · M9 · M10 · M12 · M13 · M14
7 x				M8 · M9 · M10 · M10.3 · M12 · M13 · M14
7 x				M8 · M9 · M10 · M10.3 · M12 · M13 · M14

XX			Ausführung	SW
8 x				M5 · M6 · M8 · M9 · M10 · M12 · M14 · M16
7 x				M5 · M6 · M8 · M9 · M10 · M12 · M14
7 x				M5 · M6 · M8 · M10 · M12 · M14 · M9
4 x				M8 · M10 · M12 · M14

V6810-L, EAN 4047728068109
Weichschaum-Einlage · leer



V6807, EAN 4047728068277
Ratschen Ring-Maulschlüssel Satz



XX			Ausführung	SW
18 x				8 · 9 · 10 · 11 · 12 · 13 · 14 · 15 · 16 · 17 · 18 · 19 · 21 · 22 · 24 · 27 · 30 · 32 mm

XX			Ausführung	SW
22 x				6 · 7 · 8 · 9 · 10 · 11 · 12 · 14 · 13 · 15 · 16 · 17 · 18 · 19 · 20 · 21 · 22 · 24 · 27 · 30 · 32 · 36 mm

V6807-L, EAN 4047728068079
Weichschaum-Einlage · leer



V6808, EAN 4047728068291

Doppel-Ring- und Maulschlüssel Satz

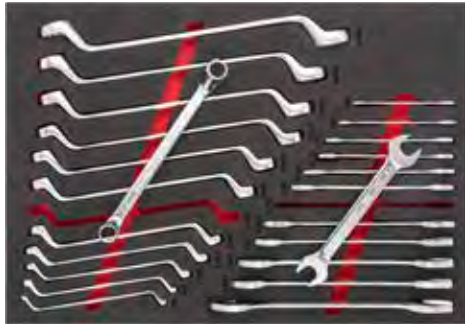

XX	Ausführung	SW
12 x		6x7 · 8x9 · 10x11 · 12x13 · 14x15 · 16x17 · 18x19 · 20x22 · 21x23 · 24x27 · 25x28-30x32mm

XX	Ausführung	SW
12 x		6x7 · 8x9 · 10x11 · 12x13 · 14x15 · 16x17 · 18x19 · 20x22 · 21x23 · 24x27 · 25x28-30x32mm

V6808-L, EAN 4047728068086

Weichschaum-Einlage · leer



V6813, EAN 4047728068444

Schraubendreher Satz

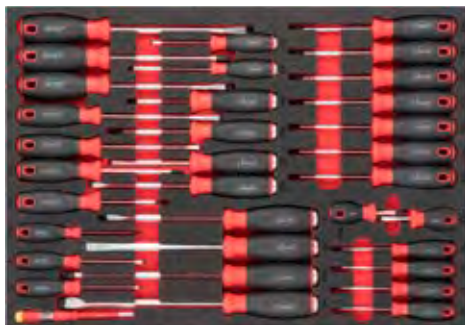

XX	Ausführung	SW
6 x		0,6 x 3 · 0,8 x 4 · 1 x 5,5 · 1,2 x 6,5 · 1,6 x 8 · 1,6 x 10 mm
4 x		PH0 · PH1 · PH2 · PH3
1 x		1 x 5,5 mm
1 x		PH2

XX	Ausführung	SW
7 x		0,6 x 3,5 · 1 x 4,5 · 1 x 5,5 · 1,2 x 6,5 · 1,6 x 8 · 1,6 x 10 · 2 x 12 mm
3 x		PH1 · PH2 · PH3
11 x		T6 · T7 · T8 · T9 · T10 · T15 · T20 · T25 · T27 · T30 · T40
1 x		0,5 x 3 mm

V6813-L, EAN 4047728068130

Weichschaum-Einlage · leer



V6814, EAN 4047728068451

Schraubendreher- und Bit Satz



XX	Ausführung	SW
4 x		1,6 · 2 · 2,4 · 3
2 x		PH0 · PH00
1 x		260 mm
1 x		260 mm
1 x		260 mm
1 x		260 mm
1 x		260 mm
1 x		260 mm
1 x		130 mm
1 x		130 mm
1 x		130 mm
1 x		130 mm

XX	Ausführung	SW
5 x		32 x
5 x		22 x
1 x		200 mm
3 x		6 · 7 · 8 mm
9 x		T10 · T15 · T20 · T25 · T27 · T30 · T40 · T45 · T50
9 x		1,5 · 2 · 2,5 · 3 · 4 · 5 · 6 · 8 · 10
6 x		6 · 7 · 8 · 10 · 12 · 13 mm

V6814-L, EAN 4047728068147

Weichschaum-Einlage · leer



Weichschaum-Einlagen



V6817, EAN 4047728068499

Hammer-, Meißel- und Splinttreiber Satz



XX	Ausführung	SW
1 x		800 g
1 x		1500 g
1 x		∅ 32 mm
1 x		645 mm
1 x		10 x
1 x		210 mm
1 x		10 x
1 x		90 mm

XX	Ausführung	SW
1 x		-
6 x		∅ 3 · 4 · 5 · 6 · 8 · 2 mm
1 x		6 mm
1 x		18 mm
1 x		∅ 4 mm
2 x		190 · 170 mm
2 x		∅ 4 · 40 mm
4 x		10 · 16 · 20 · 29 mm
7 x		∅ 2 · 3 · 4 · 5 · 6 · 7 · 8 mm

V6817-L, EAN 4047728068178

Weichschaum-Einlage · leer



V6818, EAN 4047728068482

Schaber- und Lösehebel Satz



XX	Ausführung	SW
1 x		165 mm
1 x		5 x
1 x		490 mm
1 x		16 x

XX	Ausführung	SW
1 x		22 mm
1 x		10 x
1 x		4 x
1 x		40 mm

V6818-L, EAN 4047728068185

Weichschaum-Einlage · leer



V6811, EAN 4047728068420

Schlagschrauber Steckschlüsseleinsatz Satz



XX	■	■	Ausführung	SW
1 x	6.3	1/4	6.3 1/4	-
1 x	10	3/8	10 3/8	-
1 x	12.5	1/2	12.5 1/2	-
5 x	12.5	1/2		15 · 17 · 19 · 21 · 22 mm
1 x	12.5	1/2		17 mm
1 x	12.5	1/2		19 mm
13 x	12.5	1/2		10 · 11 · 12 · 13 · 14 · 15 · 16 · 17 · 18 · 19 · 21 · 22 · 24 mm
15 x	12.5	1/2		21 · 22 · 24 · 27 · 30 · 32 · 10 · 11 · 12 · 13 · 14 · 15 · 16 · 17 · 19 mm

XX	■	■	Ausführung	SW
13 x	12.5	1/2		10 · 11 · 12 · 13 · 14 · 15 · 16 · 17 · 18 · 19 · 21 · 22 · 24 mm
8 x	12.5	1/2		T30 · T40 · T45 · T50 · T55 · T60 · T70 · T80
8 x	12.5	1/2		M5 · M6 · M8 · M10 · M12 · M14 · M16 · M18
8 x	12.5	1/2		5 · 6 · 8 · 10 · 12 · 14 · 17 · 19 mm
1 x	12.5	1/2		78 mm
4 x	20	3/4		24 · 30 · 32 · 36 mm

V6811-L, EAN 4047728068116

Weichschaum-Einlage · leer



V6812, EAN 4047728068437
Räder / Reifen Werkzeug-Satz



XX	Ausführung	SW
1 x	-	-
1 x	-	-
1 x	-	9 mm
1 x	-	500 mm
1 x	-	-

XX	Ausführung	SW
1 x	-	128 mm
1 x	-	4 x
1 x	12x 1/2	118 mm
1 x	-	250 mm
1 x	12x 1/2	540 mm

V6812-L, EAN 4047728068123
Weichschaum-Einlage · leer

V5111N, EAN 4047728078733
Schraubendreher · Zangen Satz

NEU



XX	Ausführung	SW
1 x	-	300 g
1 x	-	160 mm
6 x	-	∅ 2 · 3 · 4 · 5 · 6 · 8 mm
1 x	-	∅ 4 mm
1 x	-	0.05 – 1.00 mm

XX	Ausführung	SW
2 x	-	0.6 x 3 – 1.2 x 6.5 · PH0 – PH2
1 x	-	250 mm
1 x	-	200 mm
9 x	-	T10 · T15 · T20 · T25 · T27 · T30 · T40 · T45 · T50
9 x	-	1.5 · 2 · 2.5 · 3 · 4 · 5 · 6 · 8 · 10

V5111N-L, EAN 4047728077996
Weichschaum-Einlage · leer

V5634N, EAN 4047728078757
Hammer Zangen Schraubendreher Satz

NEU



XX	Ausführung	SW
1 x	-	-
1 x	-	250 mm
1 x	-	300 g
1 x	-	∅ 32 mm
1 x	-	160 mm

XX	Ausführung	SW
1 x	-	200 mm
1 x	-	∅ 4 mm
6 x	-	∅ 2 · 3 · 4 · 5 · 6 · 8 mm
1 x	-	0.05 – 1.00 mm
2 x	-	0.6 x 3 – 1.2 x 6.5 · PH0 – PH2

V5634N-L, EAN 4047728078016
Weichschaum-Einlage · leer

Weichschaum-Einlagen



V5636N, EAN 4047728078764
Zangen · Hammer Satz

NEU

25

2 K

L



	Ausführung	SW
1 x		40 mm
1 x		340 mm
1 x		200 mm
1 x		180 mm
1 x		160 mm
3 x		230 · 180 · 140 mm

	Ausführung	SW
3 x		230 · 140 · 180 mm
1 x		∅ 40 mm
1 x		800 g
1 x		22 mm
1 x		10 x
1 x		250 mm

V5636N-L, EAN 4047728078030
Weichschaum-Einlage · leer



V5637N, EAN 4047728078771
Zangen, Hammer ·
Meißel Satz

NEU

40

2 K

L



	Ausführung	SW
1 x		0.05 - 1.00 mm
1 x		180 mm
1 x		180 mm
1 x		180 mm
1 x		180 mm
1 x		180 mm
1 x		∅ 4 mm
6 x		∅ 2 · 3 · 4 · 5 · 6 · 8 mm
1 x		18 mm

	Ausführung	SW
1 x		6 mm
1 x		180 mm
1 x		160 mm
1 x		∅ 32 mm
1 x		300 g
1 x		22 mm
1 x		250 mm
1 x		-

V5637N-L, EAN 4047728078047
Weichschaum-Einlage · leer



V6815N, EAN 4047728078795
Zangen Satz

NEU

34

2 K

L



	Ausführung	SW
1 x		115 mm
1 x		180 mm
1 x		160 mm
1 x		200 mm
1 x		250 mm
1 x		290 mm

	Ausführung	SW
1 x		300 mm
1 x		340 mm
1 x		340 mm
1 x		335 mm
1 x		345 mm
1 x		345 mm

V6815N-L, EAN 4047728078061
Weichschaum-Einlage · leer



V6816N, EAN 4047728078801

Zangen Satz

NEU

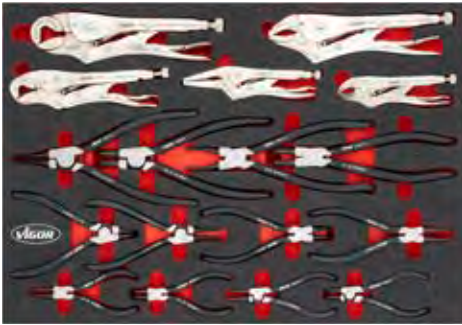

xx	Ausführung	SW
1 x		150 mm
1 x		250 mm
1 x		125 mm
1 x		11 - 19 mm
1 x		16 - 27 mm

xx	Ausführung	SW
3 x		140 · 180 · 230 mm
3 x		140 · 180 · 230 mm
3 x		140 · 180 · 230 mm
3 x		140 · 180 · 230 mm

V6816N-L, EAN 4047728078078

Weichschaum-Einlage · leer



Weichschaum-Einlagen



V4586, EAN 4047728**045865**

Steckschlüssel-Werkzeug Satz für Series XL



XX	■	⊕	Ausführung	SW
5 x	6.3 1/4	⊕	R5 · R6 · R7 · R8 · R9	
3 x	6.3 1/4	⊕	T5 · T6 · T7	
3 x	6.3 1/4	⊖	M5 · M6 · M8	
9 x	6.3 1/4	⊕	T7H · T10H · T15H · T20H · T25H · T27H · T30H · T40H · T45H	
6 x	8 5/8	⊕	T40 · T45 · T50 · T55 · T60 · T70	
5 x	8 5/8	⊖	7 · 8 · 10 · 12 · 14 mm	
2 x	8 5/8	⊕	PH3 · PH4	
2 x	8 5/8	⊕	PZ3 · PZ4	
3 x	8 5/8	⊖	1.6x8-1.6x10-2x12 mm	
6 x	8 5/8	⊕	T40H · T45H · T50H · T55H · T60H · T70H	
2 x	-	⊖	1.3 · 2 · 45.5-51 mm	
1 x	10 3/8	8 5/8	28 mm	
1 x	6.3 1/4	6.3 1/4	25 mm	
1 x	12.5 1/2	8 5/8	37 mm	
1 x	6.3 1/4	6.3 1/4	25 mm	
1 x	6.3 1/4	6.3 1/4	110 mm	
1 x	-	6.3 1/4	150 mm	
1 x	-	12.5 1/2	43.7 mm	
8 x	12.5 1/2	⊕	T20 · T25 · T27 · T30 · T40 · T45 · T50 · T55	
8 x	12.5 1/2	⊕	T27 · T30 · T40 · T45 · T50 · T55 · T60 · T70	
8 x	12.5 1/2	⊖	M5 · M6 · M8 · M9 · M10 · M14 · M16 · M12	
7 x	12.5 1/2	⊖	M5 · M6 · M8 · M9 · M10 · M12 · M14	
8 x	12.5 1/2	⊖	5 · 6 · 7 · 8 · 10 · 12 · 14 · 17 mm	
8 x	12.5 1/2	⊖	5 · 6 · 7 · 8 · 10 · 11 · 12 · 13 mm	
7 x	6.3 1/4	⊕	T9 · T10 · T15 · T20 · T25 · T27 · T30	
4 x	6.3 1/4	⊖	3 · 4 · 5 · 6 mm	

XX	■	⊕	Ausführung	SW
3 x	6.3 1/4	⊕	PH0 · PH1 · PH2	
3 x	6.3 1/4	⊕	PZ0 · PZ1 · PZ2	
4 x	6.3 1/4	⊖	0.8x4 · 1x5.5 · 1.2x6.5 · 1.2x7 mm	
7 x	6.3 1/4	⊕	T9H · T10H · T15H · T20H · T25H · T27H · T30H	
10 x	10 3/8	⊖	10 · 11 · 12 · 13 · 14 · 15 · 16 · 17 · 18 · 19 mm	
6 x	10 3/8	⊖	10 · 11 · 12 · 13 · 14 · 15 mm	
6 x	10 3/8	⊕	E10 · E11 · E12 · E14 · E16 · E18	
17 x	12.5 1/2	⊖	10 · 11 · 12 · 13 · 14 · 15 · 16 · 17 · 18 · 19 · 20 · 21 · 22 · 24 · 27 · 30 · 32 mm	
5 x	12.5 1/2	⊖	16 · 17 · 18 · 19 · 22 mm	
2 x	12.5 1/2	⊕	E20 · E24	
13 x	6.3 1/4	⊖	4 · 4.5 · 5 · 5.5 · 6 · 7 · 8 · 9 · 10 · 11 · 12 · 13 · 14 mm	
7 x	6.3 1/4	⊖	4 · 5 · 6 · 7 · 8 · 9 · 10 mm	
5 x	6.3 1/4	⊕	E4 · E5 · E6 · E7 · E8	
1 x	-	6.3 1/4	150 mm	
1 x	-	10 3/8	198 mm	
1 x	-	12.5 1/2	250 mm	
1 x	6.3 1/4	6.3 1/4	40 mm	
1 x	10 3/8	10 3/8	50 mm	
1 x	12.5 1/2	12.5 1/2	75 mm	
1 x	6.3 1/4	6.3 1/4	50 mm	
1 x	6.3 1/4	6.3 1/4	100 mm	
1 x	10 3/8	10 3/8	125 mm	
1 x	12.5 1/2	12.5 1/2	125 mm	
1 x	12.5 1/2	12.5 1/2	250 mm	
1 x	10 3/8	⊖	18 mm	
2 x	12.5 1/2	⊖	16 · 21 mm	

V4521, EAN 4047728**045216**

Weichschaum-Einlage · leer



V6650, EAN 4047728067454

Ring-Maul-, Doppelring-,
Doppelmaulschlüssel Satz für Series XL



XX	Ausführung	SW
12 x		6x7 · 8x9 · 10x11 · 12x13 · 14x15 · 16x17 · 18x19 · 20x22 · 21x23 · 24x27 · 25x28-30x32mm
12 x		6x7 · 8x9 · 10x11 · 12x13 · 14x15 · 16x17 · 18x19 · 20x22 · 21x23 · 24x27 · 25x28-30x32mm

XX	Ausführung	SW
12 x		8 · 9 · 10 · 11 · 12 · 13 · 14 · 15 · 16 · 17 · 18 · 19 mm
22 x		6 · 7 · 8 · 9 · 10 · 11 · 12 · 13 · 14 · 15 · 16 · 17 · 18 · 19 · 20 · 21 · 22 · 24 · 27 · 30 · 32 · 36 mm

V6650-L, EAN 4047728066501

Weichschaum-Einlage · leer



V5170, EAN 4047728051712

Schraubendreher Satz für Series XL



XX	Ausführung	SW
4 x		1.6 · 2 · 2.4 · 3
2 x		PH0 · PH00
11 x		T6 · T7 · T8 · T9 · T10 · T15 · T20 · T25 · T27 · T30 · T40
4 x		PH0 · PH1 · PH2 · PH3
3 x		PH1 · PH2 · PH3
1 x		PH2
5 x		0.6x3 · 0.8x4-1x5.5-1.6x8- 1.6x10 mm

XX	Ausführung	SW
4 x		0.6x3.5 · 1x4.5 · 1x5.5 · 1.2x6.5mm
1 x		1x5.5 mm
9 x		T10 · T15 · T20 · T25 · T27 · T30 · T40 · T45 · T50
9 x		1.5 · 2 · 2.5 · 3 · 4 · 5 · 6 · 8 · 10
6 x		6 · 7 · 8 · 10 · 12 · 13 mm
1 x		0.5x3 mm

V5170-L, EAN 4047728051729

Weichschaum-Einlage · leer



V5638N, EAN 4047728078788

Zangen · Hammer ·
Meißel Satz

NEU



XX	Ausführung	SW
1 x		1000 g
1 x		∅ 32 mm
1 x		22 mm
6 x		∅ 2 · 3 · 4 · 5 · 6 · 8 mm
1 x		∅ 4 mm
1 x		18 mm
1 x		6 mm
1 x		40 mm
1 x		10 x
1 x		150 mm
1 x		335 mm

XX	Ausführung	SW
1 x		340 mm
1 x		1500 g
1 x		165 mm
1 x		160 mm
1 x		180 mm
1 x		200 mm
1 x		250 mm
3 x		140 · 180 · 230 mm
3 x		140 · 180 · 230 mm

V5638N-L, EAN 4047728078054

Weichschaum-Einlage · leer



Weichschaum-Einlagen



V6015, EAN 4047728074667

Schlagschrauber · Steckschlüssel Satz

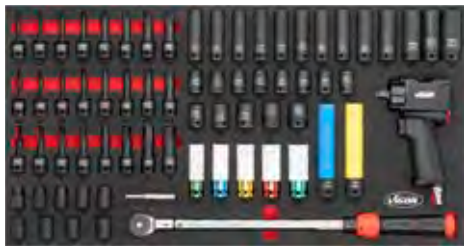

XX			Ausführung	SW
1 x	12.9	1/2		19 mm
1 x	12.9	1/2		17 mm
1 x	-	12.9 1/2		540 mm
1 x	-	12.9 1/2		118 mm
13 x	12.9	1/2		10 · 11 · 12 · 13 · 14 · 15 · 16 · 17 · 18 · 19 · 21 · 22 · 24 mm
13 x	12.9	1/2		10 · 11 · 12 · 13 · 14 · 15 · 16 · 17 · 18 · 19 · 21 · 22 · 24 mm

XX			Ausführung	SW
9 x	12.9	1/2		10 · 11 · 12 · 13 · 14 · 15 · 16 · 17 · 19 mm
5 x	12.9	1/2		15 · 17 · 19 · 21 · 22 mm
8 x	12.9	1/2		5 · 6 · 8 · 10 · 12 · 14 · 17 · 19 mm
8 x	12.9	1/2		M5 · M6 · M8 · M10 · M12 · M14 · M16 · M18
8 x	12.9	1/2		T30 · T40 · T45 · T50 · T55 · T60 · T70 · T80

V6015-L, EAN 4047728074056

Weichschaum-Einlage · leer



V7015N, EAN 4047728078818

Zangen · Schaber Satz



XX	Ausführung	SW
1 x		800 g
1 x		300 mm
1 x		335 mm
1 x		340 mm
1 x		10 x
1 x		90 mm
1 x		165 mm
1 x		290 mm

XX	Ausführung	SW
1 x		16 x
7 x		Ø 2 · 3 · 4 · 5 · 6 · 7 · 8 mm
2 x		Ø 4 · 40 mm
4 x		10 · 16 · 20 · 29 mm
2 x		170 · 190 mm
1 x		180 mm
1 x		200 mm
1 x		250 mm

V7015N-L, EAN 4047728078085

Weichschaum-Einlage · leer



V5009, EAN 4047728050098
2-Komponenten Weichschaum-Einlage · mit Leerfach

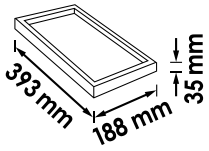

V4631, EAN 4047728046312
2-Komponenten Weichschaum-Einlage · ohne Ausfräsung

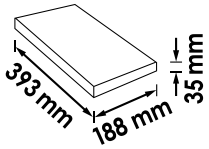

V5018, EAN 4047728050180
2-Komponenten Weichschaum-Einlage · mit Leerfach

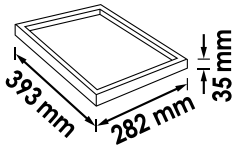

V4632, EAN 4047728046329
2-Komponenten Weichschaum-Einlage · ohne Ausfräsung

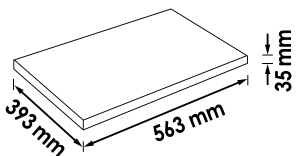

V4633, EAN 4047728064347
2-Komponenten Weichschaum-Einlage · ohne Ausfräsung

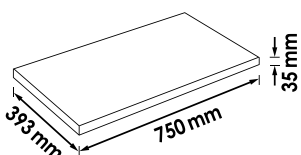





Handwerkzeuge

Steckschlüssel Systeme	118–173
Universal Werkzeugkoffer	174–175
Schraubenschlüssel	176–183
Schraubendreher und Bits	184–195
Zangen	196–208
VDE Werkzeuge	209–212
Schlag-, Schaber- und Lösewerkzeuge	213–220
Diverse Handwerkzeuge	220–221
Schneiden und Sägen	221–227



V5202, EAN 4047728**068987**

Steckschlüssel Satz · superflach

- Flaches Einsatz-Profil – Direktes Ansetzen an der Mutter / Verschraubung
- Robuste Vollstahl-Umschaltknarre
- Rechts- und Linksbetrieb
- Ergonomischer Griff
- Steckschlüssel-Einsätze ohne Einlauffase
- Superkurze Einsätze ermöglichen Arbeiten an sehr engen Stellen
- Durchgängige Steckschlüssel ermöglichen Arbeiten an Stehbolzen
- Steckschlüssel-Einsätze mit Außensechskant SW 11 mm zur Befügung mit Ring- oder Maulschlüssel

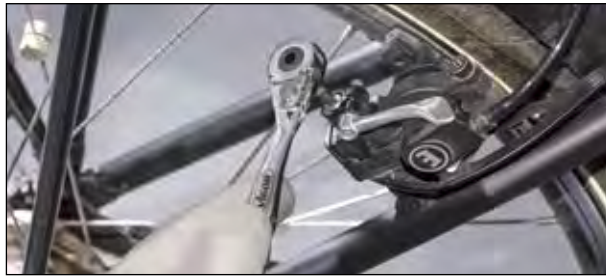
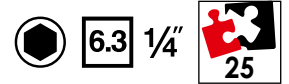

Einzelteilaufistung ab Seite 122

XX	■	●	Ausführung	SW
3 x	6.3 1/4"	⊖		0.8 x 4 · 1 x 5 · 1 x 6 mm
2 x	6.3 1/4"	⊕		PH1 · PH2
5 x	6.3 1/4"	⊗		T15 · T20 · T25 · T27 · T30
1 x	-	6.3 1/4"		-
1 x	6.3 1/4"	6.3 1/4"		-
13 x	6.3 1/4"	●		4 · 4.5 · 5 · 5.5 · 6 · 7 · 8 · 9 · 10 · 11 · 12 · 13 · 14 mm



Inklusive Bit-Halter und Bits



V3734N, EAN 4047728**056427**

Steckschlüssel Satz

- Für Handbetätigung



Einzelteilaufistung ab Seite 120

XX	■	●	Ausführung	SW
2 x	6.3 1/4"	⊕		PH1 · PH2
2 x	6.3 1/4"	⊕		PZ1 · PZ2
4 x	6.3 1/4"	⊗		T15 · T20 · T25 · T30
1 x	6.3 1/4"	6.3 1/4"		25 mm
12 x	6.3 1/4"	●		4 · 4.5 · 5 · 5.5 · 6 · 7 · 8 · 9 · 10 · 11 · 12 · 13 mm
1 x	-	6.3 1/4"		150 mm
1 x	6.3 1/4"	6.3 1/4"		100 mm

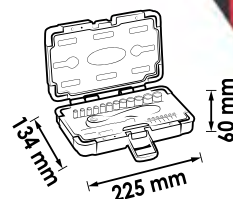

V2414N, EAN 4047728056434

Steckschlüssel Satz

• Für Handbetätigung



Einzelteilauflistung ab Seite 120

XX	■	●	Ausführung	SW
13 x	6.3 1/4	●		4 · 4.5 · 5 · 5.5 · 6 · 7 · 8 · 9 · 10 · 11 · 12 · 13 · 14 mm
3 x	6.3 1/4	●		0.8x4 · 1x5.5 · 1.2x7 mm
6 x	6.3 1/4	○		3 · 4 · 5 · 6 · 7 · 8 mm
3 x	6.3 1/4	+		PH1 · PH2 · PH3
3 x	6.3 1/4	+		PZ1 · PZ2 · PZ3
6 x	6.3 1/4	+		T10 · T15 · T20 · T25 · T30 · T40
2 x	-	○		1.3 · 2 mm
2 x	-	-	-	45.5 · 51 mm
1 x	10 3/8	6.3 1/4		27 mm
1 x	6.3 1/4	6.3 1/4		110 mm
1 x	6.3 1/4	6.3 1/4		50 mm
1 x	6.3 1/4	6.3 1/4		100 mm
1 x	6.3 1/4	6.3 1/4		145 mm
1 x	6.3 1/4	6.3 1/4		40 mm
1 x	-	6.3 1/4		150 mm
1 x	-	6.3 1/4		150 mm

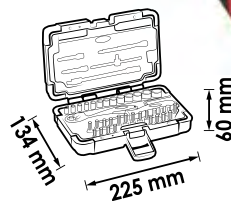

V7514/13, EAN 4047728074063

Doppelsechskant-Steckschlüssel Satz

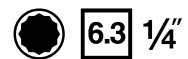

Einzelteilauflistung ab Seite 123

XX	■	●	Ausführung	SW
13 x	6.3 1/4	●		4 · 4.5 · 5 · 5.5 · 6 · 7 · 8 · 9 · 10 · 11 · 12 · 13 · 14 mm



V1897, EAN 4047728**018975**

Multiprofil Steckschlüsseleinsatz Satz

• Für Handbetätigung

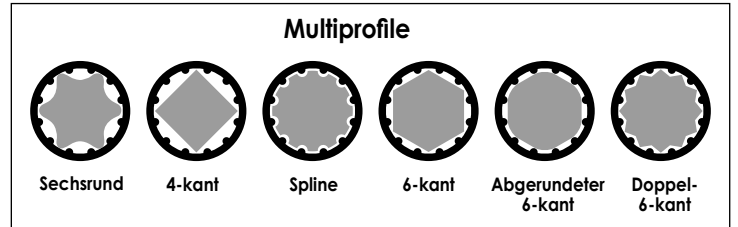
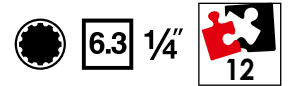

Alle Einsätze für 6 Profile geeignet

Einzelteilaufistung ab Seite 124

XX	■	●	Ausführung	SW
12 x	6.3 1/4"	●		4 · 5 · 5.5 · 6 · 7 · 8 · 9 · 10 · 11 · 12 · 13 · 14 mm

V6014, EAN 4047728**055833**

Feinzahn-Umschaltknarre

- Gekröpfte Ausführung
- Kunststoffummantel
- Auslöseknopf
- 72 Zähne
- 5° Betätigungswinkel
- Für Handbetätigung

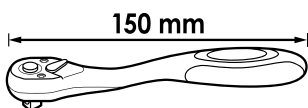

6.3 1/4"

V6014-REP, EAN 4047728**056519**

Reparatur Satz

- Reparatur Satz für Feinzahn-Umschaltknarre V6014



V6614, EAN 4047728**066440**

Teleskop Gelenk-Umschaltknarre

- Ausziehbar von 175 – 225 mm
- 180° schwenkbarer Kopf inklusive Arretierung
- Auslöseknopf
- 72 Zähne
- 5° Betätigungswinkel
- Für Handbetätigung

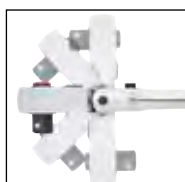
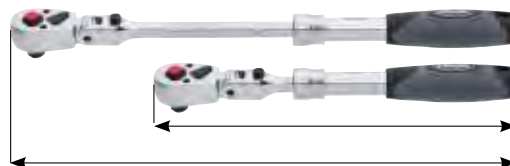

5 Positionen arretierbar

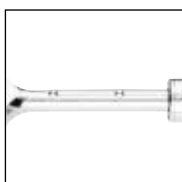

Auf verschiedene Fixierungspunkte einstellbar

V6614-REP, EAN 4047728**067980**

Reparatur Satz

- Reparatur Satz für Teleskop Gelenk-Umschaltknarre V6614



V4944-S, EAN 4047728055345

Feinzahn-Umschaltknarre · Standard

- Robust und servicefreundlich
- Geschlossenes System
- Leicht zu reinigen
- 72 Zähne
- 5° Betätigungswinkel
- Für Handbetätigung

6.3 1/4"

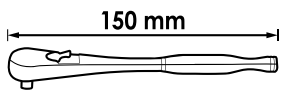

6.3 1/4"

V4944-REP, EAN 4047728049474

Reparatur Satz

- Reparatur Satz für Feinzahn-Umschaltknarren V4944 · V4944-S · V4944-XS



V4944-XS, EAN 4047728069557

Feinzahn-Umschaltknarre · extrakurze Ausführung

- Robust und servicefreundlich
- Geschlossenes System
- Leicht zu reinigen
- 72 Zähne
- 5° Betätigungswinkel
- Für Handbetätigung

6.3 1/4"

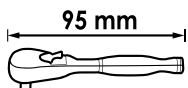

6.3 1/4"



V5436, EAN 4047728054362

360° Drehgriff-Umschaltknarre

- Einsatz in beengten Bereichen
- Durchsteckvierkant für Rechts- / Linksbetrieb
- Standard-Betätigung durch Feststellen möglich
- Betätigung nur rechtslaufend
- 72 Zähne
- 5° Betätigungswinkel
- Für Handbetätigung

6.3 1/4"



Lösen und Anziehen von Verschraubungen nur im arretierten Modus



Antriebsmechanismus im 360° Drehgriff

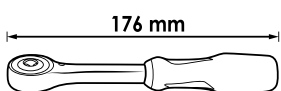

6.3 1/4"



V2941, EAN 4047728029414

Fingerratsche

- $\frac{1}{4}$ " $\frac{1}{4}$ " Fingerratsche, einzeln, für Bits
- 72 Zähne
- 5° Betätigungswinkel
- Für Handbetätigung

6.3 $\frac{1}{4}$ " $\frac{1}{4}$ "

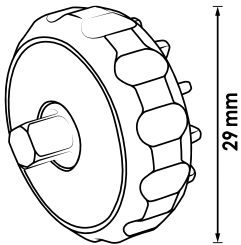

V5202-1, EAN 4047728069366

Umschaltknarre

- Flaches Einsatz-Profil – Direktes Ansetzen an der Mutter / Verschraubung
- Robuste Vollstahl-Umschaltknarre
- Rechts- und Linksbetrieb
- Ergonomischer Griff

6.3 $\frac{1}{4}$ "

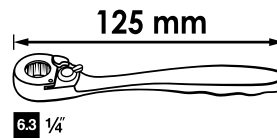

V2458N, EAN 4047728058179

Steckgriff

6.3 $\frac{1}{4}$ "



V2453N, EAN 4047728058124

Gleitgriff

6.3 $\frac{1}{4}$ " $\frac{1}{4}$ "



Sechskant Steckschlüsseleinsatz

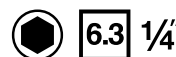

VIGOR No.	SW	L mm	EAN 4047728+
V2413N	4 mm	25	057738
V2415N	4.5 mm	25	057745
V2416N	5 mm	25	057752
V2417N	5.5 mm	25	057769
V2418N	6 mm	25	057776
V2419N	7 mm	25	057783
V2420N	8 mm	25	057790

VIGOR No.	SW	L mm	EAN 4047728+
V2421N	9 mm	25	057806
V2422N	10 mm	25	057813
V2423N	11 mm	25	057820
V2424N	12 mm	25	057837
V2425N	13 mm	25	057844
V2426N	14 mm	25	057851

Doppelsechskant Steckschlüsseleinsatz

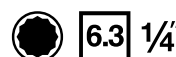

VIGOR No.	SW	L mm	EAN 4047728+
V7514-4	4 mm	25	074070
V7514-4.5	4.5 mm	25	074087
V7514-5	5 mm	25	074094
V7514-5.5	5.5 mm	25	074100
V7514-6	6 mm	25	074117
V7514-7	7 mm	25	074124
V7514-8	8 mm	25	074131

VIGOR No.	SW	L mm	EAN 4047728+
V7514-9	9 mm	25	074148
V7514-10	10 mm	25	074155
V7514-11	11 mm	25	074162
V7514-12	12 mm	25	074179
V7514-13	13 mm	25	074186
V7514-14	14 mm	25	074193

Sechskant Steckschlüsseleinsatz · lang

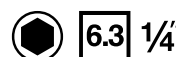

VIGOR No.	SW	L mm	EAN 4047728+
V2533N	4 mm	50	058193
V2534N	5 mm	50	058209
V2535N	6 mm	50	058216
V2536N	7 mm	50	058223
V2537N	8 mm	50	058230

VIGOR No.	SW	L mm	EAN 4047728+
V2538N	9 mm	50	058247
V2539N	10 mm	50	058254
V2699N	11 mm	50	058735
V2700N	12 mm	50	058742
V2701N	13 mm	50	058759

Sechskant Steckschlüsseleinsatz · superflach

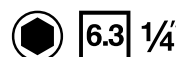

VIGOR No.	SW	EAN 4047728+
V5202-4	4 mm	069380
V5202-4.5	4.5 mm	069397
V5202-5	5 mm	069403
V5202-5.5	5.5 mm	069410
V5202-6	6 mm	069427
V5202-7	7 mm	069434
V5202-8	8 mm	069441

VIGOR No.	SW	EAN 4047728+
V5202-9	9 mm	069458
V5202-10	10 mm	069465
V5202-11	11 mm	069472
V5202-12	12 mm	069489
V5202-13	13 mm	069496
V5202-14	14 mm	069502

T Steckschlüsseleinsatz

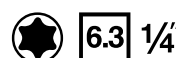

VIGOR No.	SW	L mm	EAN 4047728+
V2185	E4	24.8	021852
V2186	E5	24.8	021869
V2187	E6	24.8	021876
V2188	E7	24.8	021883
V2189	E8	24.8	021890
V2722	E10	24.8	027229
V2723	E11	24.8	027236

Multiprofil Steckschlüsseinsatz



VIGOR No.	SW	mm	EAN 4047728+
V1976	4 mm	25	019767
V1977	5 mm	25	019774
V1979	6 mm	25	019798
V1980	7 mm	25	019804
V1981	8 mm	25	019811
V1982	9 mm	25	019828

VIGOR No.	SW	mm	EAN 4047728+
V1983	10 mm	25	019835
V1984	11 mm	25	019842
V1985	12 mm	25	019859
V1986	13 mm	25	019866
V1987	14 mm	25	019873

T Schraubendreher-Einsatz



VIGOR No.	SW	mm	EAN 4047728+
V2595N	T9	38	058599
V2442N	T10	38	058018
V2443N	T15	38	058025
V2444N	T20	38	058032

VIGOR No.	SW	mm	EAN 4047728+
V2445N	T25	38	058049
V2130N	T27	38	057042
V2446N	T30	38	058056
V2447N	T40	38	058063

T-Plus Schraubendreher-Einsatz

NEU



VIGOR No.	SW	EAN 4047728+
V7037-IP8	T8+	078276
V7037-IP10	T10+	078283
V7037-IP15	T15+	078290
V7037-IP20	T20+	078306
V7037-IP25	T25+	078313
V7037-IP27	T27+	078320
V7037-IP30	T30+	078337

T Schraubendreher-Einsatz



VIGOR No.	SW	mm	EAN 4047728+
V2596N	T9H	38	058605
V2136	T10H	37	021364
V2138	T15H	37	021388
V2139	T20H	37	021395
V2140	T25H	37	021401
V2141	T27H	37	021418
V2142	T30H	37	021425

T-Plus Schraubendreher-Einsatz

NEU



VIGOR No.	SW	EAN 4047728+
V7037-IPR8	T8+H	078399
V7037-IPR10	T10+H	078405
V7037-IPR15	T15+H	078412
V7037-IPR20	T20+H	078429
V7037-IPR25	T25+H	078436
V7037-IPR27	T27+H	078443
V7037-IPR30	T30+H	078450

Schraubendreher-Einsatz

6.3 1/4"



VIGOR No.	SW	mm	EAN 4047728+
V2593N	PH0	38	058575
V2436N	PH1	38	057950
V2437N	PH2	38	057967
V2438N	PH3	38	057974

Schraubendreher-Einsatz

6.3 1/4"



VIGOR No.	SW	mm	EAN 4047728+
V2594N	PZ0	38	058582
V2439N	PZ1	38	057981
V2440N	PZ2	38	057998
V2441N	PZ3	38	058001

Schraubendreher-Einsatz

6.3 1/4"



VIGOR No.	SW	mm	EAN 4047728+
V2427N	0.8x4 mm	38	057868
V2428N	1x5.5 mm	38	057875
V2597N	1.2x6.5 mm	38	058612
V2429N	1.2x7 mm	38	057882

Innensechskant Schraubendreher-Einsatz Satz

6.3 1/4"



VIGOR No.	SW	mm	EAN 4047728+
V2430N	3 mm	38	057899
V2431N	4 mm	38	057905
V2432N	5 mm	38	057912
V2433N	6 mm	38	057929
V2434N	7 mm	38	057936
V2435N	8 mm	38	057943

Universalgelenk

6.3 1/4" 6.3 1/4"



VIGOR No.	mm	EAN 4047728+
V2454N	40	058131



Flexible Verlängerung

6.3 1/4" 6.3 1/4"



VIGOR No.	mm	EAN 4047728+
V2457N	145	058162

Schwenkbare Verlängerung

- Betätigung von Schraubverbindungen auf engem Raum und Umgehen von Störkanten
- Kugelförmiger, konischer Außenvierkant

6.3 1/4" 6.3 1/4"



VIGOR No.	mm	EAN 4047728+
V4311	36	043113
V4312	75	043120
V4313	250	043137

Verlängerung

6.3 1/4" 6.3 1/4"



VIGOR No.	mm	EAN 4047728+
V2455N	50	058148
V2456N	100	058155

Adapter



10 3/8" 6.3 1/4"

VIGOR No.	mm	EAN 4047728+
V2014	26	020145

Adapter



6.3 1/4" 6.3 1/4"

VIGOR No.	mm	EAN 4047728+
V2452N	25	058117

Bit Adapter



6.3 1/4" 6.3 1/4"

VIGOR No.	mm	EAN 4047728+
V3651N	25	058872

Bit Adapter

- Flaches Einsatz-Profil – Direktes Ansetzen an der Mutter / Verschraubung
- Antrieb wahlweise Außensechskant 11 mm oder Innensechskant 6,3 mm (1/4 Zoll)
- Abtrieb Innensechskant 6,3 mm (1/4 Zoll) für Bits
- Für Handbetätigung



6.3 1/4" 6.3 1/4"

VIGOR No.	EAN 4047728+
V5202-2	069373



V6202, EAN 4047728062022

Steckschlüssel Satz · superflach

- Flaches Einsatz-Profil – Direktes Ansetzen an der Mutter / Verschraubung
- Robuste Vollstahl-Umschaltknarre
- Rechts- und Linksbetrieb
- Ergonomischer Griff
- Steckschlüssel-Einsätze ohne Einlauffase
- Superkurze Einsätze ermöglichen Arbeiten an sehr engen Stellen
- Steckschlüssel-Einsätze mit Außensechskant SW 17 mm zur Betätigung mit Ring- oder Maulschlüssel

Dein Problemlöser bei
flachen Verschraubungen
und engen Räumen

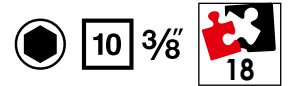

Ohne Einlauffase!
Für geringe
Schraubkopf-Höhen

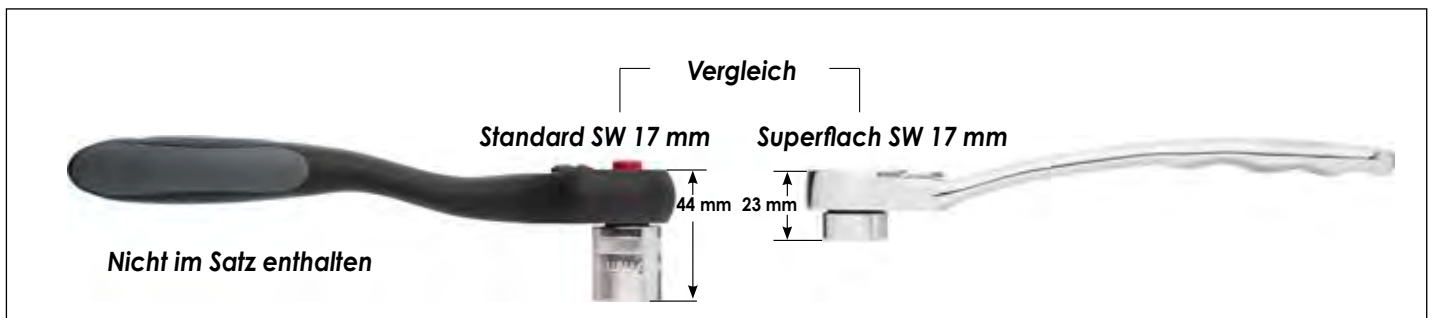

Einzelteilliste ab Seite 132

XX	■		Ausführung	SW
1 x	-	10 3/8		200 mm
1 x	17 mm	10 3/8		30 mm
1 x	10 3/8	10 3/8		60 mm
1 x	10 3/8	10 3/8		75 mm
1 x	10 3/8	10 3/8		150 mm
13 x	10 3/8			8 · 9 · 10 · 11 · 12 · 13 · 14 · 15 · 16 · 17 · 19 · 21 · 22 mm



V2305N, EAN 4047728056441

Steckschlüssel Satz

• Für Handbetätigung

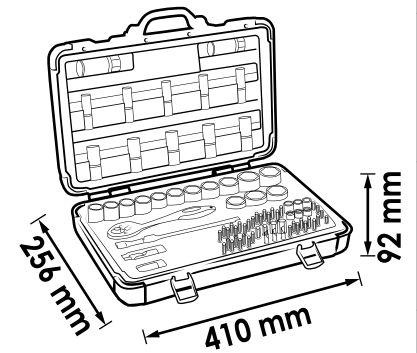

Einzelteilaufistung ab Seite 131

XX	■	■	Ausführung	SW
18 x	10 3/8	●		6 · 7 · 8 · 9 · 10 · 11 · 12 · 13 · 14 · 15 · 16 · 17 · 18 · 19 · 20 · 21 · 22 · 24 mm
10 x	10 3/8	●		8 · 9 · 10 · 11 · 12 · 13 · 14 · 15 · 17 · 19 mm
2 x	10 3/8	●		16 · 21 mm
7 x	10 3/8	○		3 · 4 · 5 · 6 · 7 · 8 · 10 mm
3 x	10 3/8	◐		0.8x5.5 · 1x7 · 1.2x8 mm
3 x	10 3/8	+		PH1 · PH2 · PH3
3 x	10 3/8	+		PZ1 · PZ2 · PZ3
9 x	10 3/8	⊕		T15 · T20 · T25 · T27 · T30 · T40 · T45 · T50 · T55
1 x	10 3/8	⊕		28 mm
1 x	12 3/8 1/2	10 3/8		40 mm
1 x	10 3/8	10 3/8		75 mm
1 x	10 3/8	10 3/8		250 mm
1 x	10 3/8	10 3/8		50 mm
1 x	-	10 3/8		198 mm

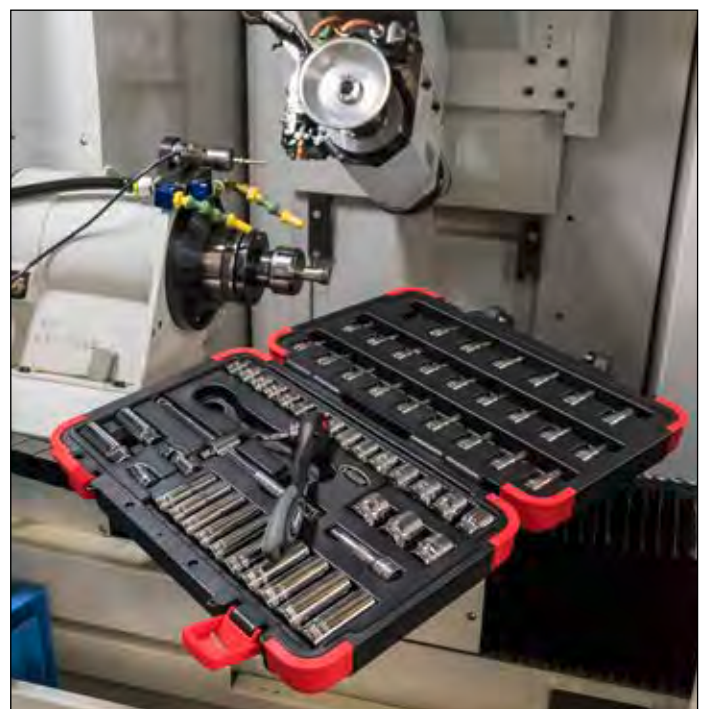

V7538/10, EAN 4047728074209

Doppelsechskant-Steckschlüssel Satz

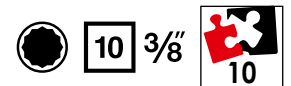

Einzelteilaufistung ab Seite 132

XX	■	○	Ausführung	SW
10 x	10 3/8	●		10 · 11 · 12 · 13 · 14 · 15 · 16 · 17 · 18 · 19 mm



V6017, EAN 4047728064361

T Schraubendreher-Einsatz Satz

- Klingen phosphatiert
- Chrom-Vanadium Stahl
- Rändelung
- Für Handbetätigung

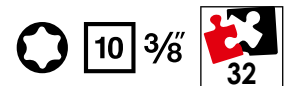

Einzelteilaufistung ab Seite 135

XX	■	○	Ausführung	SW
8 x	10 3/8	⊗		T20 · T25 · T27 · T30 · T40 · T45 · T50 · T55
2 x	10 3/8	⊗		T60 · T70
10 x	10 3/8	⊗		T20 · T25 · T27 · T30 · T40 · T45 · T50 · T55 · T60 · T70
6 x	10 3/8	⊗		T40 · T45 · T50 · T55 · T60 · T70
6 x	10 3/8	⊗		T40 · T45 · T50 · T55 · T60 · T70



V6018, EAN 4047728065894

Innenvielzahn Schraubendreher-Einsatz Satz (XZN)

- Klingen phosphatiert
- Chrom-Vanadium Stahl
- Rändelung
- Für Handbetätigung

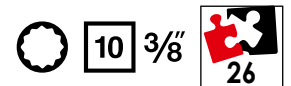

Einzelteilaufistung ab Seite 136

XX	■	○	Ausführung	SW
8 x	10 3/8	○		M5 · M6 · M8 · M9 · M10 · M12 · M14 · M16
7 x	10 3/8	○		M5 · M6 · M8 · M9 · M10 · M12 · M14
7 x	10 3/8	○		M5 · M6 · M8 · M9 · M10 · M12 · M14
4 x	10 3/8	○		M8 · M10 · M12 · M14



V6019, EAN 4047728065900

Innensechskant Schraubendreher-Einsatz Satz

- Klingen phosphatiert
- Chrom-Vanadium Stahl
- Rändelung
- Für Handbetätigung

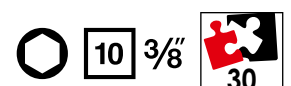

Einzelteilaufistung ab Seite 137

XX	■	○	Ausführung	SW
9 x	10 3/8	○		5 · 6 · 7 · 8 · 10 · 12 · 14 · 17 · 19 mm
8 x	10 3/8	○		5 · 6 · 7 · 8 · 10 · 11 · 12 · 13 mm
7 x	10 3/8	○		5 · 6 · 7 · 8 · 10 · 12 · 14 mm
6 x	10 3/8	○		5 · 6 · 7 · 8 · 10 · 12 mm



V6038, EAN 4047728**055840**

Feinzahn-Umschaltknarre

- Gekröpfte Ausführung
- Kunststoffummantel
- Auslöseknopf
- DIN 3122, ISO 3315
- 72 Zähne
- 5° Betätigungswinkel
- Für Handbetätigung

10 3/8"

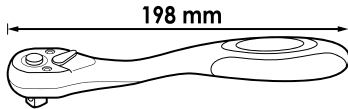

10 3/8"

V6038-REP, EAN 4047728**056526**

Reparatur Satz

- Reparatur Satz für Feinzahn-Umschaltknarre V6038 · V6638



V6638, EAN 4047728**066457**

Teleskop Gelenk-Umschaltknarre

- Ausziehbar von 250 – 350 mm
- 180° Schwenkbarer Kopf inklusive Arretierung
- Auslöseknopf
- 72 Zähne
- 5° Betätigungswinkel
- Für Handbetätigung

10 3/8"

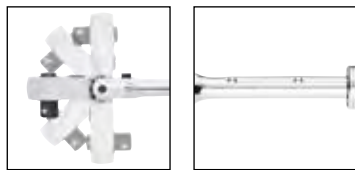

5 Positionen arretierbar

Auf verschiedene Fixierungspunkte einstellbar

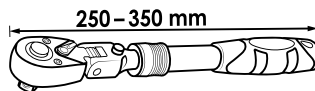

V4945-S, EAN 4047728**055352**

Feinzahn-Umschaltknarre · Standard

- Robust und servicefreundlich
- Geschlossenes System
- Leicht zu reinigen
- 72 Zähne
- 5° Betätigungswinkel
- Für Handbetätigung

10 3/8"

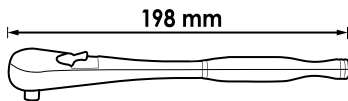

10 3/8"

V4945-REP, EAN 4047728**049481**

Reparatur Satz

- Reparatur Satz für Feinzahn-Umschaltknarren V4945 · V4945-S



V6008, EAN 4047728**060080**

360° Drehgriff-Umschaltknarre

- Einsatz in beengten Bereichen
- Durchsteckvierkant für Rechts- / Linksbetrieb
- Standard-Betätigung durch Feststellen möglich
- Betätigung nur rechtslaufend
- 72 Zähne
- 5° Betätigungswinkel
- Für Handbetätigung

10 3/8"



Lösen und Anziehen von Verschraubungen
nur im arretierten Modus



Antriebsmechanismus im 360° Drehgriff

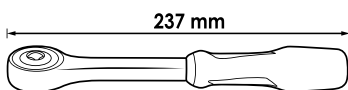

10 3/8"



V6202-1, EAN 4047728062640

10 3/8"

Umschaltknarre

- Robuste Vollstahl-Umschaltknarre
- Rechts- und Linksbetrieb
- Ergonomischer Griff



10 3/8"



Sechskant Steckschlüsseinsatz

10 3/8"



VIGOR No.	SW	L mm	EAN 4047728+
V2278N	6 mm	28	057219
V2277N	7 mm	28	056908
V2276N	8 mm	28	056892
V2275N	9 mm	28	056885
V2274N	10 mm	28	056878
V2273N	11 mm	28	056861
V2272N	12 mm	28	056854
V2271N	13 mm	28	056847
V2270N	14 mm	28	056830

VIGOR No.	SW	L mm	EAN 4047728+
V2269N	15 mm	28	057141
V2268N	16 mm	28	057134
V2267N	17 mm	30	057127
V2266N	18 mm	30	057110
V2265N	19 mm	30	057103
V2264N	20 mm	30	057097
V2263N	21 mm	30	057080
V2262N	22 mm	30	057073
V2261N	24 mm	30	057066

Doppelsechskant Steckschlüsseinsatz

10 3/8"



VIGOR No.	SW	L mm	EAN 4047728+
V7538-10	10 mm	28	074230
V7538-11	11 mm	28	074247
V7538-12	12 mm	28	074254
V7538-13	13 mm	28	074261
V7538-14	14 mm	28	074278
V7538-15	15 mm	28	074285
V7538-16	16 mm	28	074292
V7538-17	17 mm	30	074308
V7538-18	18 mm	30	074315
V7538-19	19 mm	30	074322

Sechskant Steckschlüsseinsatz · lang

10 3/8"



VIGOR No.	SW	L mm	EAN 4047728+
V2016N	8 mm	63	056922
V2017N	9 mm	63	056939
V2018N	10 mm	63	056946
V2019N	11 mm	63	056953
V2020N	12 mm	63	056960
V2311N	13 mm	63	057509
V2312N	14 mm	63	057516
V2313N	15 mm	63	057523
V2314N	17 mm	63	057530
V2315N	19 mm	63	057547

Sechskant Steckschlüsseinsatz · superflach

10 3/8"



VIGOR No.	SW	L mm	EAN 4047728+
V6202-8	8 mm	23	062053
V6202-9	9 mm	23	062077
V6202-10	10 mm	23	062091
V6202-11	11 mm	23	062107
V6202-12	12 mm	23	062510
V6202-13	13 mm	23	062534
V6202-14	14 mm	23	062572

VIGOR No.	SW	L mm	EAN 4047728+
V6202-15	15 mm	23	062589
V6202-16	16 mm	23	062596
V6202-17	17 mm	23	062602
V6202-19	19 mm	23	062220
V6202-21	21 mm	23	062619
V6202-22	22 mm	23	062626

T Steckschlüsseinsatz

10 3/8"



VIGOR No.	SW	L mm	EAN 4047728+
V2724	E4	28	027243
V2725	E5	28	027250
V2726	E6	28	027267
V2727	E7	28	027274
V2728	E8	28	027281
V2143	E10	28	021432

VIGOR No.	SW	L mm	EAN 4047728+
V2614N	E11	28	058674
V2144	E12	28	021449
V2145	E14	28	021456
V2146	E16	28	021463
V2615N	E18	28	058681
V2729	E20	28	027298

T-Plus Steckschlüsseinsatz

NEU 10 3/8"



VIGOR No.	SW	EAN 4047728+
V7920-EP4	E4+	078146
V7920-EP5	E5+	078153
V7920-EP6	E6+	078160
V7920-EP7	E7+	078177
V7920-EP8	E8+	078184
V7920-EP10	E10+	078191
V7920-EP12	E12+	078207

VIGOR No.	SW	EAN 4047728+
V7920-EP14	E14+	078214
V7920-EP16	E16+	078221
V7920-EP18	E18+	078238
V7920-EP20	E20+	078245
V7920-EP22	E22+	078252
V7920-EP24	E24+	078269

Zündkerzen-Einsatz

10 3/8"



VIGOR No.	SW	L mm	EAN 4047728+
V2119N	16 mm	66	057028
V2613N	18 mm	66	058667
V2120N	21 mm	66	057035



Schraubendreher-Einsatz

10 3/8"



VIGOR No.	SW	← L → mm	EAN 4047728+
V2288N	0.8x5.5 mm	49	057318
V2287N	1 x 7 mm	49	057301
V2286N	1.2x 8 mm	49	057295

Schraubendreher-Einsatz

10 3/8"



VIGOR No.	SW	← L → mm	EAN 4047728+
V2291N	PZ1	49	057349
V2290N	PZ2	49	057332
V2289N	PZ3	49	057325

Schraubendreher-Einsatz

10 3/8"



VIGOR No.	SW	← L → mm	EAN 4047728+
V2294N	PH1	49	057370
V2293N	PH2	49	057363
V2292N	PH3	49	057356

T Schraubendreher-Einsatz

10 3/8"



VIGOR No.	SW	← L → mm	EAN 4047728+
V2194	T45H	48	021944
V2195	T50H	48	021951

T Schraubendreher-Einsatz

10 3/8"



VIGOR No.	SW	L mm	EAN 4047728+
V6082	T60	49	060820
V6083	T70	49	060837

T Schraubendreher-Einsatz

10 3/8"



VIGOR No.	SW	L mm	EAN 4047728+
V2303N	T15	49	057493
V2302N	T20	49	057486
V2301N	T25	49	057479
V2300N	T27	49	057462
V2299N	T30	49	057455
V2298N	T40	49	057448
V2297N	T45	49	057431
V2149	T47	49	021494
V2296N	T50	49	057394
V2295N	T55	49	057387

T Schraubendreher-Einsatz

10 3/8"



VIGOR No.	SW	L mm	EAN 4047728+
V6084	T20	93	060844
V6085	T25	93	060851
V6086	T27	93	060868
V6087	T30	93	060875
V6088	T40	93	060882
V6089	T45	93	060899
V6090	T50	93	060905
V6091	T55	93	060912
V6092	T60	93	060929
V6093	T70	93	060936

T Schraubendreher-Einsatz

10 3/8"



VIGOR No.	SW	L mm	EAN 4047728+
V6094	T40	133	060943
V6095	T45	133	060950
V6096	T50	133	060967
V6097	T55	133	060974
V6098	T60	133	060981
V6099	T70	133	060998



T Schraubendreher-Einsatz



VIGOR No.	SW	← L → mm	EAN 4047728+
V6100	T40	193	061001
V6101	T45	193	061018
V6102	T50	193	061025
V6103	T55	193	061032
V6104	T60	193	061049
V6105	T70	193	061056

Innenvielzahn Schraubendreher-Einsatz (XZN)



VIGOR No.	SW	← L → mm	EAN 4047728+
V6106	M5	48	061063
V6107	M6	48	061070
V6108	M8	48	061087
V6109	M9	48	061094
V6110	M10	48	061100
V6111	M12	48	061117
V6112	M14	48	061124
V6113	M16	48	061131

Innenvielzahn Schraubendreher-Einsatz (XZN)



VIGOR No.	SW	← L → mm	EAN 4047728+
V6114	M5	93	061148
V6115	M6	93	061155
V6116	M8	93	061162
V6117	M9	93	061179
V6118	M10	93	061186
V6119	M12	93	061193
V6120	M14	93	061209

Innenvielzahn Schraubendreher-Einsatz (XZN)



VIGOR No.	SW	← L → mm	EAN 4047728+
V6121	M5	133	061216
V6122	M6	133	061223
V6123	M8	133	061230
V6124	M9	133	061247
V6125	M10	133	061254
V6126	M12	133	061261
V6127	M14	133	061278

Innenvielzahn Schraubendreher-Einsatz (XZN)



VIGOR No.	SW	← L → mm	EAN 4047728+
V6128	M8	193	061285
V6129	M10	193	061292
V6130	M12	193	061308
V6131	M14	193	061315

Innensechskant Schraubendreher-Einsatz



VIGOR No.	SW	← L → mm	EAN 4047728+
V2285N	3 mm	49	057288
V2284N	4 mm	49	057271
V2283N	5 mm	49	057264
V2282N	6 mm	49	057257
V2281N	7 mm	49	057240
V2280N	8 mm	49	057233
V2279N	10 mm	49	057226
V6137	12 mm	49	061377
V6138	14 mm	49	061384
V6139	17 mm	49	061391
V6140	19 mm	49	061407

Innensechskant Schraubendreher-Einsatz



VIGOR No.	SW	← L → mm	EAN 4047728+
V6141	5 mm	93	061414
V6142	6 mm	93	061421
V6143	7 mm	93	061438
V6144	8 mm	93	061445
V6145	10 mm	93	061452
V6146	11 mm	93	061469
V6147	12 mm	93	061476
V6148	13 mm	93	061483

Innensechskant Schraubendreher-Einsatz



VIGOR No.	SW	← L → mm	EAN 4047728+
V6149	5 mm	133	061490
V6194	6 mm	133	062466
V6151	7 mm	133	061513
V6152	8 mm	133	061520
V6153	10 mm	133	061537
V6154	12 mm	133	061544
V6155	14 mm	133	061551



Innensechskant Schraubendreher-Einsatz

10 3/8



VIGOR No.	SW	← L → mm	EAN 4047728+
V6156	5 mm	193	061568
V6157	6 mm	193	061575
V6158	7 mm	193	061582
V6159	8 mm	193	061599
V6160	10 mm	193	061605
V6161	12 mm	193	061612

Universalgelenk

10 3/8 10 3/8



VIGOR No.	← L → mm	EAN 4047728+
V2118N	50	057011

Universalgelenk

10 3/8 10 3/8



VIGOR No.	← L → mm	EAN 4047728+
V6202-3	60	062664

Verlängerung

10 3/8 10 3/8



VIGOR No.	← L → mm	EAN 4047728+
V2115N	75	056984
V2616N	125	058698
V2117N	250	057004

Schwenkbare Verlängerung

- Betätigung von Schraubverbindungen auf engem Raum und Umgehen von Störkanten
- Kugelförmiger, konischer Außenvierkant
- Schwenkwinkel nach jeder Seite 8°

10 3/8" 10 3/8"



VIGOR No.	mm	EAN 4047728+
V4314	36	043144
V4315	75	043151
V4316	250	043168

Verlängerung

10 3/8" 10 3/8"



VIGOR No.	mm	EAN 4047728+
V6202-4	75	062671
V6202-5	150	062688

Schiebestück / Adapter

10 3/8" 12⁵ 1/2"



VIGOR No.	mm	EAN 4047728+
V2116N	40	056991

Bit Adapter

8 5/16" 10 3/8"



VIGOR No.	mm	EAN 4047728+
V2114N	28	056977



Adapter

6.3 1/4 10 3/8



VIGOR No.	mm	EAN 4047728+
V2071	27	020718

Adapter

12.5 1/2 10 3/8



VIGOR No.	mm	EAN 4047728+
V2108	36	021081

Bit Adapter

10 3/8 8 5/16



VIGOR No.	mm	EAN 4047728+
V3652N	30	058889

Vierkant Adapter

10 3/8



17 mm



VIGOR No.	mm	EAN 4047728+
V6202-2	30	062657

V7202, EAN 4047728**068888**

Steckschlüssel Satz · superflach

- Flaches Einsatz-Profil – Direktes Ansetzen an der Mutter / Verschraubung
- Robuste Vollstahl-Umschaltknarre
- Rechts- und Linksbetrieb
- Ergonomischer Griff
- Steckschlüssel-Einsätze ohne Einlauffase
- Superkurze Einsätze ermöglichen Arbeiten an sehr engen Stellen
- Durchgängige Steckschlüsseinsätze ermöglichen Arbeiten an Stehbolzen
- Steckschlüssel-Einsätze mit Außensechskant SW 22 mm zur Befügung mit Ring-, oder Maulschlüssel



12⁵ 1/2"



Einzelteilaufistung ab Seite 151

XX	■		Ausführung	SW
1 x	-	12 ⁵ 1/2"		-
1 x	22 mm	12 ⁵ 1/2"		-
1 x	12 ⁵ 1/2"	12 ⁵ 1/2"		-
1 x	12 ⁵ 1/2"	12 ⁵ 1/2"		125 mm
1 x	12 ⁵ 1/2"	12 ⁵ 1/2"		250 mm
19 x	12 ⁵ 1/2"	●		8 · 9 · 10 · 11 · 12 · 13 · 14 · 15 · 16 · 17 · 18 · 19 · 20 · 21 · 22 · 24 · 27 · 30 · 32 mm



V2460N, EAN 4047728**056458**

Steckschlüssel Satz

- Für Handbetätigung

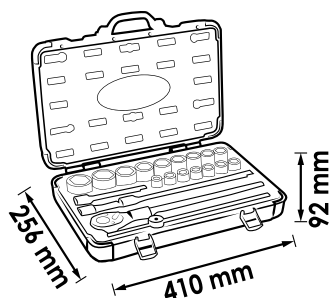

12⁵ 1/2"



Einzelteilaufistung ab Seite 150

XX	■		Ausführung	SW
18 x	12 ⁵ 1/2"	●		10 · 11 · 12 · 13 · 14 · 15 · 16 · 17 · 18 · 19 · 20 · 21 · 22 · 23 · 24 · 27 · 30 · 32 mm
2 x	12 ⁵ 1/2"	●		16 · 21 mm
1 x	-	12 ⁵ 1/2"		250 mm
1 x	12 ⁵ 1/2"	12 ⁵ 1/2"		125 mm
1 x	12 ⁵ 1/2"	12 ⁵ 1/2"		250 mm
1 x	12 ⁵ 1/2"	12 ⁵ 1/2"		75 mm
1 x	-	12 ⁵ 1/2"		250 mm



V7512/17, EAN 4047728074216

Doppelsechskant-Steckschlüssel Satz

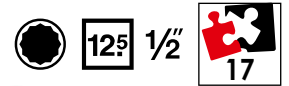

Einzelteilaufistung ab Seite 152

XX	■	●	Ausführung	SW
18 x	12.5 1/2	●		10 · 11 · 12 · 13 · 14 · 15 · 16 · 17 · 18 · 19 · 20 · 21 · 22 · 24 · 27 · 30 · 32 · 8 mm



V2496, EAN 4047728024969

Schraubendreher-Einsatz Satz

• Für Handbetätigung



Einzelteilaufistung ab Seite 154

XX	■	●	Ausführung	SW
8 x	12.5 1/2	○		M5 · M6 · M8 · M9 · M10 · M12 · M14 · M16
9 x	12.5 1/2	○		5 · 6 · 7 · 8 · 10 · 12 · 14 · 17 · 19 mm
9 x	12.5 1/2	⊛		M5 · M6 · M7 · M8 · M9 · M10 · M12 · M13 · M14
10 x	12.5 1/2	⊛		T20 · T25 · T27 · T30 · T40 · T45 · T50 · T55 · T60 · T70



V1917, EAN 4047728019170

T Schraubendreher-Einsatz Satz

• Für Handbetätigung

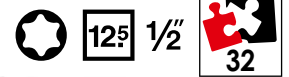

Einzelteilaufistung ab Seite 155

XX	■	⊕	Ausführung	SW
10 x	12.5	1/2		T20 · T25 · T27 · T30 · T40 · T45 · T50 · T55 · T60 · T70
10 x	12.5	1/2		T20 · T25 · T27 · T30 · T40 · T45 · T50 · T55 · T60 · T70
6 x	12.5	1/2		T40 · T45 · T50 · T55 · T60 · T70
6 x	12.5	1/2		T40 · T45 · T50 · T55 · T60 · T70



V1918, EAN 4047728019187

Innenvielzahn Schraubendreher-Einsatz Satz (XZN)

• Für Handbetätigung

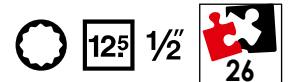

Einzelteilaufistung ab Seite 155

XX	■	⊕	Ausführung	SW
8 x	12.5	1/2		M5 · M6 · M8 · M9 · M10 · M12 · M14 · M16
7 x	12.5	1/2		M5 · M6 · M8 · M9 · M10 · M12 · M14
7 x	12.5	1/2		M5 · M6 · M8 · M10 · M12 · M14 · M9
4 x	12.5	1/2		M8 · M10 · M12 · M14



V1919, EAN 4047728019194

Innensechskant Schraubendreher-Einsatz Satz

• Für Handbetätigung

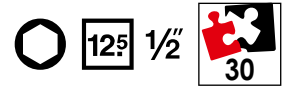

Einzelteilaufistung ab Seite 154

XX	■	○	Ausführung	SW
9 x	12.5 1/2	○		5 · 6 · 7 · 8 · 10 · 12 · 14 · 17 · 19 mm
8 x	12.5 1/2	○		5 · 6 · 7 · 8 · 10 · 11 · 12 · 13 mm
7 x	12.5 1/2	○		5 · 6 · 7 · 8 · 10 · 12 · 14 mm
6 x	12.5 1/2	○		5 · 6 · 7 · 8 · 10 · 12 mm



V2201, EAN 4047728022019

RIBE Schraubendreher-Einsatz Satz

• Für Handbetätigung

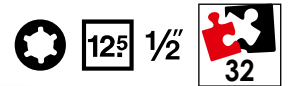

Einzelteilaufistung ab Seite 157

XX	■	○	Ausführung	SW
9 x	12.5 1/2	⊗		M5 · M6 · M7 · M8 · M9 · M10 · M12 · M13 · M14
9 x	12.5 1/2	⊗		M5 · M6 · M7 · M8 · M9 · M10 · M12 · M13 · M14
7 x	12.5 1/2	⊗		M8 · M9 · M10 · M10.3 · M12 · M13 · M14
7 x	12.5 1/2	⊗		M8 · M9 · M10 · M10.3 · M12 · M13 · M14



V7917, EAN 4047728**075831**

T Kugelkopf Schraubendreher-Einsatz Satz

- Schwenkwinkel: 20°
- Für Handbetätigung

12⁵ 1/2"

32

NEU



Einzelteilaufistung ab Seite 158

XX	■	⊙	Ausführung	SW
8 x	12 ⁵ 1/2"	⊙		T20 · T25 · T27 · T30 · T40 · T45 · T50 · T55
2 x	12 ⁵ 1/2"	⊙		T60 · T70
10 x	12 ⁵ 1/2"	⊙		T20 · T25 · T27 · T30 · T40 · T45 · T50 · T55 · T60 · T70
6 x	12 ⁵ 1/2"	⊙		T40 · T45 · T50 · T55 · T60 · T70
6 x	12 ⁵ 1/2"	⊙		T40 · T45 · T50 · T55 · T60 · T70



V7919, EAN 4047728**075817**

Innensechskant Kugelkopf Schraubendreher-Einsatz Satz

- Schwenkwinkel: 20°
- Für Handbetätigung

12⁵ 1/2"

30

NEU



Einzelteilaufistung ab Seite 159

XX	■	⊙	Ausführung	SW
7 x	12 ⁵ 1/2"	⊙		5 · 6 · 7 · 8 · 10 · 12 · 14 mm
2 x	12 ⁵ 1/2"	⊙		17 · 19 mm
8 x	12 ⁵ 1/2"	⊙		5 · 6 · 7 · 8 · 10 · 11 · 12 · 13 mm
7 x	12 ⁵ 1/2"	⊙		5 · 6 · 7 · 8 · 10 · 12 · 14 mm
6 x	12 ⁵ 1/2"	⊙		5 · 6 · 7 · 8 · 10 · 12 mm



V1898, EAN 4047728018982

Multiprofil Steckschlüsseinsatz Satz

• Für Handbetätigung

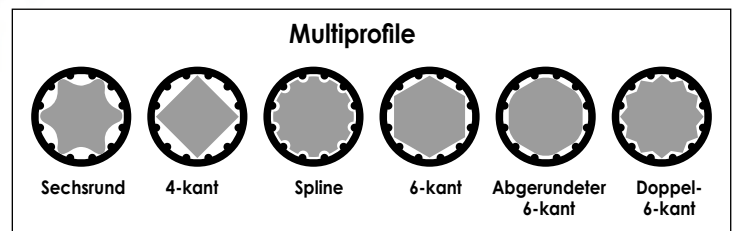
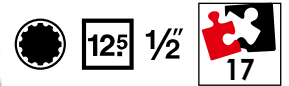

Alle Einsätze für 6 Profile geeignet

Einzelteilaufistung ab Seite 154

XX	■	Ausführung	SW
17 x	12.5 1/2		10 · 11 · 12 · 13 · 14 · 15 · 16 · 17 · 18 · 19 · 20 · 21 · 22 · 24 · 27 · 30 · 32 mm

V2404, EAN 4047728024044

Spiralnutenausdreher-Einsatz Satz

• Betätigung von Muttern mit rundgedrehten Köpfen (Spezialprofil)
• Für Handbetätigung

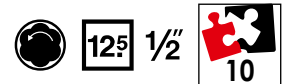

Einzelteilaufistung Seite 162

XX	■	Ausführung	SW
9 x	12.5 1/2		10 · 11 · 12 · 13 · 14 · 15 · 16 · 17 · 19 mm

V3741, EAN 4047728**037419**

Spiralnutenausdreher-Einsatz Satz

- Betätigung von Muttern mit rundgedrehten Köpfen (Spezialprofil)
- Für Handbetätigung

12⁵ 1/2

7



Einzelteilaufistung Seite 162

		Ausführung	SW
6 x	12 ⁵ 1/2		21 · 22 · 24 · 27 · 30 · 32 mm



V5550S, EAN 4047728**055819**

Schlagschrauber Steckschlüsseleinsatz Satz · kurz

- Oberfläche: phosphatiert
- Für Maschinenbetätigung

12⁵ 1/2

13

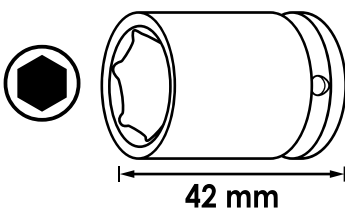

Einzelteilaufistung Seite 162

		Ausführung	SW
13 x	12 ⁵ 1/2		10 · 11 · 12 · 13 · 14 · 15 · 16 · 17 · 18 · 19 · 21 · 22 · 24 mm



V5550L, EAN 4047728055505

**Schlagschrauber
Steckschlüsseleinsatz Satz · lang**

- Oberfläche: phosphatiert
- Für Maschinenbetätigung

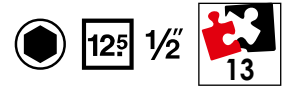

Einzelteilaufistung Seite 162

XX	■	●	Ausführung	SW
13 x	12.5 1/2	●		10 · 11 · 12 · 13 · 14 · 15 · 16 · 17 · 18 · 19 · 21 · 22 · 24 mm



V7017, EAN 4047728064705

**Schlagschrauber Schraubendreher-
Einsatz Satz für Innen T Profil**

- Oberfläche: phosphatiert
- Für Maschinenbetätigung

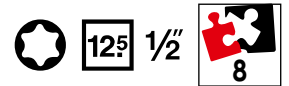

Einzelteilaufistung Seite 164

XX	■	●	Ausführung	SW
8 x	12.5 1/2	●		T30 · T40 · T45 · T50 · T55 · T60 · T70 · T80



V7019, EAN 4047728**066372**

Schlagschrauber Schraubendreher-Einsatz Satz für Innensechskant Profil

- Oberfläche: phosphatiert
- Für Maschinenbetätigung

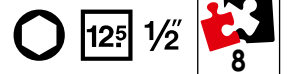

Einzelteilaufistung Seite 164

XX	■	○	Ausführung	SW
8 x	12.5 1/2	○		5 · 6 · 8 · 10 · 12 · 14 · 17 · 19 mm



V7018, EAN 4047728**066846**

Schlagschrauber Innenvielzahn Schraubendreher-Einsatz Satz (XZN)

- Oberfläche: phosphatiert
- Für Maschinenbetätigung

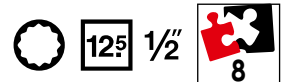

Einzelteilaufistung Seite 164

XX	■	○	Ausführung	SW
8 x	12.5 1/2	○		M5 · M6 · M8 · M10 · M12 · M14 · M16 · M18



V6012, EAN 4047728**055826**

Feinzahn-Umschaltknarre

- Gekröpfte Ausführung
- Kunststoffummantel
- Auslöseknopf
- DIN 3122, ISO 3315
- 72 Zähne
- 5° Betätigungswinkel
- Für Handbetätigung

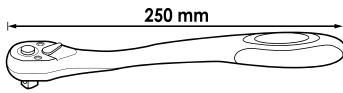

12.5 1/2

V6012-REP, EAN 4047728**056533**

Reparatur Satz

- Reparatur Satz für Feinzahn-Umschaltknarre V6012 · V6612



V6612, EAN 4047728**066464**

Teleskop Gelenk-Umschaltknarre

- Ausziehbar von 350 – 490 mm
- 180° Schwenkbarer Kopf inklusive Arretierung
- Auslöseknopf
- 72 Zähne
- 5° Betätigungswinkel
- Für Handbetätigung

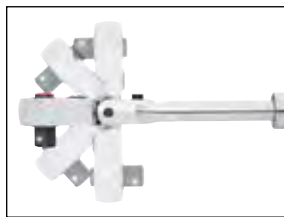

5 Positionen arretierbar

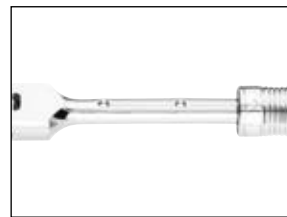

Auf verschiedene Fixierungspunkte einstellbar

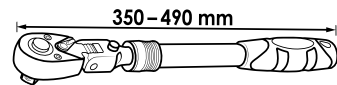

V6012-REP, EAN 4047728**056533**

Reparatur Satz

- Reparatur Satz für Feinzahn-Umschaltknarre V6012 · V6612



V4884, EAN 4047728**048842**

Gelenkgriff mit Umschaltknarre

- Vierkant-Antrieb mit Kugelarreterung
- DIN 3122
- 24 Zähne
- 15° Betätigungswinkel
- Für Handbetätigung



Robuster 24-Zahn Ratschenmechanismus



180°

12.5 1/2

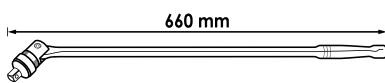

12.5 1/2

V4884-01, EAN 4047728**073226**

Knarrenkopf



V4946-S, EAN 4047728055369

Feinzahn-Umschaltknarre · Standard

- Robust und servicefreundlich
- Geschlossenes System
- Leicht zu reinigen
- DIN 3122, ISO 3315
- 72 Zähne
- 5° Betätigungswinkel
- Für Handbetätigung



Geschlossenes System



Robuste Vollstahl-Ausführung

12⁵ 1/2"

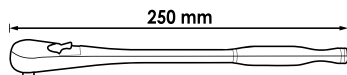

250 mm

12⁵ 1/2"

V4946-REP, EAN 4047728049498

Reparatur Satz

- Reparatur Satz für Feinzahn-Umschaltknarren V4946 · V4946-S



V5437, EAN 4047728054379

360° Drehgriff-Umschaltknarre

- Einsatz in beengten Bereichen
- Durchsteckvierkant für Rechts- / Linksbetrieb
- Standard-Betätigung durch Feststellen möglich
- Betätigung nur rechtslaufend
- 72 Zähne
- 5° Betätigungswinkel
- Für Handbetätigung



12⁵ 1/2"



Antriebsmechanismus im Griff

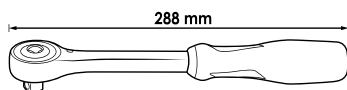

288 mm

12⁵ 1/2"

Lösen und Anziehen von Verschraubungen
nur im arretierten Modus



V7202-1, EAN 4047728069113

Umschaltknarre

- Flaches Einsatz-Profil – Direktes Ansetzen an der Mutter / Verschraubung
- Robuste Vollstahl-Umschaltknarre
- Rechts- und Linksbetrieb
- Ergonomischer Griff



12⁵ 1/2"

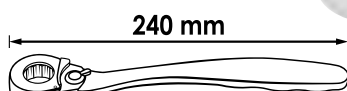

240 mm

12⁵ 1/2"



V2573N, EAN 4047728**058391**

Gleitgriff

12⁵ 1/2



V2667N, EAN 4047728**058728**

Gleitstück

12⁵ 1/2



Sechskant Steckschlüsseleinsatz

12⁵ 1/2



VIGOR No.	SW	L mm	EAN 4047728+
V4709N	8 mm	38	058902
V2465N	10 mm	38	058186
V2598N	11 mm	38	058629
V2603N	12 mm	38	058650
V2599N	13 mm	38	058636
V2600N	14 mm	38	058643
V2561N	15 mm	38	058261
V2562N	16 mm	38	058278
V2563N	17 mm	38	058285
V2564N	18 mm	38	058292

VIGOR No.	SW	L mm	EAN 4047728+
V2565N	19 mm	38	058308
V2566N	20 mm	38	058315
V2567N	21 mm	38	058322
V2568N	22 mm	38	058339
V2569N	23 mm	38	058346
V2570N	24 mm	38	058353
V2571N	27 mm	42	058360
V2572N	30 mm	44	058377
V2574N	32 mm	44	058384

Doppelsechskant Steckschlüsseleinsatz

12⁵ 1/2



VIGOR No.	SW	L mm	EAN 4047728+
V7512-8	8 mm	38	074339
V7512-10	10 mm	38	074346
V7512-11	11 mm	38	074353
V7512-12	12 mm	38	074360
V7512-13	13 mm	38	074377
V7512-14	14 mm	38	074384
V7512-15	15 mm	38	074391
V7512-16	16 mm	38	074407
V7512-17	17 mm	38	074414
V7512-18	18 mm	38	074421

VIGOR No.	SW	L mm	EAN 4047728+
V7512-19	19 mm	38	074438
V7512-20	20 mm	38	074445
V7512-21	21 mm	38	074452
V7512-22	22 mm	38	074469
V7512-23	23 mm	38	074476
V7512-24	24 mm	38	074483
V7512-27	27 mm	42	074490
V7512-30	30 mm	44	074506
V7512-32	32 mm	44	074513

Sechskant Steckschlüsseinsatz · lang



VIGOR No.	SW	L mm	EAN 4047728+
V2579N	10 mm	77	058445
V2580N	11 mm	77	058452
V2581N	12 mm	77	058469
V2584N	13 mm	77	058483
V2585N	14 mm	77	058490
V2586N	15 mm	77	058506
V2587N	16 mm	77	058513
V2588N	17 mm	77	058520
V2589N	18 mm	77	058537
V2590N	19 mm	77	058544
V2591N	22 mm	77	058551

Sechskant Steckschlüsseinsatz · superflach

- Flaches Einsatz-Profil – Direktes Ansetzen an der Mutter / Verschraubung



VIGOR No.	SW	EAN 4047728+	VIGOR No.	SW	EAN 4047728+
V7202-8	8 mm	069168	V7202-18	18 mm	069274
V7202-9	9 mm	069083	V7202-19	19 mm	069281
V7202-10	10 mm	069090	V7202-20	20 mm	069298
V7202-11	11 mm	069106	V7202-21	21 mm	069304
V7202-12	12 mm	069212	V7202-22	22 mm	069311
V7202-13	13 mm	069229	V7202-24	24 mm	069328
V7202-14	14 mm	069236	V7202-27	27 mm	069335
V7202-15	15 mm	069243	V7202-30	30 mm	069342
V7202-16	16 mm	069250	V7202-32	32 mm	069359
V7202-17	17 mm	069267			

T Steckschlüsseinsatz



VIGOR No.	SW	L mm	EAN 4047728+	VIGOR No.	SW	L mm	EAN 4047728+
V2730	E10	38	027304	V2196	E18	38.2	021968
V2731	E11	38	027311	V2197	E20	38.2	021975
V2732	E12	38	027328	V2735	E22	38	027359
V2733	E14	38	027335	V2592N	E24	38	058568
V2734	E16	38	027342				

Zündkerzen-Einsatz



VIGOR No.	SW	L mm	EAN 4047728+
V2578N	16 mm	66	058438
V2582N	21 mm	66	058476



Multiprofil Steckschlüsseleinsatz



VIGOR No.	SW	L mm	EAN 4047728+
V1988	10 mm	38.1	019880
V1989	11 mm	38.1	019897
V1990	12 mm	38.1	019903
V1991	13 mm	38.1	019910
V1992	14 mm	38.1	019927
V1993	15 mm	38.1	019934
V1994	16 mm	38.1	019941
V1995	17 mm	38.1	019958
V1996	18 mm	38.1	019965

VIGOR No.	SW	L mm	EAN 4047728+
V1997	19 mm	38.1	019972
V1998	20 mm	38.1	019989
V1999	21 mm	38.1	019996
V2000	22 mm	38.1	020008
V2001	24 mm	40	020015
V2002	27 mm	42	020022
V2003	30 mm	45	020039
V2004	32 mm	45	020046

Innensechskant Schraubendreher-Einsatz



VIGOR No.	SW	L mm	EAN 4047728+
V2101	5 mm	55	021012
V2102	6 mm	55	021029
V2103	7 mm	55	021036
V2104	8 mm	55	021043
V2105	10 mm	55	021050

VIGOR No.	SW	L mm	EAN 4047728+
V2106	12 mm	55	021067
V2107	14 mm	55	021074
V2069	17 mm	55	020695
V2070	19 mm	55	020701

Innensechskant Schraubendreher-Einsatz



VIGOR No.	SW	L mm	EAN 4047728+
V2072	5 mm	100	020725
V2073	6 mm	100	020732
V2074	7 mm	100	020749
V2075	8 mm	100	020756

VIGOR No.	SW	L mm	EAN 4047728+
V2076	10 mm	100	020763
V2077	11 mm	100	020770
V2078	12 mm	100	020787
V2079	13 mm	100	020794

Innensechskant Schraubendreher-Einsatz



VIGOR No.	SW	L mm	EAN 4047728+
V2080	5 mm	140	020800
V2081	6 mm	140	020817
V2082	7 mm	140	020824
V2083	8 mm	140	020831
V2084	10 mm	140	020848
V2085	12 mm	140	020855
V2086	14 mm	140	020862

Innensechskant Schraubendreher-Einsatz



VIGOR No.	SW	L mm	EAN 4047728+
V2087	5 mm	200	020879
V2088	6 mm	200	020886
V2089	7 mm	200	020893
V2090	8 mm	200	020909
V2091	10 mm	200	020916
V2092	12 mm	200	020923

Innenvielzahn Schraubendreher-Einsatz (XZN)



VIGOR No.	SW	L mm	EAN 4047728+
V2094	M5	55	020947
V2095	M6	55	020954
V2096	M8	55	020961
V2097	M9	55	020978

VIGOR No.	SW	L mm	EAN 4047728+
V2098	M10	55	020985
V2099	M12	55	020992
V2065	M14	55	020657
V2100	M16	55	021005

Innenvielzahn Schraubendreher-Einsatz (XZN)



VIGOR No.	SW	L mm	EAN 4047728+
V2066	M5	100	020664
V2068	M6	100	020688
V2067	M8	100	020671
V2113	M9	100	021135
V2059	M10	100	020596
V2060	M12	100	020602
V2121	M14	100	021210

Innenvielzahn Schraubendreher-Einsatz (XZN)



VIGOR No.	SW	L mm	EAN 4047728+
V2122	M5	140	021227
V2124	M6	140	021241
V2123	M8	140	021234
V2126	M9	140	021265
V2128	M10	140	021289
V2129	M12	140	021296
V2132	M14	140	021326

Innenvielzahn Schraubendreher-Einsatz (XZN)



VIGOR No.	SW	L mm	EAN 4047728+
V2133	M8	200	021333
V2134	M10	200	021340
V2135	M12	200	021357
V2137	M14	200	021371

T Schraubendreher-Einsatz



VIGOR No.	SW	L mm	EAN 4047728+
V2151	T20	55	021517
V2152	T25	55	021524
V2153	T27	55	021531
V2154	T30	55	021548
V2155	T40	55	021555

VIGOR No.	SW	L mm	EAN 4047728+
V2156	T45	55	021562
V2157	T50	55	021579
V2158	T55	55	021586
V2159	T60	55	021593
V2160	T70	55	021609



T Schraubendreher-Einsatz



VIGOR No.	SW	mm	EAN 4047728+
V2161	T20	100	021616
V2162	T25	100	021623
V2163	T27	100	021630
V2165	T30	100	021654
V2167	T40	100	021678

VIGOR No.	SW	mm	EAN 4047728+
V2168	T45	100	021685
V2169	T50	100	021692
V2170	T55	100	021708
V2171	T60	100	021715
V2172	T70	100	021722

T Schraubendreher-Einsatz



VIGOR No.	SW	mm	EAN 4047728+
V2173	T40	140	021739
V2174	T45	140	021746
V2175	T50	140	021753
V2176	T55	140	021760
V2177	T60	140	021777
V2178	T70	140	021784

T Schraubendreher-Einsatz



VIGOR No.	SW	mm	EAN 4047728+
V2179	T40	200	021791
V2180	T45	200	021807
V2181	T50	200	021814
V2182	T55	200	021821
V2183	T60	200	021838
V2184	T70	200	021845

T-Plus Schraubendreher-Einsatz

NEU



VIGOR No.	SW	EAN 4047728+
V7055-IP40	T40+	078344
V7055-IP45	T45+	078351
V7055-IP50	T50+	078368
V7055-IP55	T55+	078375
V7055-IP60	T60+	078382

T-Plus Schraubendreher-Einsatz

NEU



VIGOR No.	SW	EAN 4047728+
V7055-IPR40	T40+H	078467
V7055-IPR45	T45+H	078474
V7055-IPR50	T50+H	078481
V7055-IPR55	T55+H	078498
V7055-IPR60	T60+H	078504

T Schraubendreher-Einsatz



NEU

12.5 1/2"

VIGOR No.	SW	EAN 4047728+
V7055-T40H	T40H	078511
V7055-T45H	T45H	078528
V7055-T50H	T50H	078535
V7055-T55H	T55H	078542
V7055-T60H	T60H	078559

RIBE Schraubendreher-Einsatz



12.5 1/2"

VIGOR No.	SW	L mm	EAN 4047728+
V2202	M5	55	022026
V2203	M6	55	022033
V2204	M7	55	022040
V2205	M8	55	022057
V2206	M9	55	022064

VIGOR No.	SW	L mm	EAN 4047728+
V2207	M10	55	022071
V2208	M12	55	022088
V2209	M13	55	022095
V2210	M14	55	022101

RIBE Schraubendreher-Einsatz



12.5 1/2"

VIGOR No.	SW	L mm	EAN 4047728+
V2211	M5	100	022118
V2212	M6	100	022125
V2213	M7	100	022132
V2214	M8	100	022149
V2215	M9	100	022156

VIGOR No.	SW	L mm	EAN 4047728+
V2216	M10	100	022163
V2217	M12	100	022170
V2218	M13	100	022187
V2219	M14	100	022194

RIBE Schraubendreher-Einsatz



12.5 1/2"

VIGOR No.	SW	L mm	EAN 4047728+
V2220	M8	140	022200
V2221	M9	140	022217
V2222	M10	140	022224
V2223	M10.3	140	022231
V2224	M12	140	022248
V2225	M13	140	022255
V2226	M14	140	022262



RIBE Schraubendreher-Einsatz



VIGOR No.	SW	← L → mm	EAN 4047728+
V2227	M8	200	022279
V2228	M9	200	022286
V2229	M10	200	022293
V2230	M10.3	200	022309
V2231	M12	200	022316
V2232	M13	200	022323
V2233	M14	200	022330

T Kugelpf Schraubendreher-Einsatz



VIGOR No.	SW	← L → mm	EAN 4047728+
V7055-T20	T20	55	075954
V7055-T25	T25	55	075961
V7055-T27	T27	55	075978
V7055-T30	T30	55	075985

VIGOR No.	SW	← L → mm	EAN 4047728+
V7055-T40	T40	55	075992
V7055-T45	T45	55	076005
V7055-T50	T50	55	076012
V7055-T55	T55	55	076029

T Kugelpf Schraubendreher-Einsatz



VIGOR No.	SW	← L → mm	EAN 4047728+
V7075-T60	T60	75	076036
V7075-T70	T70	75	076043

T Kugelpf Schraubendreher-Einsatz



VIGOR No.	SW	← L → mm	EAN 4047728+
V7100-T20	T20	100	076050
V7100-T25	T25	100	076067
V7100-T27	T27	100	076074
V7100-T30	T30	100	076081
V7100-T40	T40	100	076098

VIGOR No.	SW	← L → mm	EAN 4047728+
V7100-T45	T45	100	076104
V7100-T50	T50	100	076234
V7100-T55	T55	100	076241
V7100-T60	T60	100	076258
V7100-T70	T70	100	076265

T Kugelpf Schraubendreher-Einsatz



VIGOR No.	SW	← L → mm	EAN 4047728+
V7140-T40	T40	140	076272
V7140-T45	T45	140	076289
V7140-T50	T50	140	076296
V7140-T55	T55	140	076302
V7140-T60	T60	140	076319
V7140-T70	T70	140	076326

T Kugelkopf Schraubendreher-Einsatz



VIGOR No.	SW	mm	EAN 4047728+
V7200-T40	T40	200	076333
V7200-T45	T45	200	076340
V7200-T50	T50	200	076357
V7200-T55	T55	200	076364
V7200-T60	T60	200	076371
V7200-T70	T70	200	076388

Innensechskant Schraubendreher-Einsatz



VIGOR No.	SW	mm	EAN 4047728+
V7055-H5	5 mm	55	076395
V7055-H6	6 mm	55	076401
V7055-H7	7 mm	55	076418
V7055-H8	8 mm	55	076425
V7055-H10	10 mm	55	076432
V7055-H12	12 mm	55	076449
V7055-H14	14 mm	55	076456

Innensechskant Schraubendreher-Einsatz



VIGOR No.	SW	mm	EAN 4047728+
V7075-H17	17 mm	75	076463
V7075-H19	19 mm	75	076470

Innensechskant Schraubendreher-Einsatz



VIGOR No.	SW	mm	EAN 4047728+
V7100-H5	5 mm	100	076487
V7100-H6	6 mm	100	076517
V7100-H7	7 mm	100	076524
V7100-H8	8 mm	100	076531
V7100-H10	10 mm	100	076548
V7100-H11	11 mm	100	076555
V7100-H12	12 mm	100	076562
V7100-H13	13 mm	100	076579

Innensechskant Schraubendreher-Einsatz



VIGOR No.	SW	mm	EAN 4047728+
V7140-H5	5 mm	140	076586
V7140-H6	6 mm	140	076593
V7140-H7	7 mm	140	076609
V7140-H8	8 mm	140	076616
V7140-H10	10 mm	140	076623
V7140-H12	12 mm	140	076630
V7140-H14	14 mm	140	076647



Innensechskant Schraubendreher-Einsatz

12⁵ 1/2



VIGOR No.	SW	← L → mm	EAN 4047728+
V7200-H5	5 mm	200	076654
V7200-H6	6 mm	200	076661
V7200-H7	7 mm	200	076678
V7200-H8	8 mm	200	076685
V7200-H10	10 mm	200	076692
V7200-H12	12 mm	200	076708

Universalgelenk

12⁵ 1/2 12⁵ 1/2



VIGOR No.	← L → mm	EAN 4047728+
V2575N	75	058407

Universalgelenk

12⁵ 1/2 12⁵ 1/2



VIGOR No.	EAN 4047728+
V7202-3	069137

Verlängerung

12⁵ 1/2 12⁵ 1/2



VIGOR No.	← L → mm	EAN 4047728+
V2576N	125	058414
V2577N	250	058421
V4398N	750	058896

Schwenkbare Verlängerung

- Befähigung von Schraubverbindungen auf engem Raum und Umgehen von Störkanten
- Kugelförmiger, konischer Außenvierkant

12⁵ 1/2 12⁵ 1/2



VIGOR No.	← L → mm	EAN 4047728+
V4317	50	043175
V4318	75	043182
V4319	250	043199

Verlängerung

125 1/2" **125** 1/2"



VIGOR No.	mm	EAN 4047728+
V7202-4	125	069144
V7202-5	250	069151

Adapter

10 3/8" **125** 1/2"



VIGOR No.	mm	EAN 4047728+
V2109	36	021098

Adapter

20 3/4" **125** 1/2"



VIGOR No.	mm	EAN 4047728+
V2110	46	021104

Bit Adapter

8 5/16" **125** 1/2"



VIGOR No.	mm	EAN 4047728+
V2647N	37	058711

Vierkant Adapter

◆ 22 mm

125 1/2"



VIGOR No.	EAN 4047728+
V7202-2	069120



Schlagschrauber Steckschlüsseleinsatz · kurz

- Oberfläche: phosphatiert
- Für Maschinenbetätigung

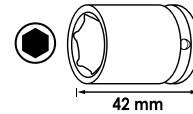

12⁵ 1/2"

VIGOR No.	SW	EAN 4047728+
V5550S-10	10 mm	056175
V5550S-11	11 mm	056182
V5550S-12	12 mm	056199
V5550S-13	13 mm	056205
V5550S-14	14 mm	056212
V5550S-15	15 mm	056229
V5550S-16	16 mm	056236
V5550S-17	17 mm	056243
V5550S-18	18 mm	056250
V5550S-19	19 mm	056267
V5550S-21	21 mm	056274
V5550S-22	22 mm	056281
V5550S-24	24 mm	056298

Schlagschrauber Steckschlüsseleinsatz · lang

- Oberfläche: phosphatiert
- Für Maschinenbetätigung

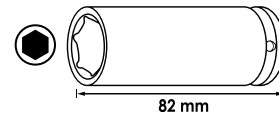

12⁵ 1/2"

VIGOR No.	SW	EAN 4047728+
V5550L-10	10 mm	056045
V5550L-11	11 mm	056052
V5550L-12	12 mm	056069
V5550L-13	13 mm	056076
V5550L-14	14 mm	056083
V5550L-15	15 mm	056090
V5550L-16	16 mm	056106
V5550L-17	17 mm	056113
V5550L-18	18 mm	056120
V5550L-19	19 mm	056137
V5550L-21	21 mm	056144
V5550L-22	22 mm	056151
V5550L-24	24 mm	056168

Spiralnutenausdreher-Einsatz

- Betätigung von Muttern mit rundgedrehten Köpfen (Spezialprofil)



12⁵ 1/2"

VIGOR No.	SW	L mm	EAN 4047728+
V2405	10 mm	34	024051
V2402	11 mm	34	024020
V2406	12 mm	34	024068
V2407	13 mm	34	024075
V2401	14 mm	34	024013
V2408	15 mm	34	024082
V2403	16 mm	34	024037
V2409	17 mm	34	024099
V2410	19 mm	34	024105
V3742	21 mm	34	037426
V3743	22 mm	34	037433
V3744	24 mm	34	037440
V3745	27 mm	34	037457
V3746	30 mm	34	037464
V3747	32 mm	34	037471

Schlagschrauber Steckschlüsseleinsatz (Doppel-6kt.) · kurz

- Extra dünnwandiger Steckschlüsseleinsatz für Gelenkwellen-Verschraubungen in der Radnabe
- Bohrung für Sicherungsstift oder Sicherungsfeder und Rille für O-Ring
- Angepasst an gegebene Platzverhältnisse in der Radnabe
- Für z.B.
 - VW Touareg Bj. 2003 →
 - AUDI A4 Bj. 2001 → · A6 Bj. 2005 → · A8 Bj. 2003 → · Q7 Bj. 2007 →
 - Weitere Modelle
- Für Maschinenbetätigung

● 32 mm

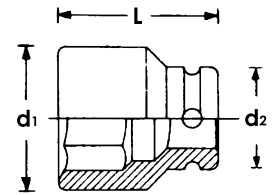

VIGOR No.	d1 mm	d2 mm	SW	L mm	EAN
V4477	44.4	30	32 mm	50	4047728+ 044776

Schlagschrauber Steckschlüsseleinsatz (Doppel-6kt.) · kurz

- Extra dünnwandiger Steckschlüsseleinsatz für Gelenkwellen-Verschraubungen in der Radnabe
- Bohrung für Sicherungsstift oder Sicherungsfeder und Rille für O-Ring
- Angepasst an gegebene Platzverhältnisse in der Radnabe
- Für z.B.: OPEL Corsa D Bj. 2006 →, Adam Bj. 2012 →, Mokka Bj. 2012 → · CHEVROLET/GMC Trax Bj. 2013 →
- Weitere Modelle
- Ebenfalls für BMW · SEAT und VW Fahrzeuge
- Für Maschinenbetätigung

● 36 mm

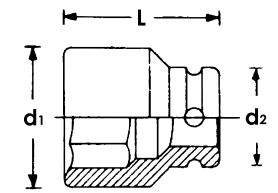

VIGOR No.	d1 mm	d2 mm	SW	L mm	EAN
V4478	46.9	30	36 mm	50	4047728+ 044783



Schlagschrauber Schraubendreher-Einsatz

- Oberfläche: phosphatiert
- Für Maschinenbetätigung



VIGOR No.	SW	← L → mm	EAN 4047728+
V7017-T30	T30	78	066389
V7017-T40	T40	78	066396
V7017-T45	T45	78	066402
V7017-T50	T50	78	066419
V7017-T55	T55	78	066426
V7017-T60	T60	78	066242
V7017-T70	T70	78	066259
V7017-T80	T80	78	066266

Schlagschrauber Schraubendreher-Einsatz

- Oberfläche: phosphatiert
- Für Maschinenbetätigung



VIGOR No.	SW	← L → mm	EAN 4047728+
V7018-M5	M5	78	066273
V7018-M6	M6	78	066280
V7018-M8	M8	78	066297
V7018-M10	M10	78	066303
V7018-M12	M12	78	066518
V7018-M14	M14	78	066525
V7018-M16	M16	78	066532
V7018-M18	M18	78	066549

Schlagschrauber Schraubendreher-Einsatz

- Oberfläche: phosphatiert
- Für Maschinenbetätigung



VIGOR No.	SW	← L → mm	EAN 4047728+
V7019-H5	5 mm	78	066556
V7019-H6	6 mm	78	066563
V7019-H8	8 mm	78	066570
V7019-H10	10 mm	78	066587
V7019-H12	12 mm	78	066594
V7019-H14	14 mm	78	066600
V7019-H17	17 mm	78	066617
V7019-H19	19 mm	78	066624

V2318N, EAN 4047728**059299**

Steckschlüssel Satz

- 24 Zähne
- 15° Betätigungswinkel
- Für Handbetätigung

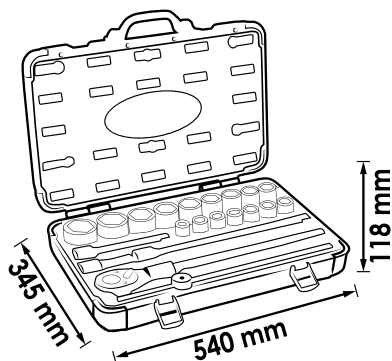
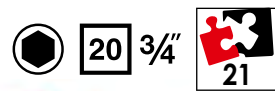

xx			Ausführung	SW
16 x	20 3/4	●		19 · 21 · 22 · 23 · 24 · 26 · 27 · 28 · 30 · 32 · 34 · 36 · 38 · 41 · 46 · 50 mm
1 x	-	20 3/4		500 mm
1 x	20 3/4	20 3/4		100 mm
1 x	20 3/4	20 3/4		200 mm
1 x	20 3/4	20 3/4		400 mm
1 x	-	20 3/4		450 mm



Umschaltknarre

- 24 Zähne
- 15° Betätigungswinkel
- Für Handbetätigung

20 3/4



VIGOR No.	L mm	EAN
V2319N	500	4047728+ 059282

Gleitgriff

- Für Handbetätigung

20 3/4



VIGOR No.	L mm	EAN
V2322N	450	4047728+ 057158

Adapter

12⁵ 1/2 **20 3/4**



VIGOR No.	L mm	EAN
V2111	50	4047728+ 021111



Verlängerung

20 3/4" 20 3/4"



VIGOR No.	L mm	EAN 4047728+
V2320N	100	057561
V2321N	200	057578
V2317N	400	057554

Steckschlüsseinsatz

20 3/4"



VIGOR No.	SW	L mm	EAN 4047728+
V2323N	19 mm	50	057165
V2324N	21 mm	50	057172
V2325N	22 mm	50	057189
V2326N	23 mm	50	057196
V2327N	24 mm	50	057202
V2328N	26 mm	50	057615
V2329N	27 mm	52	057622
V2256N	28 mm	52	057059
V2924N	30 mm	54	057639
V2331N	32 mm	56	057646
V2332N	34 mm	58	057653
V2333N	36 mm	58	057677
V2334N	38 mm	60	057684
V2337N	41 mm	64	057721
V2336N	46 mm	68	057707
V2335N	50 mm	68	057691

V5024, EAN 4047728050241

Schlagschrauber Steckschlüsseinsatz Satz

- Extra dünnwandige Steckschlüssel-Einsätze für Antriebswellen-Verschraubungen in der Radnabe
- Angepasst an gegebene Platzverhältnisse in der Radnabe
- Unter anderem für:
 - SW 24: VW Touran Bj. 2006 →
 - SW 30: VW Passat C, Golf 4, Polo, New Beetle · AUDI TT · ŠKODA Octavia, Superb, Fabia
 - SW 32: VW Touareg Bj. 2003 →
 - SW 36: BMW 3er · 5er · 7er · SEAT Ibiza · VW Polo, Golf Plus · OPEL Corsa D · Adam · Mokka · CHEVROLET Trax Bj. → 2013 · FIAT 500 · Grande Punto · Punto Evo Bj. → 2005 · FORD Ka · MERCEDES-BENZ S-Klasse · JAGUAR XJ40 · XJ181
- Für Maschinenbetätigung

20 3/4" 4



VIGOR No.	d1 mm	d2 mm	SW	L mm	EAN 4047728+
V5025	44.3	35	24 mm	44	050258
V5026	44.3	42	30 mm	50	050265
V5182	44.3	44.3	32 mm	50	051828
V5183	44.3	46.9	36 mm	50	051835

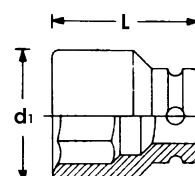

V7212, EAN 4047728072120

Schlagschrauber Schraubendreher-Einsatz Satz

- Gängige Verschraubungen VAG Fahrzeuge, z.B. Bremsträger, zentrale Antriebswellen, Stoßdämpfer oder geschraubte Radlagereinheiten
- Oberfläche: brüniert, geölt
- Für Maschinenbetätigung

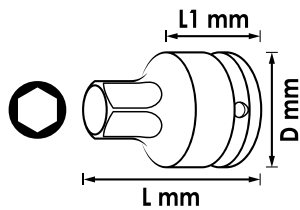
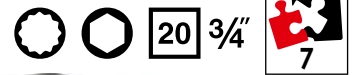

VIGOR No.	d2 mm	SW	L1 mm	L mm	EAN 4047728+
V7212-H14	44	14 mm	30	60	072168
V7212-H17	44	17 mm	30	60	072175
V7212-H19	44	19 mm	30	60	072182
V7212-H21	44	21 mm	30	60	072199
V7212-M14	44	M14	30	60	072137
V7212-M16	44	M16	30	60	072144
V7212-M18	44	M18	30	60	072151



V6039, EAN 4047728055857

Feinzahn-Umschaltknarren Satz

- Gekröpfte Ausführung
- Kunststoffummantelt
- Auslöseknopf
- Inhalt:
 - V6014 $6.3 \frac{1}{4}$ "
 - V6012 $12.5 \frac{1}{2}$ "
- DIN 3122, ISO 3315
- 72 Zähne
- 5° Betätigungswinkel
- Für Handbetätigung

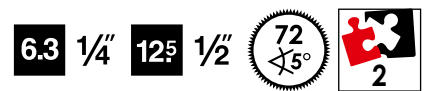

Mit Auslöseknopf

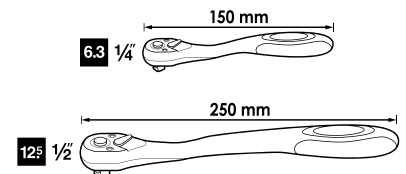

V5505, EAN 4047728055055

Schlagschrauber Gelenstück Satz

- Arbeiten an schwer zugänglichen Stellen, sowie zur Umgehung von Störkanten
- Bohrung für Sicherungsstift oder Sicherungsfeder und Rille für O-Ring
- Für Maschinenbetätigung

6.3 1/4 10 3/8 12⁵ 1/2 6.3 1/4 10 3/8 12⁵ 1/2



VIGOR No.	EAN 4047728+
V5505-1/4	055062
V5505-3/8	055079
V5505-1/2	055086



V1293, EAN 4047728012935

Adapter Satz

- Für Handbetätigung

6.3 1/4 10 3/8 12⁵ 1/2 20 3/4 6.3 1/4 10 3/8 12⁵ 1/2 20 3/4



Einzelteilaufistung ab Seite 127

xx	■		Ausführung	SW
1 x	6.3 1/4	10 3/8		26 mm
1 x	10 3/8	6.3 1/4		27 mm
1 x	10 3/8	12 ⁵ 1/2		36 mm
1 x	12 ⁵ 1/2	10 3/8		36 mm
1 x	12 ⁵ 1/2	20 3/4		46 mm
1 x	20 3/4	12 ⁵ 1/2		50 mm



V2687, EAN 4047728**026871**

T Steckschlüsseinsatz Satz

• Für Handbetätigung



Einzelteilaufistung ab Seite 123

	■		Ausführung	SW
7 x				E4 · E5 · E6 · E7 · E8 · E10 · E11
12 x				E4 · E5 · E6 · E7 · E8 · E10 · E11 · E12 · E14 · E16 · E18 · E20
9 x				E10 · E11 · E12 · E14 · E16 · E18 · E20 · E22 · E24



V1781, EAN 4047728**017817**

T Steckschlüsseinsatz Satz

• Für Handbetätigung



Einzelteilaufistung ab Seite 123

	■		Ausführung	SW
5 x				E4 · E5 · E6 · E7 · E8
1 x				T27
5 x				T9H · T10H · T15H · T25H · T30H
4 x				E10 · E12 · E14 · E16
4 x				T40 · T45 · T47 · T50
2 x				T45H · T50H
2 x				E18 · E20
2 x				T55 · T60
1 x				T55H



V7920, EAN 4047728077781

T-Plus Steckschlüsseinsatz Satz

- T-Plus Profile werden unter anderem bei BMW · VAG · MERCEDES-BENZ · AUDI · MAN · FORD · OPEL · MAZDA · TOYOTA · NISSAN · RENAULT · SUBARU · GM verbaut
- EP: Getriebe · Kupplung und Schwungscheibe
- IP: Radlager · Motor · Getriebe · Nockenversteller · Schwungscheibe · Zahnriemengehäuse
- IPR: Motor · Steuergerät · Lichtmaschinen · Außenspiegel · Steckpumpen · Luftmengenmesser



NEU



Einzelteilaufistung ab Seite 123

XX	■		Ausführung	SW
5 x	6.3	1/4"		E4 · E5 · E6 · E7 · E8
4 x	10	3/8"		E10 · E12 · E14 · E16
4 x	12.5	1/2"		E18 · E20 · E22 · E24
7 x	6.3	1/4"		T9 · T10 · T15 · T20 · T25 · T27 · T30
6 x	12.5	1/2"		T40 · T45 · T50 · T55 · T60 · T70
7 x	6.3	1/4"		T9H · T10H · T15H · T20H · T25H · T27H · T30H
5 x	12.5	1/2"		T40H · T45H · T50H · T55H · T60H
13 x	10	3/8"		EP4 · EP5 · EP6 · EP7 · EP8 · EP10 · EP12 · EP14 · EP16 · EP18 · EP20 · EP22 · EP24
7 x	6.3	1/4"		IP8IP · T10IP · T15IP · T20IP · T25IP · T27IP · T30IP
5 x	12.5	1/2"		T40IP · T45IP · T50IP · T55IP · T60IP
7 x	6.3	1/4"		IP8IRP · T10IRP · T15IRP · T20IRP · T25IRP · T27IRP · T30IRP
5 x	12.5	1/2"		T40IRP · T45IRP · T50IRP · T55IRP · T60IRP

Satz enthält alle T-Plus Profile

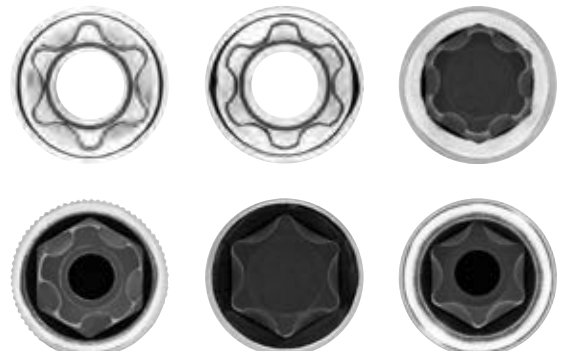

Steckschlüssel Systeme



V1706N, EAN 4047728056465

Steckschlüssel Satz

• Für Handbetätigung

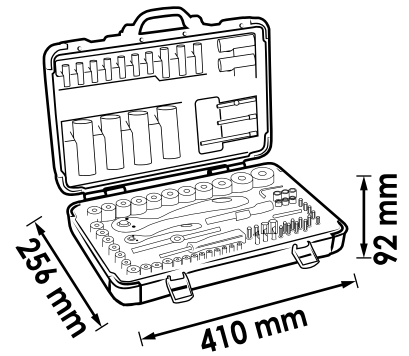

Einzelteilaufistung ab Seite 120

XX	■	□	Ausführung	SW
4 x	8 5/16	⊕	T40 · T45 · T50 · T55	
4 x	8 5/16	○	8 · 10 · 12 · 14 mm	
2 x	8 5/16	⊕	PH3 · PH4	
2 x	8 5/16	⊕	PZ3 · PZ4	
3 x	8 5/16	⊖	1.6x8 · 2x12 · 1.6x10 mm	
2 x	-	-	-	45.5 · 51 mm
1 x	-	○	┌	2 mm
1 x	6.3 1/4	6.3 1/4	┌	25 mm
1 x	12.5 1/2	8 5/16	┌	37 mm
1 x	-	6.3 1/4	┌	150 mm
1 x	6.3 1/4	6.3 1/4	┌	110 mm
1 x	-	12.5 1/2	┌	43.7 mm
4 x	6.3 1/4	○	┌	3 · 4 · 5 · 6 mm
3 x	6.3 1/4	⊖	┌	0.8x4 · 1x5.5 · 1.2x7 mm
2 x	6.3 1/4	⊕	┌	PH1 · PH2
2 x	6.3 1/4	⊕	┌	PZ1 · PZ2

XX	■	□	Ausführung	SW
5 x	6.3 1/4	⊕	┌	T10 · T15 · T20 · T25 · T30
18 x	12.5 1/2	○	┌	10 · 11 · 12 · 13 · 14 · 15 · 16 · 17 · 18 · 19 · 20 · 21 · 22 · 23 · 24 · 27 · 30 · 32 mm
4 x	12.5 1/2	○	┌	14 · 15 · 17 · 19 mm
13 x	6.3 1/4	○	┌	4 · 4.5 · 5 · 5.5 · 6 · 7 · 8 · 9 · 10 · 11 · 12 · 13 · 14 mm
8 x	6.3 1/4	○	┌	6 · 7 · 8 · 9 · 10 · 11 · 12 · 13 mm
1 x	-	6.3 1/4	┌	150 mm
1 x	-	12.5 1/2	┌	250 mm
1 x	6.3 1/4	6.3 1/4	┌	40 mm
1 x	12.5 1/2	12.5 1/2	┌	75 mm
1 x	6.3 1/4	6.3 1/4	┌	50 mm
1 x	6.3 1/4	6.3 1/4	┌	100 mm
1 x	6.3 1/4	6.3 1/4	┌	145 mm
1 x	12.5 1/2	12.5 1/2	┌	125 mm
1 x	12.5 1/2	12.5 1/2	┌	250 mm
2 x	12.5 1/2	○	┌	16 · 21 mm



Steckschlüssel Systeme



V3277N, EAN 4047728056489

Steckschlüssel Satz

• Für Handbetätigung

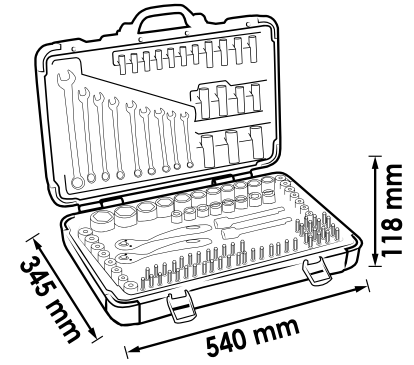

Einzelteilaufistung ab Seite 120

XX	■	■	Ausführung	SW
3 x	6.3 1/4	+		PH1 · PH2 · PH3
3 x	6.3 1/4	+		PZ1 · PZ2 · PZ3
3 x	6.3 1/4	●		1x 5.5 · 1x 6 · 1.6x 8 mm
5 x	6.3 1/4	○		3 · 4 · 5 · 6 · 7 mm
6 x	6.3 1/4	+		T15H · T20H · T25H · T27H · T30H · T40H
10 x	6.3 1/4	+		T10 · T15 · T20 · T25 · T27 · T30 · T40 · T45 · T8 · T9
4 x	8 5/16	○		7 · 8 · 10 · 12 mm
3 x	8 5/16	●		1.6x 8 · 1.6x 10 · 2x 12 mm
3 x	8 5/16	+		PH2 · PH3 · PH4
3 x	8 5/16	+		PZ2 · PZ3 · PZ4
5 x	8 5/16	+		T40 · T45 · T50 · T55 · T60
5 x	8 5/16	+		T40H · T45H · T50H · T55H · T60H
4 x	8 5/16	+		R10 · R11 · R12 · R13
2 x	8 5/16	○		M10 · M12
1 x	-	6.3 1/4		200 mm
4 x	-	○		1.3 · 2 · 45.5 · 51 mm
12 x	-	●●		8 · 9 · 10 · 11 · 12 · 13 · 14 · 15 · 17 · 19 · 22 · 24 mm
1 x	10 3/8	8 5/16		28 mm
1 x	12.5 1/2	8 5/16		37 mm
1 x	6.3 1/4	6.3 1/4		25 mm
1 x	-	6.3 1/4		150 mm
10 x	10 3/8	●		11 · 10 · 12 · 13 · 14 · 15 · 16 · 17 · 18 · 19 mm

XX	■	■	Ausführung	SW
6 x	10 3/8	●		E18 · E16 · E14 · E12 · E11 · E10
6 x	10 3/8	●		10 · 11 · 12 · 13 · 14 · 15 mm
14 x	12.5 1/2	●		13 · 14 · 15 · 16 · 17 · 18 · 19 · 20 · 21 · 22 · 24 · 27 · 30 · 32 mm
3 x	12.5 1/2	●		E24 · E22 · E20
5 x	12.5 1/2	●		16 · 17 · 18 · 19 · 22 mm
13 x	6.3 1/4	●		4 · 4.5 · 5 · 5.5 · 6 · 7 · 8 · 9 · 10 · 11 · 12 · 13 · 14 mm
5 x	6.3 1/4	●		E8 · E7 · E6 · E5 · E4
7 x	6.3 1/4	●		4 · 5 · 6 · 7 · 8 · 9 · 10 mm
1 x	-	6.3 1/4		150 mm
1 x	-	10 3/8		198 mm
1 x	-	12.5 1/2		250 mm
1 x	12.5 1/2	12.5 1/2		75 mm
1 x	10 3/8	10 3/8		50 mm
1 x	6.3 1/4	6.3 1/4		40 mm
1 x	12.5 1/2	12.5 1/2		125 mm
1 x	10 3/8	10 3/8		125 mm
1 x	6.3 1/4	6.3 1/4		100 mm
1 x	6.3 1/4	6.3 1/4		50 mm
1 x	12.5 1/2	12.5 1/2		250 mm
2 x	12.5 1/2	●		21 · 16 mm
1 x	10 3/8	●		18 mm



V4425N, EAN 4047728058919

Werkzeugkoffer · universal

• Werkzeug-Koffer inklusive Sortiment

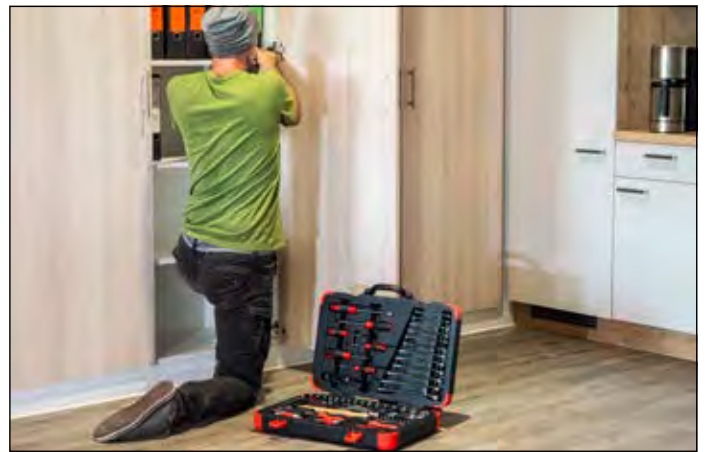

Einzelteilaufistung ab Seite 120

XX	■		Ausführung	SW
12 x	-			8 · 9 · 10 · 11 · 12 · 13 · 14 · 15 · 16 · 17 · 18 · 19 mm
4 x	-			0.6x3 · 0.8x4 · 1x5.5 · 1.2x6.5 mm
3 x	-			PH0 · PH1 · PH2
1 x	-	-		90 mm
1 x	-	-		160 mm
1 x	-	-		200 mm
1 x	-	-		300 g
1 x	6.3 1/4	6.3 1/4		100 mm
1 x	6.3 1/4	6.3 1/4		40 mm
11 x	6.3 1/4			4 · 5 · 5.5 · 6 · 7 · 8 · 9 · 10 · 11 · 12 · 13 mm
1 x	125 1/2	125 1/2		125 mm

XX	■		Ausführung	SW
1 x	125 1/2	125 1/2		75 mm
16 x	125 1/2			10 · 11 · 12 · 13 · 14 · 15 · 16 · 17 · 19 · 20 · 21 · 22 · 24 · 27 · 30 · 32 mm
4 x	6.3 1/4			3 · 4 · 5 · 6 mm
3 x	6.3 1/4			0.8x4 · 1x5.5 · 1.2x6.5 mm
3 x	6.3 1/4			PH1 · PH2 · PH3
3 x	6.3 1/4			PZ1 · PZ2 · PZ3
6 x	6.3 1/4			T10 · T15 · T20 · T25 · T30 · T40
1 x	-	6.3 1/4		150 mm
1 x	-	125 1/2		250 mm
9 x	-			1.5 · 2 · 2.5 · 3 · 4 · 5 · 6 · 8 · 10 mm
9 x	-			T10 · T15 · T20 · T25 · T27 · T30 · T40 · T45 · T50

Universal Werkzeugkoffer



V2542, EAN 4047728**025423**

Werkzeugkoffer · universal

• Werkzeug-Koffer inklusive Sortiment



VIGOR No.	Bezeichnung	EAN 4047728+
V2400	Koffer · leer	024006
V2464	Weichschaum-Einlage · leer	024648

Einzelteilaufistung ab Seite 120



Doppel-Maulschlüssel

- Sicherer Halt bei öligen Händen dank Anti-Rutsch-Oberfläche
- Oberfläche: mattverchromt
- DIN 3110

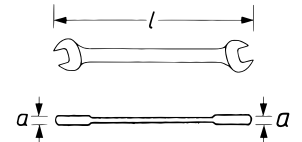

VIGOR No.	a mm	SW	l mm	EAN 4047728+	VIGOR No.	a mm	SW	l mm	EAN 4047728+
V1461N-6X7	3.4	6x7 mm	126	064903	V1461N-18X19	7.3	18x19 mm	220	064309
V1461N-8X9	3.6	8x9 mm	142	064187	V1461N-20X22	7.3	20x22 mm	232	064026
V1461N-10X11	4.5	10x11 mm	157	064200	V1461N-21X23	7.5	21x23 mm	246	064033
V1461N-12X13	5.1	12x13 mm	170	064231	V1461N-24X27	8.4	24x27 mm	265	064064
V1461N-14X15	5.4	14x15 mm	187	064262	V1461N-25X28	8.5	25x28 mm	275	064071
V1461N-16X17	6	16x17 mm	202	064286	V1461N-30X32	9.2	30x32 mm	298	064095

V1461N, EAN 4047728064934

Doppel-Maulschlüssel Satz

- Sicherer Halt bei öligen Händen dank Anti-Rutsch-Oberfläche
- Oberfläche: mattverchromt
- DIN 3110



xx	Ausführung	SW
12 x		6x7 · 8x9 · 10x11 · 12x13 · 14x15 · 16x17 · 18x19 · 20x22 · 21x23 · 24x27 · 25x28 · 30x32 mm



Ring-Maulschlüssel

- Lange Ausführung
- 15° gekröpfter Ringschlüssel
- Sicherer Halt bei öligen Händen dank Anti-Rutsch-Oberfläche
- Oberfläche: mattverchromt
- DIN 3113 Form A, ISO 7738

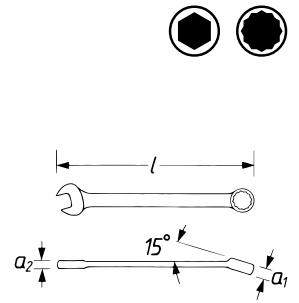

VIGOR No.	a1 mm	a2 mm	SW	l mm	EAN 4047728+	VIGOR No.	a1 mm	a2 mm	SW	l mm	EAN 4047728+
V4473N-6	4.8	3.4	6 mm	100	064439	V4473N-17	9.6	6.8	17 mm	210	064576
V4473N-7	5.4	3.5	7 mm	110	064446	V4473N-18	10.1	7.2	18 mm	220	064583
V4473N-8	5.5	3.8	8 mm	115	064453	V4473N-19	10.2	7.3	19 mm	230	064590
V4473N-9	6	4	9 mm	125	064460	V4473N-20	10.8	7.4	20 mm	240	064606
V4473N-10	6.3	4.5	10 mm	135	064477	V4473N-21	11.1	7.6	21 mm	245	064613
V4473N-11	6.8	4.9	11 mm	145	064484	V4473N-22	11.7	7.9	22 mm	248	064408
V4473N-12	7.2	5	12 mm	155	064491	V4473N-24	12.8	8.4	24 mm	270	064712
V4473N-13	8.3	5.6	13 mm	165	064507	V4473N-27	13.9	9.1	27 mm	300	064736
V4473N-14	8.5	5.7	14 mm	171	064514	V4473N-30	15.2	9.9	30 mm	330	064743
V4473N-15	9.2	6.1	15 mm	185	064323	V4473N-32	15.9	10.2	32 mm	350	064750
V4473N-16	9.3	6.5	16 mm	195	064569	V4473N-36	19.3	11.6	36 mm	400	064767

V4472N, EAN 4047728064958

Ring-Maulschlüssel Satz

- Lange Ausführung
- 15° gekröpfter Ringschlüssel
- Sicherer Halt bei öligen Händen dank Anti-Rutsch-Oberfläche
- Oberfläche: mattverchromt
- DIN 3113 Form A, ISO 7738



XX	Ausführung	SW
15 x		6 · 7 · 8 · 9 · 10 · 11 · 12 · 13 · 14 · 15 · 16 · 17 · 18 · 19 · 22 mm



V4473N, EAN 4047728064965

Ring-Maulschlüssel Satz

- Lange Ausführung
- 15° gekröpfter Ringschlüssel
- Sicherer Halt bei öligen Händen dank Anti-Rutsch-Oberfläche
- Oberfläche: mattverchromt
- DIN 3113 Form A, ISO 7738



XX	Ausführung	SW
22 x		6 · 7 · 8 · 9 · 10 · 11 · 12 · 13 · 14 · 15 · 16 · 17 · 18 · 19 · 20 · 21 · 22 · 24 · 27 · 30 · 32 · 36 mm



Doppel-Ringschlüssel

- 15° gekröpft
- Sicherer Halt bei öligen Händen dank Anti-Rutsch-Oberfläche
- Oberfläche: verchromt, poliert
- DIN 838, ISO 10104

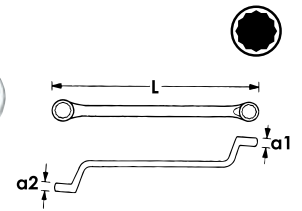

VIGOR No.	a1 mm	a2 mm	SW	L mm	EAN 4047728+	VIGOR No.	a1 mm	a2 mm	SW	L mm	EAN 4047728+
V1524N-6X7	5.8	5	6x7 mm	175	064774	V1524N-18X19	12.1	10.8	18x19 mm	268	064835
V1524N-8X9	7.7	6.7	8x9 mm	185	064781	V1524N-20X22	12.5	11.7	20x22 mm	292	064842
V1524N-10X11	8.4	7.4	10x11 mm	198	064798	V1524N-21X23	13.2	12.2	21x23 mm	315	064859
V1524N-12X13	8.4	9.1	12x13 mm	215	064804	V1524N-24X27	13.4	12.2	24x27 mm	328	064866
V1524N-14X15	10.4	9.5	14x15 mm	228	064811	V1524N-25X28	14.9	13.9	25x28 mm	342	064873
V1524N-16X17	10.8	10	16x17 mm	246	064828	V1524N-30X32	16	15.2	30x32 mm	370	064880

V1524N, EAN 4047728064910

Doppel-Ringschlüssel Satz

- 15° gekröpft
- Sicherer Halt bei öligen Händen dank Anti-Rutsch-Oberfläche
- Oberfläche: verchromt, poliert
- DIN 838, ISO 10104



xx	Ausführung	SW
12 x		6x7 · 8x9 · 10x11 · 12x13 · 14x15 · 16x17 · 18x19 · 20x22 · 21x23 · 24x27 · 25x28 · 30x32 mm

Ratschen-Ring-Maulschlüssel · kurz

- 72 Zähne
- 5° Betätigungswinkel

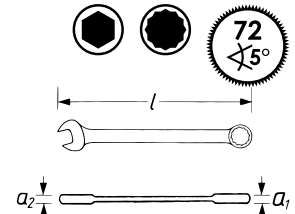

VIGOR No.	a1 mm	a2 mm	SW	L mm	EAN 4047728+	VIGOR No.	a1 mm	a2 mm	SW	L mm	EAN 4047728+
V2822	7.4	4.9	8 mm	89	028226	V2828	8.4	7	14 mm	114	028288
V2823	7.5	5.2	9 mm	93	028233	V2829	8.4	7.4	15 mm	120	028295
V2824	8.5	5.5	10 mm	97	028240	V2830	10	7.7	16 mm	122	028301
V2825	8.4	6.1	11 mm	102	028257	V2831	10	7.7	17 mm	126	028318
V2826	8.5	6.3	12 mm	106	028264	V2832	11.5	8.4	18 mm	131	028325
V2827	8.4	6.7	13 mm	110	028271	V2833	11.5	8.6	19 mm	136	028332

V2821, EAN 4047728028219

Ratschen-Ring-Maulschlüssel Satz · kurz

- Lieferung in Rolltasche
- 72 Zähne
- 5° Betätigungswinkel



xx	Ausführung	SW
12 x		8 · 9 · 10 · 11 · 12 · 13 · 14 · 15 · 16 · 17 · 18 · 19 mm

Ratschen-Ring-Maulschlüssel · lang

- Oberfläche: verchromt, poliert
- 72 Zähne
- 5° Betätigungswinkel

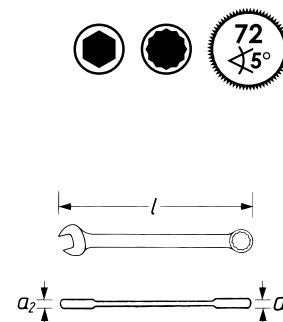

VIGOR No.	a1 mm	a mm	SW	L mm	EAN 4047728+
V3635	7.4	4.6	6 mm	135	036351
V3636	7.4	4.7	7 mm	144	036368
V1008	7.4	4.7	8 mm	140	010085
V1009	7.4	5.3	9 mm	151	010092
V1010	8.4	5.7	10 mm	160	010108
V1021	8.4	6.1	11 mm	165	010214
V1022	8.4	6.4	12 mm	170	010221
V1023	8.4	6.6	13 mm	177	010238
V1025	8.4	7.3	14 mm	192	010252
V1026	8.4	7.5	15 mm	200	010269

VIGOR No.	a1 mm	a mm	SW	L mm	EAN 4047728+
V1027	10	7.7	16 mm	210	010276
V1028	10	7.9	17 mm	225	010283
V1029	11.5	8.4	18 mm	235	010290
V1030	11.5	8.7	19 mm	245	010306
V4961	12.5	9	21 mm	275	049610
V4962	13.5	10	22 mm	285	049627
V4963	13.5	11	24 mm	296	049634
V4964	13.5	12	27 mm	340	049641
V4965	16	13	30 mm	369	049658
V4966	16	14	32 mm	395	049665

V1031, EAN 4047728010313

Ratschen-Ring-Maulschlüssel Satz · lang

- Rolltasche
- Oberfläche: verchromt, poliert
- 72 Zähne
- 5° Betätigungswinkel



xx	Ausführung	SW
12 x		8 · 9 · 10 · 11 · 12 · 13 · 14 · 15 · 16 · 17 · 18 · 19 mm



V2820, EAN 4047728028202

Ratschen-Ring-Maulschlüssel Satz · lang

- Rolltasche
- Oberfläche: verchromt, poliert
- 72 Zähne
- 5° Betätigungswinkel



xx	Ausführung	SW
5 x		8 · 10 · 13 · 17 · 19 mm



Doppelgelenk Ratschen-Ring-Maulschlüssel

- Ratschenkopf mit Doppelgelenk
- Doppelsechskant Profil im Ring
- 72 Zähne
- 5° Betätigungswinkel

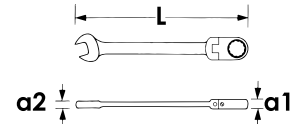
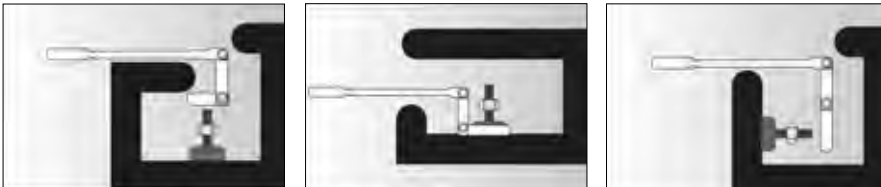
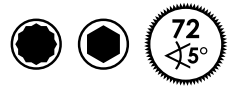

VIGOR No.	a1 mm	a2 mm	SW	L mm	EAN 4047728+	VIGOR No.	a1 mm	a2 mm	SW	L mm	EAN 4047728+
V6752-8	7.4	4.7	8 mm	163	067522	V6752-14	8.4	7.3	14 mm	217	067881
V6752-9	7.4	5.3	9 mm	168	067836	V6752-15	8.4	7.5	15 mm	228	067898
V6752-10	8.4	5.7	10 mm	178	067843	V6752-16	10	7.7	16 mm	245	067904
V6752-11	8.4	6.1	11 mm	186	067850	V6752-17	10	7.9	17 mm	259	068017
V6752-12	8.4	6.4	12 mm	196	067867	V6752-18	11.5	8.4	18 mm	273	068024
V6752-13	8.4	6.6	13 mm	206	067874	V6752-19	11.5	8.7	19 mm	285	068031

V6752/12, EAN 4047728068048

Doppelgelenk Ratschen-Ring-Maulschlüssel Satz

- Ratschenkopf mit Doppelgelenk
- Doppelsechskant Profil im Ring
- In Rolltasche
- 72 Zähne
- 5° Betätigungswinkel



xx	Ausführung	SW
12 x		8 · 9 · 10 · 11 · 12 · 13 · 14 · 15 · 16 · 17 · 18 · 19 mm



Gelenk Ratschen-Ring-Maulschlüssel

- 72 Zähne
- 5° Betätigungswinkel

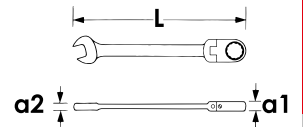
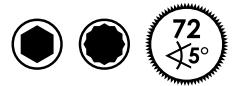

VIGOR No.	a1 mm	a2 mm	SW	L mm	EAN 4047728+
V2804	7.4	5	8 mm	143	028042
V2805	7.4	5.3	9 mm	150	028059
V2806	8.4	5.9	10 mm	158	028066
V2807	8.4	6.1	11 mm	165	028073
V2808	8.4	6.4	12 mm	170	028080
V2809	8.4	6.7	13 mm	182	028097

VIGOR No.	a1 mm	a2 mm	SW	L mm	EAN 4047728+
V2810	8.4	7.4	14 mm	190	028103
V2811	8.5	7.6	15 mm	200	028110
V2812	9.9	7.6	16 mm	215	028127
V2813	10	8	17 mm	228	028134
V2814	11.1	8.2	18 mm	241	028141
V2817	11.5	8.7	19 mm	250	028172

V6752/5, EAN 4047728072113

Doppelgelenk Ratschen-Ring-Maulschlüssel Satz

- Ratschenkopf mit Doppelgelenk
- Doppelsechskant Profil im Ring
- 72 Zähne
- 5° Betätigungswinkel



xx	Ausführung	SW
5 x		8 · 10 · 13 · 17 · 19 mm



V2818, EAN 4047728028189

Gelenk Ratschen-Ring-Maulschlüssel Satz

- Rolltasche
- Oberfläche: verchromt, poliert
- 72 Zähne
- 5° Betätigungswinkel



xx	Ausführung	SW
12 x		8 · 9 · 10 · 11 · 12 · 13 · 14 · 15 · 16 · 17 · 18 · 19 mm



V3607, EAN 4047728**036078**

Doppel Ratschen-Ringschlüssel

- 72 Zähne
- 5° Betätigungswinkel



Multiprofil



10 mm

4 in 1

13 mm



8 mm

12 mm

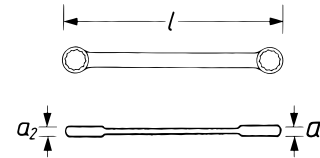

VIGOR No.	α_1 mm	α_2 mm	SW	l mm	EAN 4047728+
V3607	12.5	14.5	8x12 · 10x13	220	036078



V2705, EAN 4047728**027052**

Doppel Ratschen-Ringschlüssel

- 72 Zähne
- 5° Betätigungswinkel



Doppel-Sechskant



17 mm

4 in 1

19 mm

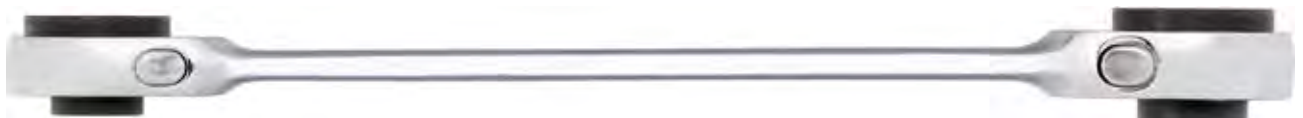

10 mm

13 mm

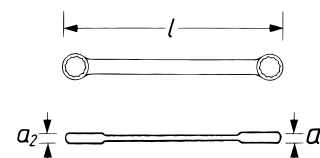

VIGOR No.	α_1 mm	α_2 mm	SW	l mm	EAN 4047728+
V2705	20	17	10x13 · 17x19	220	027052

Doppel Ratschen-Ringschlüssel

- Oberfläche: hochglanzverchromt
- 72 Zähne
- 5° Betätigungswinkel



VIGOR No.	SW	EAN 4047728+
V6611-6X8	E6, E8	073578
V6611-10X12	E10, E12	073585
V6611-14X18	E14, E18	073592
V6611-20X24	E20, E24	073608

V6611/4, EAN 4047728073561

Doppel Ratschen-Ringschlüssel Satz

- Rolltasche
- Oberfläche: hochglanzverchromt
- 72 Zähne
- 5° Betätigungswinkel



xx	Ausführung	SW
1 x		E6, E8
1 x		E10, E12
1 x		E14, E18
1 x		E20, E24



Rollgabelschlüssel

- Einhandverstellung der Schlüsselweite durch Verstellrad am Schlüsselkopf
- Maulstellung 15° abgewinkelt
- Gut lesbare mm-Skala am Schlüsselkopf

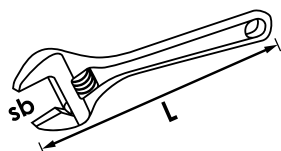

mm-Skala am Schlüsselkopf

Aufhängeloch



VIGOR No.	L mm	sb mm	EAN 4047728+
V6048	150	24	069625
V6049	250	33	069618



V1208, EAN 4047728012089

Schraubendreher · kurz

• 5,5x38 mm



V1209, EAN 4047728012096

Schraubendreher · kurz

• PH 2x38 mm



Schlitz-Schraubendreher

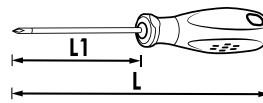

VIGOR No.	SW	L1 mm	L mm	EAN 4047728+
V1698	0.6x3 mm	75	156	016988
V1699	0.8x4 mm	80	161	016995
V1700	1x5.5 mm	125	231	017008
V1701	1.2x6.5 mm	150	256	017015
V3613	1.6x8 mm	150	266	036139
V3609	1.6x10 mm	175	291	036092

Kreuzschlitz-Schraubendreher

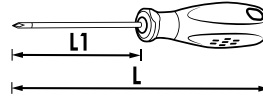

VIGOR No.	SW	L1 mm	L mm	EAN 4047728+
V1702	PH0	75	156	017022
V1703	PH1	80	186	017039
V1704	PH2	100	206	017046
V3610	PH3	150	266	036108

Schlitz-Schraubendreher mit Schlagkappe

• Nach DIN/ISO gefertigt

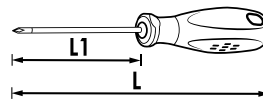

VIGOR No.	SW	L1 mm	L mm	EAN 4047728+
V3597	0.6x3.5 mm	75	157	035972
V3598	1x4.5 mm	100	182	035989
V3599	1x5.5 mm	100	207	035996
V3600	1.2x6.5 mm	125	232	036009
V5042	1.6x8 mm	150	267	050425
V5043	1.6x10 mm	175	297	050432
V5044	2x12 mm	200	317	050449

Kreuzschlitz-Schraubendreher mit Schlagkappe

• Nach DIN/ISO gefertigt

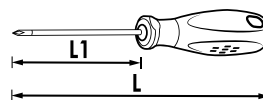

VIGOR No.	SW	L1 mm	L mm	EAN 4047728+
V3601	PH1	182	75	036016
V3602	PH2	207	100	036023
V4667	PH3	200	315	046671

V4655, EAN 4047728**046558**

Schraubendreher Satz

• Nach DIN/ISO gefertigt



XX		Ausführung	SW
1 x	⊖		1 x 5.5 mm
5 x	⊖		0.6 x 3 · 0.8 x 4 · 1 x 5.5 · 1.6 x 8 · 1.6 x 10 mm
1 x	⊕		PH2
4 x	⊕		PH0 · PH1 · PH2 · PH3



V1637, EAN 4047728**016377**

Schraubendreher Satz

• Nach DIN/ISO gefertigt



XX		Ausführung	SW
4 x	⊖		0.6 x 3 · 0.8 x 4 · 1 x 5.5 · 1.2 x 6.5 mm
3 x	⊕		PH0 · PH1 · PH2



V3562, EAN 4047728**035620**

Schraubendreher Satz mit Schlagkappe

• Nach DIN/ISO gefertigt



Mit Schlagkappe

6-kant

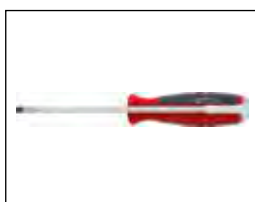

XX		Ausführung	SW
4 x	⊖		0.6 x 3.5 · 1 x 4.5 · 1 x 5.5 · 1.2 x 6.5 mm
2 x	⊕		PH1 · PH2



V4432/6, EAN 4047728073868

Schraubendreher Satz · extra lang

• Arbeiten an schwer zugänglichen Stellen



710 mm Gesamtlänge
600 mm Klingenlänge

VIGOR No.	Bezeichnung	Ausführung		SW	mm	EAN 4047728+
V4436	Schlitz-Schraubendreher · extra lang		⊖	1.2 x 6 mm	600	073905
V4437	Schlitz-Schraubendreher · extra lang		⊖	1.6 x 8 mm	600	073912
V4438	Schlitz-Schraubendreher · extra lang		⊖	1.6 x 10 mm	600	073929
V4433	Kreuzschlitz-Schraubendreher · extra lang		⊕	PH1	600	073875
V4434	Kreuzschlitz-Schraubendreher · extra lang		⊕	PH2	600	073882
V4435	Kreuzschlitz-Schraubendreher · extra lang		⊕	PH3	600	073899



V7124, EAN 4047728071246

Schlag-Schraubendreher Satz

- Betätigen von stark korrodierten Verschraubungen, z.B. Zentrierschrauben bei Bremsscheiben
- Durch Hammerschlag wird am Schraubendreher-Abtrieb eine Vierteldrehung in Löserichtung getätigt
- Umstellen der Modi durch Drehen des Einstellrads in 2 Schritten: Standard-Modus und Schlagfunktion



VIGOR No.	Bezeichnung	Ausführung		SW	mm	EAN 4047728+
V7124-PH1	Schlag-Schraubendreher		⊕	PH1	160	071253
V7124-PH2	Schlag-Schraubendreher		⊕	PH2	185	071260
V7124-PH3	Schlag-Schraubendreher		⊕	PH3	210	071277
V7124-PZ1	Schlag-Schraubendreher		⊕	PZ1	185	071284
V7124-PZ2	Schlag-Schraubendreher		⊕	PZ2	185	071291
V7124-T20	Schlag-Schraubendreher		⊕	T20	160	071307
V7124-T25	Schlag-Schraubendreher		⊕	T25	185	071413
V7124-T30	Schlag-Schraubendreher		⊕	T30	210	071420



T Schraubendreher

• Nach DIN/ISO gefertigt

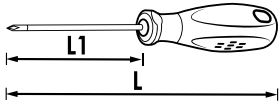

VIGOR No.	SW	L1 mm	mm	EAN 4047728+
V4419	T6	74	154	044196
V4420	T7	74	154	044202
V4421	T8	74	154	044219
V4422	T9	74	154	044226
V3367	T10	100	206	033671
V3368	T15	100	206	033688
V3369	T20	100	206	033695
V3370	T25	100	206	033701
V3391	T27	100	206	033916
V3392	T30	100	206	033923
V3393	T40	100	206	033930



V4418, EAN 4047728044189

T Schraubendreher Satz

• Nach DIN/ISO gefertigt



xx	Ausführung	SW
4 x	T6 · T7 · T8 · T9	



V3366, EAN 4047728033664

T Schraubendreher Satz

• Nach DIN/ISO gefertigt



xx	Ausführung	SW
7 x	T10 · T15 · T20 · T25 · T27 · T30 · T40	



Schraubendreher · flexibel

- Schlauchschellen an Kühlwasserschläuchen
- Arbeiten auch in engen Bereichen, die mit einem herkömmlichen Schraubendreher nicht erreichbar wären
- Ausführung mit doppelter Spiralfeder inklusive Kunststoff-Ummantelung

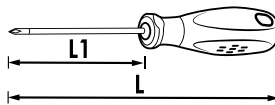

VIGOR No.	SW	L	EAN
		mm	4047728+
V4664	6 mm	300	046640
V4665	7 mm	300	046657
V4666	8 mm	300	046664

V5661, EAN 4047728056618

Schraubendreher Satz · flexibel

- Schlauchschellen an Kühlwasserschläuchen
- Arbeiten auch in engen Bereichen, die mit einem herkömmlichen Schraubendreher nicht erreichbar wären
- Ausführung mit doppelter Spiralfeder inklusive Kunststoff-Ummantelung



XX	Ausführung	SW
3 x		6 · 7 · 8 mm

V5485N, EAN 4047728060714

Schraubendreher Satz · extra lang · flexibel

- Arbeiten an schwer zugänglichen Stellen
- Extralang, Länge: 500 mm
- Universelle 6,3 mm (1/4") Bit-Aufnahme
- Universeller 6,3 mm (1/4") Vierkant
- 7 mm Sechskant Abtrieb



XX	Bit	Bit	Ausführung	SW
6 x	6.3 1/4			T10 · T15 · T20 · T25 · T27 · T30
2 x	6.3 1/4			PH1 · PH2
2 x	6.3 1/4			1 x 5.5 · 1.2 x 6.5 mm
1 x	-	6.3 1/4		500 mm
1 x	-	6.3 1/4		500 mm
1 x	-			7 mm
5 x	6.3 1/4			5 · 6 · 7 · 8 · 10 mm

V5601, EAN 4047728**056014**

Winkelschraubendreher Satz

- Im Clip
- Lange Ausführung
- Kugelkopf
- Inhalt: 1,5 · 2 · 2,5 · 3 · 4 · 5 · 6 · 7 · 8 · 10 mm



Inklusive SW 7 mm



V4942, EAN 4047728**049429**

Winkelschraubendreher Satz

- Im Clip
- Lange Ausführung
- Kugelkopf
- Inhalt: 1,5 · 2 · 2,5 · 3 · 4 · 5 · 6 · 8 · 10 mm



V4708, EAN 4047728**047081**

T Winkelschraubendreher Satz

- Im Clip
- Lange Ausführung
- Kugelkopf
- Inhalt: T10 · T15 · T20 · T25 · T27 · T30 · T40 · T45 · T50



Winkelschraubendreher



VIGOR No.	SW	mm	EAN 4047728+
V2448N	1.3 mm	40	058070
V2450N	2 mm	48	058094

V4303, EAN 4047728**043038**

Elektronik-Schraubendreher Satz

- Drehbares Kopfteil und Schnelldreh-Zone
- Vier Schraubendreher für Schlitzschrauben 1.6 · 2 · 2.4 · 3 mm
- Zwei Schraubendreher für Kreuzschlitzschrauben PH00 · PH0
- In Kunststoff-Box



XX	Ausführung	SW
4 x		1.6 · 2 · 2.4 · 3
2 x		PH0 · PH00

Sechskant T-Griff Schraubendreher

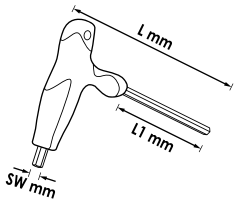

VIGOR No.	SW	L1 mm	L mm	EAN 4047728+
V2489	2 mm	100	160	024891
V2486	2.5 mm	100	160	024860
V2507	3 mm	100	160	025072
V2506	4 mm	100	160	025065
V2505	5 mm	100	160	025058
V2504	6 mm	132	217	025041
V2503	8 mm	132	217	025034
V2502	10 mm	132	217	025027



V1409, EAN 4047728**014090**

Sechskant T-Griff Schraubendreher Satz

- Inklusive Halter



Inklusive



XX	Ausführung	SW
8 x		2 · 2.5 · 3 · 4 · 5 · 6 · 8 · 10 mm

T-Griff Schraubendreher

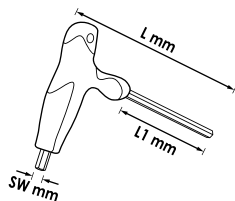

VIGOR No.	SW	L1 mm	L mm	EAN 4047728+
V2498	T9	100	160	024983
V2497	T10	100	160	024976
V2501	T15	100	160	025010
V2490	T20	100	160	024907
V2485	T25	100	160	024853
V2484	T27	132	217	024846
V2483	T30	132	217	024839
V2482	T40	132	217	024822



V1410, EAN 4047728014106

T-Griff Schraubendreher Satz



Inklusive



xx	Ausführung	SW
8 x		T9 · T10 · T15 · T20 · T25 · T27 · T30 · T40



Bit Schraubendreher



VIGOR No.	L mm	EAN 4047728+
V3427N	200	058865



Sechskant Steckschlüssel-Schraubendreher

• Oberfläche: verchromt

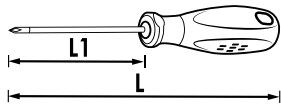

VIGOR No.	SW	L1 mm	EAN 4047728+
V4200	6 mm	150	042000
V4221	7 mm	150	042215
V4222	8 mm	150	042222
V4223	10 mm	150	042239
V4224	12 mm	150	042246
V4225	13 mm	150	042253



V4199, EAN 4047728041997

Sechskant Steckschlüssel-Schraubendreher Satz

• Oberfläche: verchromt



XX	Ausführung	SW
6 x		6 · 7 · 8 · 10 · 12 · 13 mm



V7784, EAN 4047728**077842**

Ratschenschlüssel Bit Satz

- Gute Erreichbarkeit von schwer zugänglichen Stellen: Bits werden in die Ratsche eingetaucht → Ratschenkopfhöhe sehr gering
- Bit Sortiment mit 10 mm Sechskant Aufnahme
- 2 Aufnahmen:
Starre Seite zum Lösen von festsitzenden Verschraubungen
Bit Ratschen-Aufnahme mit Feinverzahnung von 72 Zähnen
- Länge Ratschen Schlüssel: 250 mm

10 3/8"



NEU



XX	■		SW
9 x	10 3/8"	☼	T10 · T15 · T20 · T25 · T27 · T30 · T40 · T45 · T50
10 x	10 3/8"	☼	T10H · T15H · T20H · T25H · T27H · T30H · T40H · T45H · T50H · T55H
6 x	10 3/8"	○	4 · 5 · 6 · 7 · 8 · 10 mm
6 x	10 3/8"	○	M4 · M5 · M6 · M8 · M10 · M12
5 x	10 3/8"	☼	M5 · M6 · M7 · M8 · M10



V5650, EAN 4047728**056502**

Seitenschneider mit Doppelgelenk

- Extrem schmale Ausführung
- Für schwer zugängliche Bereiche

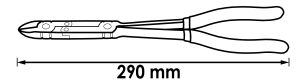

V2781, EAN 4047728**027816**

Kombizange mit Doppelgelenk

- Gezahnte, extrem schmale Ausführung
- Für schwer zugängliche Bereiche

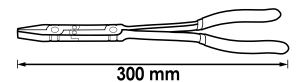
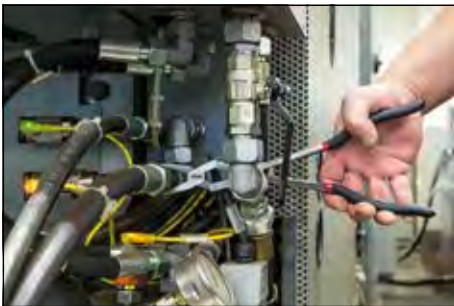

V2782, EAN 4047728**027823**

Flachrund-Zange mit Doppelgelenk

- Gezahnte, extrem schmale Ausführung
- Für schwer zugängliche Bereiche

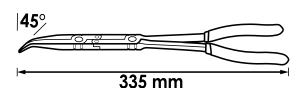

V2783, EAN 4047728027830

Flachrund-Zange mit Doppelgelenk

- Gezahnte, extrem schmale Ausführung
- Für schwer zugängliche Bereiche

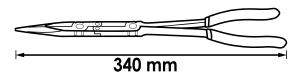

V5493, EAN 4047728054935

Zündkerzenzange mit Doppelgelenk

- Aufstecken und Abziehen von schwer erreichbaren Zündkerzensteckern
- Auch zum Trennen von Kraftstoffleitung-Verbindungen
- 45° abgewinkelter Kopf

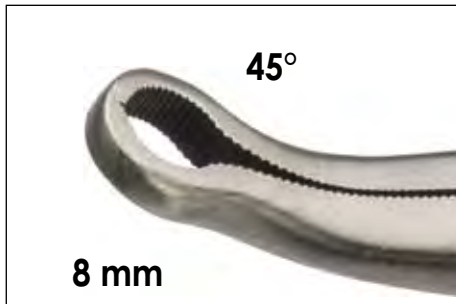

Sichere Handhabung durch eingearbeitete Verzahnung

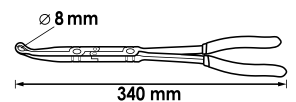

V5494, EAN 4047728054942

Zündkerzenzange mit Doppelgelenk

- Aufstecken und Abziehen von schwer erreichbaren Zündkerzensteckern
- Auch zum Trennen von Kraftstoffleitung-Verbindungen
- 45° abgewinkelter Kopf

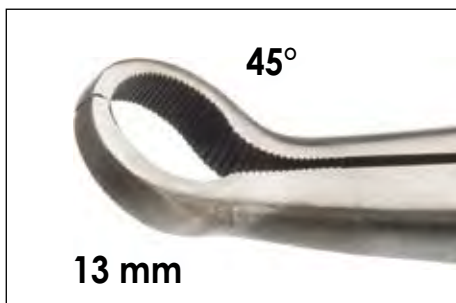

Sichere Handhabung durch eingearbeitete Verzahnung

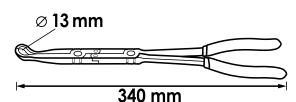

V5496, EAN 4047728054966

Sicherungsring-Zange mit Doppelgelenk · Innensicherung

- Innensicherungen (Bohrungen) 8 – 30 mm Ø
- Besonders einfacher Wechsel der Spitzen
- Spitzen farblich codiert
- Ausführung Spitzen / Inhalt:
 - 2x Ø 1,0 mm gerade
 - 2x Ø 1,0 mm 90° abgewinkelt
 - 2x Ø 1,3 mm gerade
 - 2x Ø 1,3 mm 90° abgewinkelt
 - 2x Ø 1,8 mm gerade
 - 1 x Innensechskant-Schlüssel



Doppelgelenk überträgt bereits kleinste Griffbewegungen exponentiell verstärkt an die Spitzen



V5496-1, EAN 4047728054980

Ersatzspitzen Satz für Sicherungsring-Zange mit Doppelgelenk

- Sicherungsringzangen mit Doppelgelenk V5496 · V5497
- Inhalt:
 - 2x Ø 1,0 mm · gerade
 - 2x Ø 1,0 mm · 90° abgewinkelt
 - 2x Ø 1,3 mm · gerade
 - 2x Ø 1,3 mm · 90° abgewinkelt
 - 2x Ø 1,8 mm · gerade
 - 1 x Innensechskant-Schlüssel



V5497, EAN 4047728054973

Sicherungsring-Zange mit Doppelgelenk · Außensicherung

- Außensicherungen (Wellen) 12 – 30 mm Ø
- Besonders einfacher Wechsel der Spitzen
- Spitzen farblich codiert
- Ausführung Spitzen / Inhalt:
 - 2x Ø 1,0 mm gerade
 - 2x Ø 1,0 mm 90° abgewinkelt
 - 2x Ø 1,3 mm gerade
 - 2x Ø 1,3 mm 90° abgewinkelt
 - 2x Ø 1,8 mm gerade
 - 1 x Innensechskant-Schlüssel



Doppelgelenk überträgt bereits kleinste Griffbewegungen exponentiell verstärkt an die Spitzen



Zangen



V6510-10/4, EAN 4047728**076951**

Sicherungsring-Zangen
Satz · 140 mm



NEU

V6510A-10
V6510B-10
V6510C-12
V6510D-12



V6510-19/4, EAN 4047728**076968**

Sicherungsring-Zangen
Satz · 180 mm



NEU

V6510A-19
V6510B-19
V6510C-19
V6510D-19



Sicherungsring-Zange



NEU

VIGOR No.	● mm	≡ mm	↔ mm	EAN 4047728+
V6510A-10	10-25 mm	1.3	140	076807

Sicherungsring-Zange



NEU

VIGOR No.	● mm	≡ mm	↔ mm	EAN 4047728+
V6510A-19	19-60 mm	1.8	180	076814



Sicherungsring-Zange

NEU



VIGOR No.	mm	mm	mm	EAN 4047728+
V6510A-40	40-100 mm	2.3	230	076821

Sicherungsring-Zange

NEU



VIGOR No.	mm	mm	mm	EAN 4047728+
V6510B-10	10-25 mm	1.3	140	076838

Sicherungsring-Zange

NEU



VIGOR No.	mm	mm	mm	EAN 4047728+
V6510B-19	19-60 mm	1.8	180	076845

Sicherungsring-Zange

NEU



VIGOR No.	mm	mm	mm	EAN 4047728+
V6510B-40	40-100 mm	2.3	230	076852

Sicherungsring-Zange



NEU

VIGOR No.	mm	mm	mm	EAN 4047728+
V6510C-12	12-25 mm	1.3	140	076869

Sicherungsring-Zange



NEU

VIGOR No.	mm	mm	mm	EAN 4047728+
V6510C-19	19-60 mm	1.8	180	076876

Sicherungsring-Zange



NEU

VIGOR No.	mm	mm	mm	EAN 4047728+
V6510C-40	40-100 mm	2.3	230	076883

Sicherungsring-Zange



NEU

VIGOR No.	mm	mm	mm	EAN 4047728+
V6510D-12	12-25 mm	1.3	140	077248



Sicherungsring-Zange

NEU



VIGOR No.	mm	mm	mm	EAN
V6510D-19	19-60 mm	1.8	180	4047728+ 076906

Sicherungsring-Zange

NEU



VIGOR No.	mm	mm	mm	EAN
V6510D-40	40-100 mm	2.3	230	4047728+ 076913

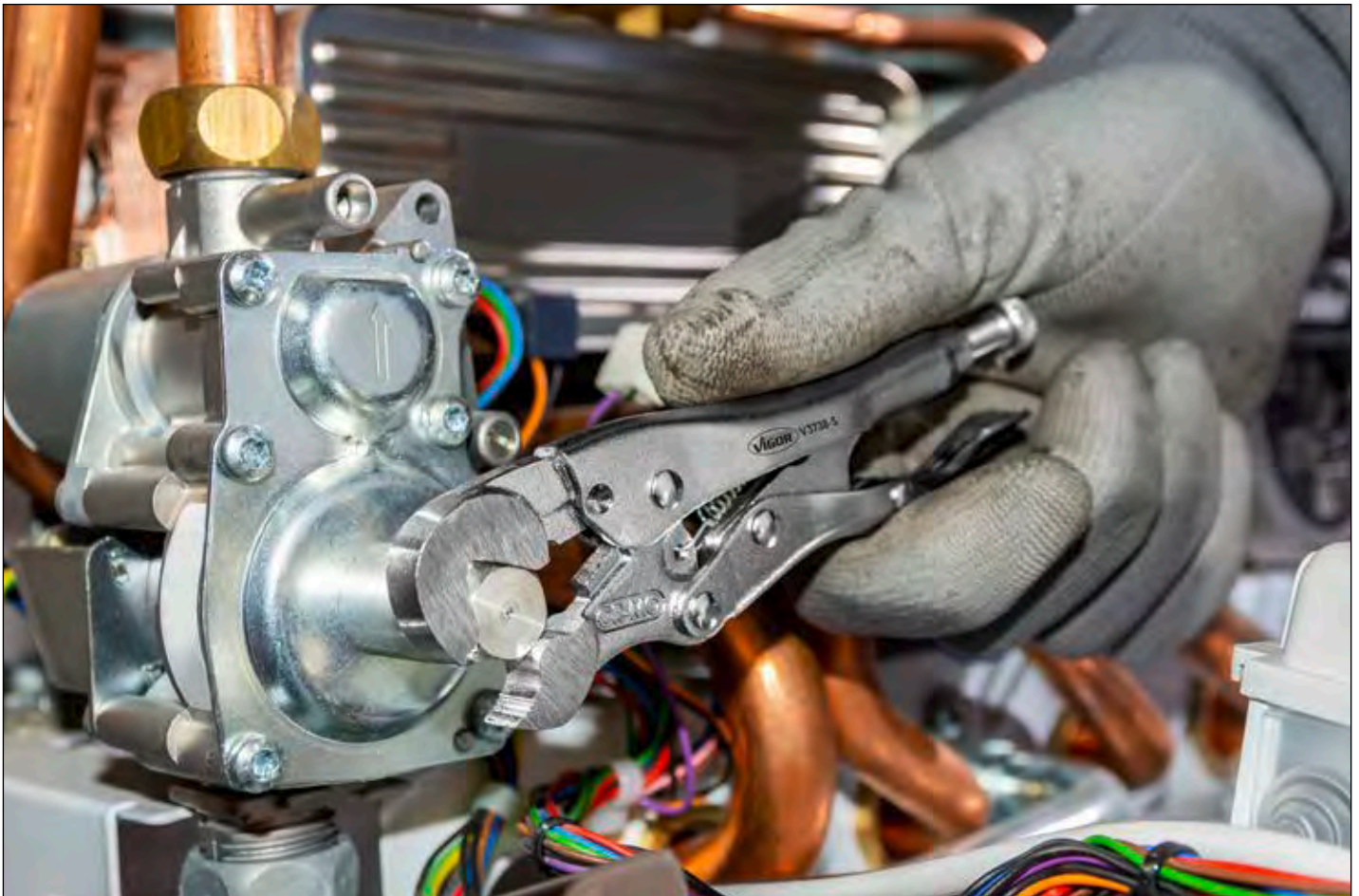

Maul-Gripzange

- Sicheres Greifen von Muttern oder Schraubenköpfen
- Größenverstellung durch Justierschraube
- Feststell-Arretierung am Griff
- Verzahnte Maulinnenfläche
- Ergonomisch geformt, einfache Handhabung
- Chrom-Molybdän
- Vernickelt

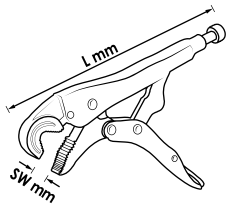

VIGOR No.	SW	L mm	EAN 4047728+
V3738-S	6 – 13 mm	100	069540
V3738	11 – 19 mm	175	037389
V3739	16 – 27 mm	250	037396

Drahtschneider



V1808, EAN 4047728018081

Gripzangen Satz

- Größenverstellung durch Justierschraube
- Feststell-Arretierung am Griff
- Verzahnte Maulinnenfläche
- Ergonomisch geformt, einfache Handhabung
- Chrom-Molybdän
- Vernickelt



Lieferung in praktischer Rolltasche



VIGOR No.	Bezeichnung	Ausführung	L mm	EAN 4047728+
V1802	Maul-Gripzange		150	018029
V1803	Maul-Gripzange		250	018036
V1804	Maul-Gripzange		125	018043



V4637N, EAN 4047728**075565**

Schlauch- und Federbandschellen-Zange

- Betätigung von schwer erreichbaren, selbstspannenden Schlauch- und Federbandschellen
- Bowdenzug-Arretierung zum vorübergehenden Halten der Schelle
- Einfaches Lösen der Arretierung durch innenliegende Feder
- Ermüdungsfreies Arbeiten durch innenliegende Feder im Handgriff
- Gesamtlänge Bowdenzug: 590 mm
- Spannbereich: 18-53 mm



V4737, EAN 4047728**075572**

Kraftstoffleitungs-Zange

- Betätigen von schwer erreichbaren Kraftstoffleitungs-Kupplungen
- Flexibler Bowdenzug
- Kein Beschädigen der Kupplungen und Schläuche durch fachgerechtes Betätigen der Schnellverschlüsse
- Bowdenzug-Arretierung ermöglicht präzises Einstellen der Spanne
- Einfaches Lösen der Arretierung durch innenliegende Feder
- Gesamtlänge Bowdenzug: 590 mm
- Öffnungsweite: 30 mm



V4641, EAN 4047728**075558**

Spannschellen-Zange

- Betätigung von stufen- und ohrlosen Spannschellen an Achsmanschetten (auch Thermoplast-Achsmanschetten)
- Präzises Anziehen durch gleichmäßiges Zusammendrücken



Zangen



V4196, EAN 4047728**041966**
Zange für Kunststoffnieten



Inklusive 40 Kunststoffnieten

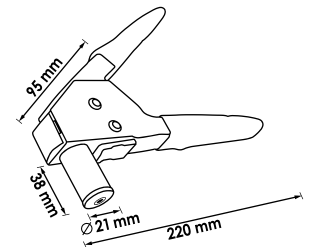

V6799, EAN 4047728**067997**
Abklemmzangen Satz

- Abklemmen von flexiblen Schlauchleitungen
- Sichere, verstellbare Arretierung
- Wartungsarbeiten mit Benzin, Kühlerfrostschutzmittel, Öl etc.
- Temperaturbeständigkeit bis 220° C

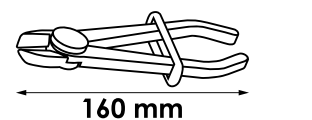
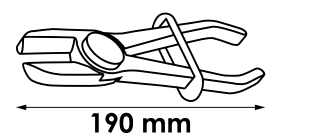
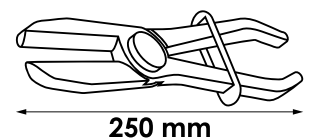

V3735, EAN 4047728**037358**

Nietzange für Blindnieten und Nietmuttern · universal

- Nietmutter: M 5 · M 6 · M 8 · M 10 für Kupfer-, Messing-, Stahl- und Edelstahlnieten
- Blindnieten: 3,2 · 4,0 · 4,8 · 6,4 mm für Kupfer-, Messing-, Stahl- und Edelstahlnieten



Ersatzteile

VIGOR No.	Bezeichnung	EAN 4047728+
V3735-3.2	Mundstück für Blindnieten · 3,2 mm	053976
V3735-4.0	Mundstück für Blindnieten · 4,0 mm	053617
V3735-4.8	Mundstück für Blindnieten · 4,8 mm	053624
V3735-6.4	Mundstück für Blindnieten · 6,4 mm	053631
V3735-M5	Mundstück für Nietmuttern · M 5	053495
V3735-M6	Mundstück für Nietmuttern · M 6	053501
V3735-M8	Mundstück für Nietmuttern · M 8	053518
V3735-M10	Mundstück für Nietmuttern · M 10	053525

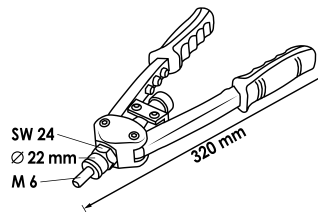

V2788, EAN 4047728**027885**

Blindniet-Zange

- Für Blindnieten: 3,2 · 4,0 · 4,8 · 6,4 mm
- Für Kupfer-, Messing-, Stahl- und Edelstahlnieten
- Sehr geringer Kraftaufwand bei extrem kurzer Bauform



Ersatzteile

VIGOR No.	Bezeichnung	EAN 4047728+
V2788-3.2	Mundstück für Blindnieten · 3,2 mm	053648
V2788-4.0	Mundstück für Blindnieten · 4,0 mm	053655
V2788-4.8	Mundstück für Blindnieten · 4,8 mm	053662
V2788-6.4	Mundstück für Blindnieten · 6,4 mm	053679

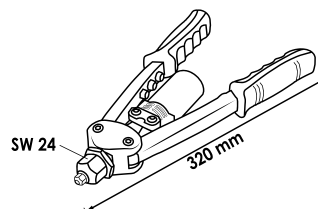

Zangen



V6500-140, EAN 4047728**076753**
Seitenschneider



NEU



V6500-160, EAN 4047728**076746**
Seitenschneider



NEU



V6501-180, EAN 4047728**076760**
Kombizange



NEU



V6502-200, EAN 4047728**076777**
Flachrund-Zange



NEU



V6503-200, EAN 4047728**076791**
Flachrund-Zange · abgewinkelt



NEU



V5639, EAN 4047728075589

Rohrzange

- Robuster Zangenkörper aus Gusseisen ermöglicht hohe Kraftübertragung
- Schnelles Verkanten und Lösen am Werkstück durch innenliegende Feder
- Grobe Backenverzahnung für optimalen Halt
- Maulöffnung: bis 60 mm
- Kapazität für Rohre: \varnothing 50 mm · 2"



NEU



V6504-250, EAN 4047728077750

Universalzange · mit Druckknopf

- – Wasserpumpenzange –
- Einstellung der Maulöffnung per Knopfdruck
- Einrasten des Gelenkbolzens verhindert unabsichtliches Verstellen
- Maulöffnung: bis 65 mm
- Kapazität für Muttern · sw 46 mm
- Kapazität für Rohre \varnothing 50 mm · \varnothing 2"
- Einstellpositionen: 23



NEU



V5681, EAN 4047728056816

Elektronik-Seitenschneider

- Für Drahtklassen:
 - Weich bis \varnothing 1,6 mm
 - Mittelhart bis \varnothing 1,2 mm
 - Hart bis \varnothing 0,8 mm

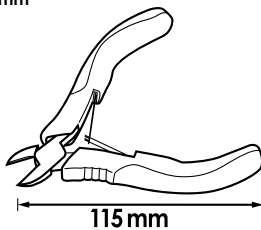

2/K



V1426N, EAN 4047728064392

Universalzange

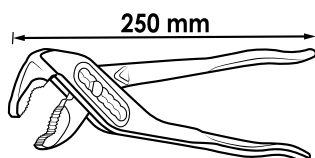

V3343, EAN 4047728**033435**

VDE Steckschlüssel Satz

- VDE isoliert bis 1000 V nach DIN EN 60900
- IEC 60900:2018
- Für Handbetätigung

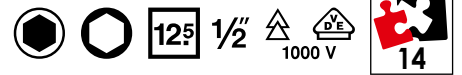

XX	■		Ausführung	SW
9 x	12.5 1/2	●		8 · 10 · 12 · 13 · 14 · 17 · 19 · 22 · 24 mm
3 x	12.5 1/2	○		5 · 6 · 8 mm
1 x	12.5 1/2	12.5 1/2		125 mm
1 x	-	12.5 1/2		255 mm



VDE Umschaltknarre

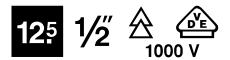

VIGOR No.	← L → mm	EAN 4047728+
V3342	255	033428

VDE Verlängerung

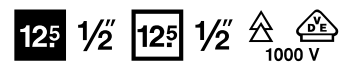

VIGOR No.	← L → mm	EAN 4047728+
V3341	125	033411



VDE Steckschlüsseinsatz

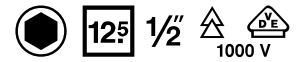

VIGOR No.	SW	L mm	EAN 4047728+
V3330	8 mm	55	033305
V3331	10 mm	55	033312
V3332	12 mm	55	033329
V3333	13 mm	55	033336
V3334	14 mm	55	033343
V3335	17 mm	55	033350
V3336	19 mm	55	033367
V3337	22 mm	55	033374
V3338	24 mm	55	033381

VDE Schraubendreher-Einsatz

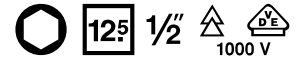

VIGOR No.	SW	L mm	EAN 4047728+
V3339	5 mm	78	033398
V3344	6 mm	78	033442
V3340	8 mm	78	033404

VDE Schlitz-Schraubendreher

• Nach DIN/ISO gefertigt

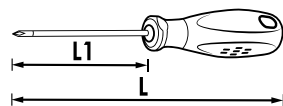
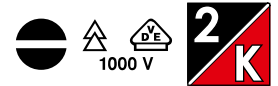

VIGOR No.	SW	L1 mm	L mm	EAN 4047728+
V2028	0.5x3 mm	100	181	020282
V2029	0.8x4 mm	100	181	020299
V2030	1x5.5 mm	125	231	020305
V2061	1.2x6.5 mm	150	256	020619



VDE Kreuzschlitz-Schraubendreher

• Nach DIN/ISO gefertigt

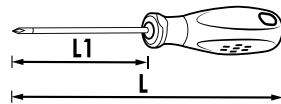
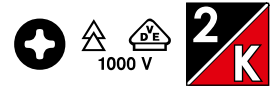

VIGOR No.	SW	L1 mm	L mm	EAN 4047728+
V2062	PH0	60	141	020626
V2063	PH1	80	161	020633
V2064	PH2	100	206	020640

V2027, EAN 4047728020275

VDE Schraubendreher Satz

• Nach DIN/ISO gefertigt



xx		Ausführung	SW
4 x	⊖		0.5x3 · 0.8x4 · 1x5.5 · 1.2x6.5 mm
3 x	⊕		PH0 · PH1 · PH2

Spannungsprüfer



VIGOR No.	SW	mm	EAN 4047728+
V1138	0.5x3 mm	140	011389

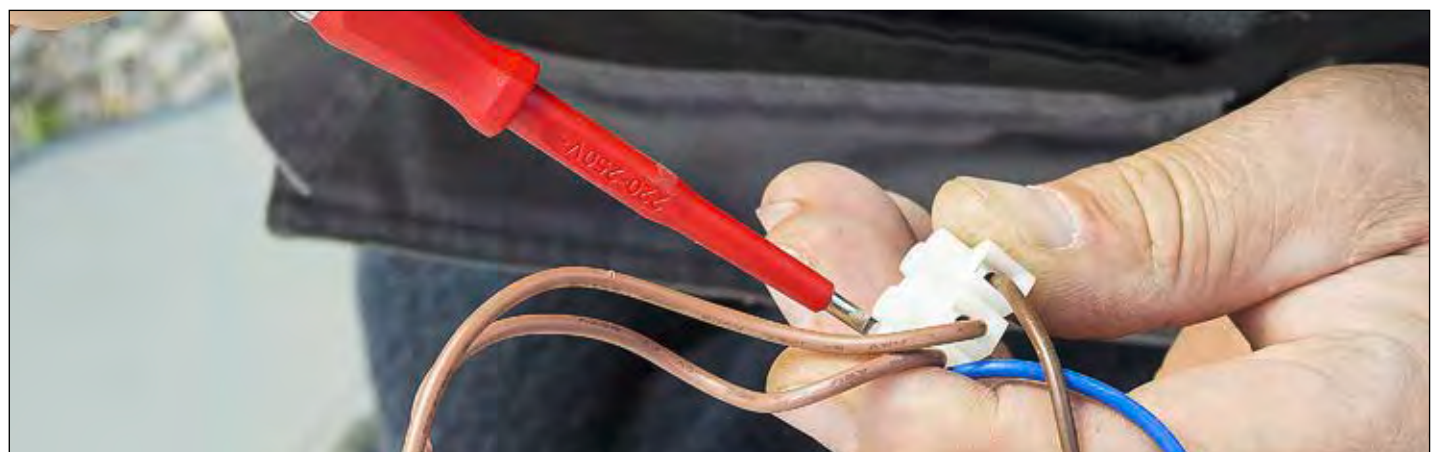

V2641, EAN 4047728**026413**

VDE Rundzange

• Lange Backen

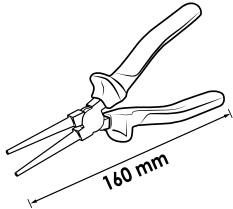

V2628, EAN 4047728**026284**

VDE Kombizange

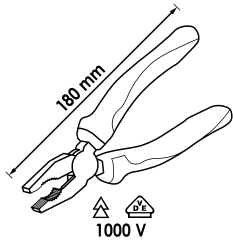

V2629, EAN 4047728**026291**

VDE Seitenschneider

• Für harten Draht (H)

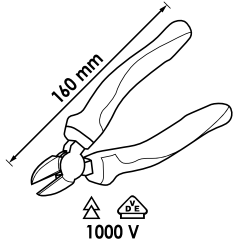

V2630, EAN 4047728**026307**

VDE Flachrund-Zange

• Mit Schneide

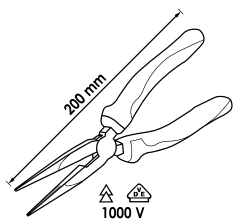

V2643, EAN 4047728**026437**

VDE Abisolierzange

• Feder und Stellschraube

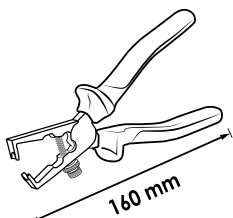

Schlosser-Hammer

- Eschestiel



VIGOR No.	— L — mm	⚖ g	EAN 4047728+
V1135	300	300	011358
V2662	320	500	026628
V2665	350	800	026659
V2664	360	1000	026642
V2663	400	2000	026635

Fäustel

- Eschestiel



VIGOR No.	— L — mm	⚖ g	EAN 4047728+
V4235	280	1500	042352

Kunststoff-Schonhammer

- Auswechselbare Köpfe aus schlagfestem Cellulose-Acetat
- Eschestiel



VIGOR No.	Durchmesser max	— L — mm	EAN 4047728+
V1212	32	280	012126
V4661	40	320	046619



VIGOR No.	Bezeichnung	∅ mm	EAN 4047728+
V3541	Ersatzkopf (Paar) für Kunststoff- Schonhammer V1212	32	035415
V4661-1	Ersatzkopf (Paar) für Kunststoff- Schonhammer V4661	40	048514



V1221, EAN 4047728012218

Flachmeißel



V1222, EAN 4047728012225

Kreuzmeißel

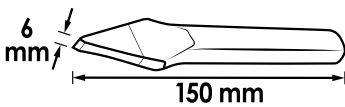

V1220, EAN 4047728012201

Körner

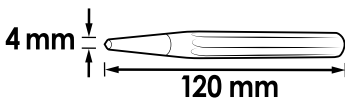

V1783, EAN 4047728017831

Körner · selbstschlagend

• Schlagkraft wird durch einfaches Niederdrücken des Oberteils freigesetzt

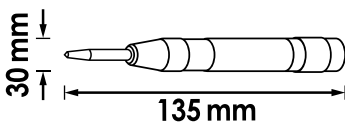

Stufenlos einstellbar



Splintreiber



VIGOR No.	Ø	mm	EAN 4047728+
V1214	2	150	012140
V1215	3	150	012157
V1216	4	150	012164
V1217	5	150	012171
V1218	6	150	012188
V1219	8	150	012195

V1283, EAN 4047728012836

Schaber Satz · Edelstahl

- Entfernen von Dichtungsrückständen an Zylinderkopf-, Ventildeckel-, Vergaserdeckeldichtungen etc.
- Klängen aus Edelstahl
- Aufhängeloch
- 4-teiliger Satz

Mit Schlagkappe

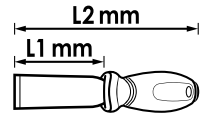

VIGOR No.	mm	mm	Meisselhöhe	EAN 4047728+
V2487	230	32	1,2	024877
V2488	230	32	2,5	024884
V2509	175	20	1,2	025096
V2508	175	20	2,5	025089



V1368N, EAN 4047728071017

Universalschaber

- Entfernen von Vignetten, Plaketten und Aufklebern
- Auch für Ceranfeld, Windschutzscheibe etc. geeignet
- Klinge schnell und sicher auswechselbar
- Inklusive einer Klinge



V1372, EAN 4047728013727

Ersatzklingen



V1213, EAN 4047728012133

Dichtungsschaber · lang

- Entfernung von Dichtungsrückständen an Zylinderkopf-, Ventildeckel-, Vergaserdeckeldichtungen etc.
- Lange Ausführung
- Griff aus Kunststoff



V4663, EAN 4047728046633

Mini Haken Satz

- Einsetzen und Entfernen von O-Ringen oder Dichtungen
- Auch zum Entfernen der Schutzkappen bei Radbolzen
- Aufhängeloch
- Kurze Ausführung



V5045, EAN 4047728050456

Haken- und Schaber Satz

- Entfernen und Einsetzen von O-Ringen und Dichtungen sowie zum Entfernen von Plaketten, Dichtungs- und Klebstoffresten
- Auch zum Entfernen von Schutzkappen bei Radbolzen
- Mit Aufhängeloch

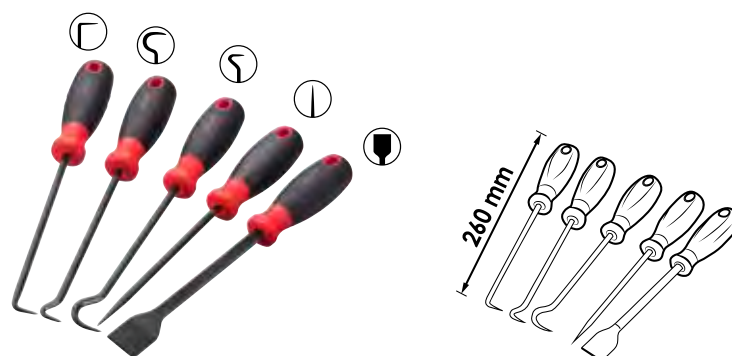

V6210-4, EAN 4047728065948

Körner

- Markierung der zu bearbeiteten Komponenten
- Ergonomischer Zweikomponenten-Griff
- Sicherer Halt
- Reduzierung der Vibrationen beim Schlagen
- Verlängerter Schlagkopf
- Spitze Ø 4 mm
- Körner 4x10x185 mm



V6210-10, EAN 4047728065931

Körner

- Markierung der zu bearbeiteten Komponenten
- Ergonomischer Zweikomponenten-Griff
- Sicherer Halt
- Reduzierung der Vibrationen beim Schlagen
- Verlängerter Schlagkopf
- Spitze Ø 10 mm
- Körner 10x12x185 mm



V6230-5, EAN 4047728065986

Kreuzmeißel

- Sicheres, einfaches Trennen von Komponenten oder Bauteilen
- Ergonomischer Zweikomponenten-Griff
- Sicherer Halt
- Reduzierung der Vibrationen beim Schlagen
- Verlängerter Schlagkopf
- Klingenbreite: 5 mm
- Kreuzmeißel 5x10x170 mm



V6230-7, EAN 4047728065993

Kreuzmeißel

- Sicheres, einfaches Trennen von Komponenten oder Bauteilen
- Ergonomischer Zweikomponenten-Griff
- Sicherer Halt
- Reduzierung der Vibrationen beim Schlagen
- Verlängerter Schlagkopf
- Klingenbreite: 7 mm
- Kreuzmeißel 7x12x190 mm



V6200, EAN 4047728061940

Splinttreiber Satz

- Ergonomischer 2-Komponenten-Griff
- Sicherer Halt
- Deutliche Reduzierung des Verletzungsrisikos dank Handschutz
- Reduzierung der Vibrationen beim Schlagen
- Verlängerter Schlagkopf
- 7 verschiedene Größen (Treibdorn Ø 2 – 8 mm)
- Aufbewahrung in praktischer Rolltasche

VIGOR No.	Ø	L mm	EAN 4047728+
V6200-2	2	140	061957
V6200-3	3	150	061964
V6200-4	4	180	061971
V6200-5	5	200	061988
V6200-6	6	210	061995
V6200-7	7	210	062008
V6200-8	8	220	062015



V6220/4, EAN 4047728066006

Flachmeißel Satz

- Sicheres, einfaches Trennen von Komponenten oder Bauteilen
- Ergonomischer Zweikomponenten-Griff
- Sicherer Halt
- Reduzierung der Vibrationen beim Schlagen
- Verlängerter Schlagkopf
- 4 verschiedene Größen: 10 · 16 · 20 · 29 mm
- Aufbewahrung in praktischer Rolltasche

VIGOR No.	L mm	W mm	Meißelhöhe	EAN 4047728+
V6220-10	140	10	8	065955
V6220-16	170	16	10	065962
V6220-20	210	20	14	065979
V6220-29	250	29	18	063890



V6030, EAN 4047728060301

Schaber Satz

- Entfernen von Plaketten, Aufklebern, Vignetten oder Kleberesten etc.
- Weitere Anwendungsbereiche: Entfernen von Motordichtungen, z.B. am Zylinderkopf oder Ventildeckel
- Einfaches Auswechseln der Klingen durch Lösen der Verschraubung am Spannfutter
- Verschiedene Klingen ermöglichen Anpassung auf unterschiedliche Anwendungsbereiche



VIGOR No.	Bezeichnung	W mm	EAN 4047728+
V6030-12	Ersatzklingen	12	062121
V6030-16	Ersatzklingen	16	062138
V6030-20	Ersatzklingen	20	062145



V1371, EAN 4047728069687

Lösehebel Satz

- Filigrane Arbeiten an Türverkleidungen, Armaturenbrett, Gummidichtungen, Zierleisten etc.
- Schlanke und stabile Ausführung
- Vielfältig einsetzbar in Werkstatt oder Haushalt



VIGOR No.	EAN 4047728+
V1371-1	069649
V1371-2	069700
V1371-3	069656
V1371-4	069694
V1371-5	069670
V1371-6	069632
V2491	024914
V2492	024921
V2493	024938
V2494	024945
V2495	024952

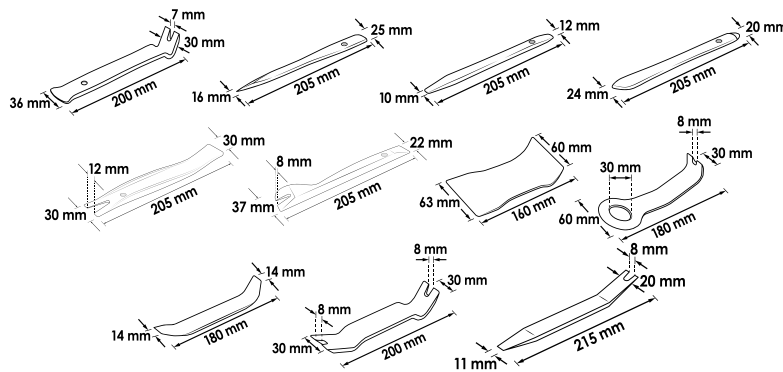

In praktischer Rolltasche



V1369, EAN 4047728013697

Lösehebel Satz

- Filigrane Arbeiten an Türverkleidungen, Armaturenbrett, Gummidichtungen, Zierleisten etc.
- Verursacht keine Kratzer
- Schlanke und stabile Ausführung
- Vielfältig einsetzbar in Werkstatt oder Haushalt



VIGOR No.	EAN 4047728+
V2491	024914
V2492	024921
V2493	024938
V2494	024945
V2495	024952

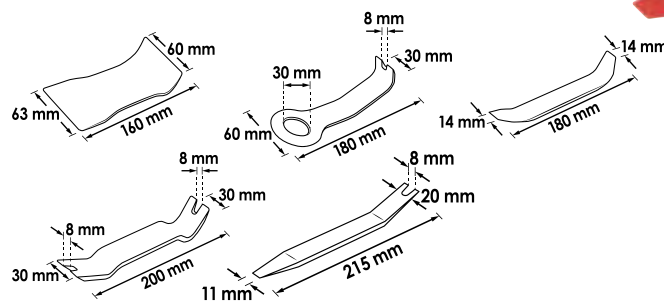

V4885, EAN 4047728**048859**

Clip Löse Satz

- Metall- und Kunststoff-Clips von Fahrzeugverkleidungen
- Aufhängeloch

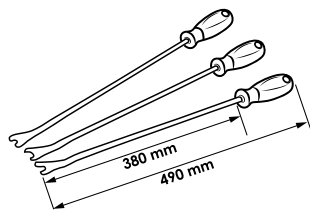

V5885, EAN 4047728**073851**

Clip Löse Satz

- Metall- und Kunststoff-Clips von Fahrzeugverkleidungen
- Aufhängeloch

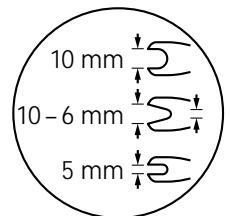
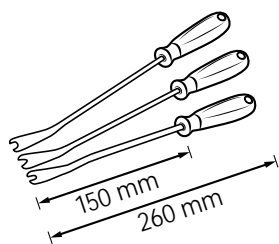

V4310N, EAN 4047728**062817**

Lösehebel

- Schmale Bauart – zum Arbeiten in schwer zugänglichen Bereichen z.B. Demontage der Kunststoff-Clips von Tür- und Heckklappen-Verkleidungen
- Länge: 165 mm

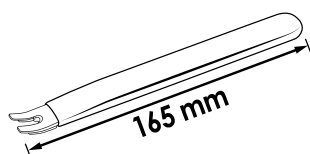

Kunststoffschutz zum beschädigungsfreien Arbeiten



V1301, EAN 4047728013017

Hebeleisen Satz

- Schlagfestes Heft



V6952, EAN 4047728069526

Mini-Lösehebel Satz

- Batteriewechsel bei Autoschlüsseln oder Arbeiten am Armaturenbrett
- Handlich, fein und vielfältig einsetzbar



Beschädigungsfreies Arbeiten an lackierten Stellen



V5591, EAN 4047728055918

Bandmaß

- Millimetergenaue Ermittlung kurzer Distanzen bis 5 m
- Länge: 5 m, Breite: 19 mm
- Handschleife und Gürtelclip
- Magnetischer Anschlag
- Handregulierter Bandeinzug und Bandlaufperre
- Federbandstahl



V1714, EAN 4047728017145

Fühlerlehren Satz

- Prüfen von Spaltmaßen, Kontaktabständen, Zwischenräumen
- Feststellmutter
- Blätter konisch zulaufend
- 20 Blatt
- 0,05 – 1,00 mm



Diverse Handwerkzeuge Schneiden und Sägen



V4690, EAN 4047728046909

Messschieber · analog

- Außen- und Innen-Messung im Bereich 0 – 150 mm
- Millimeter- und Zoll-Teilung
- Nonius 0,05 mm und $\frac{1}{128}$ "
- Feststellschraube
- Tiefen-Messstab
- Im Kunststoffkasten
- DIN 862



V1713, EAN 4047728017138

Messschieber · digital

- Außen- und Innen-Messung im Bereich 0 – 150 mm
- Millimeter- und Zoll-Teilung
- Digitale Anzeige
- 1,5 V (LR 44) – 180 mAh
- Feststellschraube
- Tiefen-Messstab
- Im Kunststoffkasten



Umschaltung mm / inch



V1304, EAN 4047728013048

Universalschere

- Lange, hochwertige Schneiden
- Klinge aus Edelstahl

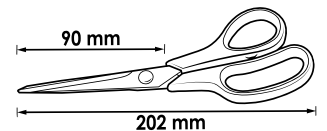

V1715, EAN 4047728017152

Sägebogen

- Handelsübliche Sägeblätter

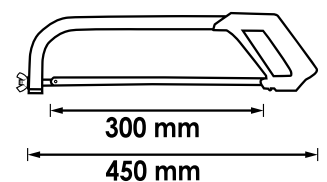

V2790N, EAN 4047728075664

Handbügel-Säge · klein

- Handelsübliche Sägeblätter

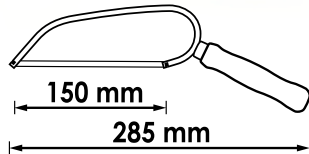
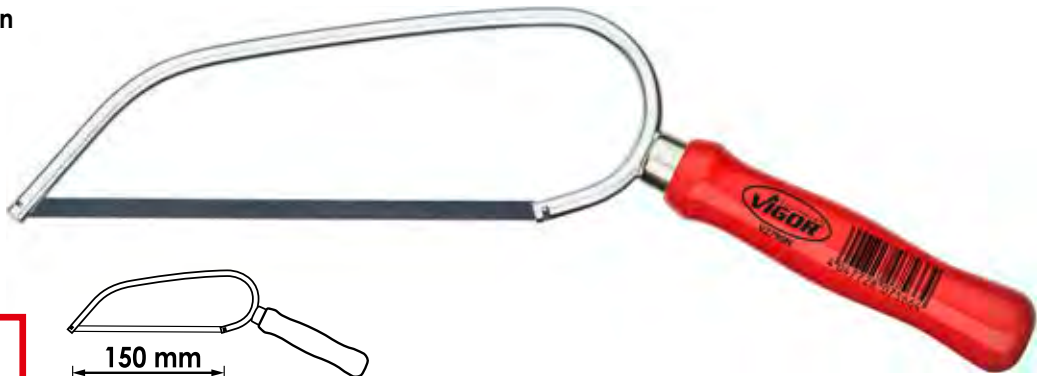

V4651, EAN 4047728046510

Klappmesser · Outdoor

- Klingenlänge: 86 mm
- Gesamtlänge: 185 mm
- Klinge aus Edelstahl
- Griffgehäuse aus Aluminium



Mit Arretierung

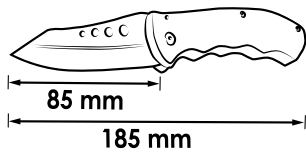

V2627, EAN 4047728026277

Universalmesser

- Abbrechklinge 9 mm
- Gehäuse aus Edelstahl
- Taschen-Clip

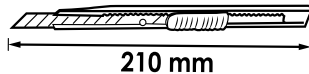

V4308, EAN 4047728043083

Abbrechklingen · 9 mm

- Klingen bestehen aus 12 Einzelklingen, die sich nach Verschleiß abtrennen lassen
- Für Universalmesser V2627



V4275, EAN 4047728042758

Universalmesser

- Rutschfester Komfortgriff
- Stahlgeführte Klingensicherung zur Unfallminimierung
- Schnellwechsel-Magazin
- Inklusive 6 Abbrechklingen (V4274)

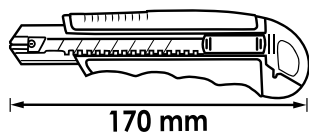

V4274, EAN 4047728042741

Abbrechklingen · 18 mm

- Klingen bestehen aus acht Einzelklingen, die sich nach Verschleiß abtrennen lassen
- Für Universalmesser V4275



V7099, EAN 4047728070997

Universal Klappmesser

- Universell einsetzbar in Lager, Garten, Haushalt, Werkstatt oder Industrie
- Einklappbar, daher verringertes Verletzungsrisiko
- Klingensicherung in offener Position
- Schneller Klappenwechsel
- Hochwertiges Aluminiumgehäuse

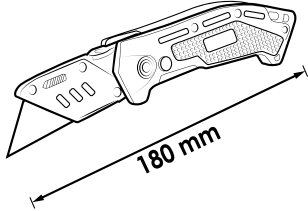

V1446, EAN 4047728014465

Trapez-Ersatzklingen

- Durch Trapezform 2-fach verwendbar
- Für Universalmesser V1345 · V7099
- Mit zwei Aufnahmen



V7099-S, EAN 4047728071000

Universal Klappmesser · mini

- Universell einsetzbar in Lager, Garten, Haushalt, Werkstatt oder Industrie
- Einklappbar, daher verringertes Verletzungsrisiko
- Klingensicherung in offener Position
- Schneller Klappenwechsel
- Hochwertiges Aluminiumgehäuse

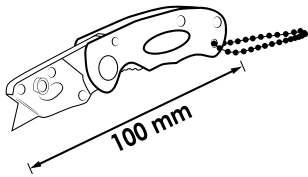

V1447, EAN 4047728070966

Trapez-Ersatzklingen

- Durch Trapezform 2-fach verwendbar
- Für Universalmesser V7099-S



V7099/2, EAN 4047728071123

Universal Klappmesser Satz

- Universell einsetzbar in Lager, Garten, Haushalt, Werkstatt oder Industrie
- Einklappbar, daher verringertes Verletzungsrisiko
- Klingensicherung in offener Position
- Schneller Klappenwechsel
- Hochwertiges Aluminiumgehäuse



V1345, EAN 4047728013451

Universalmesser

- Aluminiumgehäuse
- Schnellwechsel-Magazin
- Inklusive 10 Trapez-Ersatzklingen (V1446)

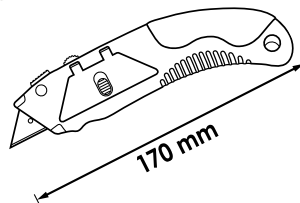

V1446, EAN 4047728014465

Trapez-Ersatzklingen

- Durch Trapezform 2-fach verwendbar
- Für Universalmesser V1345 · V7099
- Mit zwei Aufnahmen



V1787, EAN 4047728017879

Flachstumpf-Feile

- Zahnung (Hieb): 2 = mittel
- DIN 7261

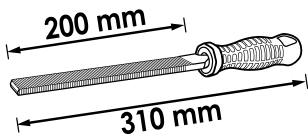

V1788, EAN 4047728017886

Dreikant-Feile

- Zahnung (Hieb): 2 = mittel
- DIN 7261

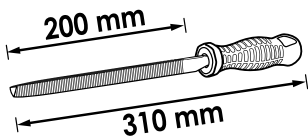

V1789, EAN 4047728017893

Vierkant-Feile

- Zahnung (Hieb): 2 = mittel
- DIN 7261

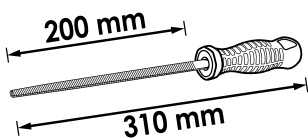

V1790, EAN 4047728017909

Halbrund-Feile

- Zahnung (Hieb): 2 = mittel
- DIN 7261

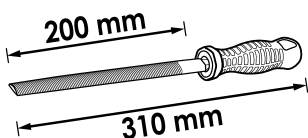

V1801, EAN 4047728018012

Rund-Feile

- Zahnung (Hieb): 2 = mittel
- DIN 7261

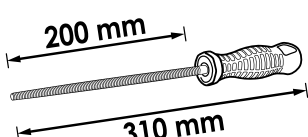

V2626, EAN 4047728**026260**

Rohrschneider

- Für Rohre aus Kupfer, Messing, Leichtmetall und PVC-Hartkunststoff

Ø 3 – 16 mm



V3309, EAN 4047728**033091**

Ratschen-Rohrschneider für Auspuff

- Schneidet Edelstahl, Stahl, Kupfer, Aluminium
- Ratschenfunktion:
 - erlaubt Arbeiten auch an schwer zugänglichen Stellen
 - erleichtert Führung des Abschneidegriffes um das Rohr
- Arbeitsbereich: 32 – 67 mm
- Schnitttiefe: 3 mm



V3451, EAN 4047728**034517**

Ersatzklingen

- Ersatzklingen für Auspuff-Ratschenrohrschneider V3309



V1707, EAN 4047728**017077**

HSS-Stufenbohrer Satz

VIGOR No.	Ø mm	l mm	EAN 4047728+
V2394	4-12	65	023948
V2395	4-20	75	023955
V2396	4-30	100	023962



V6809-4, EAN 4047728**067720**

Drahtbürste · Stahl · 4-reihig

- Bearbeiten von Stahl
- Stahlborsten
- Draht: 0,30 mm



V6807-4, EAN 4047728**067713**

Drahtbürste · Messing · 4-reihig

- Schonende Bearbeitung empfindlicher Oberflächen
- Messingborsten
- Draht: 0,30 mm



V6800-50, EAN 4047728067621

Topfbürste · grob

- Beseitigung von groben Belägen und Rückständen sowie starkem Rost
- Stahldraht
- 6 mm Einspannschaft
- Maximal 4500 U/min
- 50 mm Ø
- Besatzhöhe 17 mm

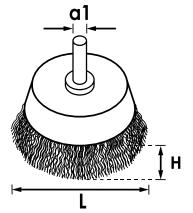

V6800-75, EAN 4047728067638

Topfbürste · grob

- Beseitigung von groben Belägen und Rückständen sowie starkem Rost
- Stahldraht
- 6 mm Einspannschaft
- Maximal 4500 U/min
- 75 mm Ø
- Besatzhöhe 20 mm

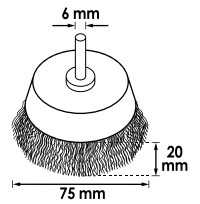

V6802, EAN 4047728067645

Pinselkopfbürste

- Entgraten, Entlacken, Entrosten und Reinigen
- Stahldraht
- 25 mm Ø
- 6 mm Einspannschaft
- Maximal 4500 U/min

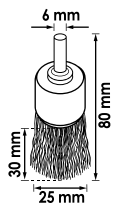

V6803-100, EAN 4047728067669

Scheibenbürste

- Entfernen von Anlassfarbe an Schweißnähten
- Stahldraht
- 6 mm Einspannschaft
- Maximal 4500 U/min
- 100 mm Ø

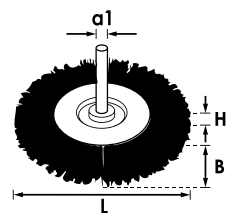

V6803-75, EAN 4047728067652

Scheibenbürste

- Entfernen von Anlassfarbe an Schweißnähten
- Stahldraht
- 6 mm Einspannschaft
- Maximal 4500 U/min
- 75 mm Ø

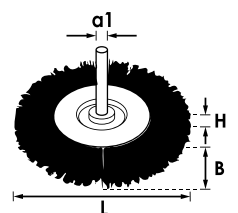

V6806, EAN 4047728**067676**

Scheibenbürste · gezopft

- Beseitigung von groben Belägen und Rückständen sowie starkem Rost oder Verzunderungen
- Stahldraht
- Gezopfte Ausführung
- 75 mm Ø
- Maximal 12500 U/min

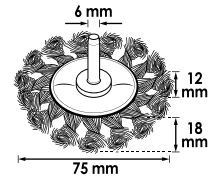

V6804, EAN 4047728**067690**

Scheibenbürste

- Entgraten, Entlacken, Entrosten und Reinigen
- Gehärteter Stahldraht
- Gezopfte Ausführung
- 115 mm Ø
- Gewinde: M 14x2,0
- Maximal 12500 U/min

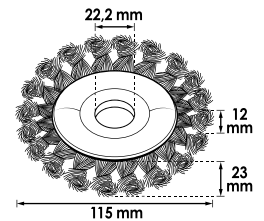

V6805, EAN 4047728**067706**

Kegelbürste

- Kegelform für schwer zugängliche Stellen
- Gehärteter Stahldraht
- Gezopfte Ausführung
- 100 mm Ø
- Gewinde: M 14x2,0
- Maximal 12500 U/min

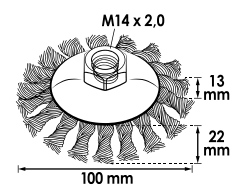

V6801-65, EAN 4047728**067683**

Topfbürste

- Schwere Bürstarbeiten auf größeren Flächen sowie zum Entgraten, Entrosten und Reinigen
- Stahldraht
- Gezopfte Ausführung
- 65 mm Ø
- Gewinde: M 14x2,0
- Maximal 12500 U/min

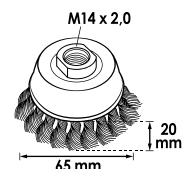



**Drehmoment-
Werkzeuge**

Drehmomentschlüssel Drehwinkel-Messgerät



Drehmomentschlüssel

- Drehmoment-Auslösung: Haptisch und akustisch
- $\pm 4\%$ Auslöse-Genauigkeit vom Skalenwert (in Betätigungsrichtung)
- Mit Seriennummer und Zertifikat
- DIN EN ISO 6789-2:2017, DIN 3120, ISO 1174-1A
- 72 Zähne
- 5° Betätigungswinkel

MADE IN GERMANY

12⁵ 1/2"



$\pm 4\%$

Kein Zurückdrehen mehr nötig

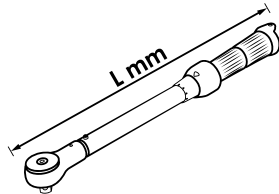

12⁵ 1/2" 72 5°

VIGOR No.	Nm	12 ⁵ 1/2"	L mm	Toleranz	EAN 4047728+
V3898	20 - 120	12 ⁵ 1/2"	445	4	038980
V3441	40 - 200	12 ⁵ 1/2"	540	4	034418
V3899	60 - 320	12 ⁵ 1/2"	610	4	038997

Feinverzahnte Umschaltknarre



Skalenteilung: 1 Nm



Doppelskala: Nm und lbf.ft.



Griff mit Aufhängöse



V2795, EAN 4047728027953

Drehwinkel-Messgerät

- Feinauflösung (0,1°)
- Drehwinkelbereich bis 999° (addierend)
- Winkelmessungen gegen und im Uhrzeigersinn
- 99 Speicherplätze
- Anzeige für Batterieladestatus
- LED-Alarmanzeige (blinkend)
- Summeralarm-Anzeige
- Akustischer Warnton
- Automatische Abschalfunktion



$\pm 2\%$





Pneumatik- Werkzeuge

Schlagschrauber

231–232

Luftratschen

233

Stabschleifer

234

Pneumatik-Pistolen

235–237

Schlagschrauber



V5671N, EAN 4047728076715

Schlagschrauber · Mini

- Kompakte Bauweise für beengte Platzverhältnisse
- Mehrstufiger Rechts- / Linkslauf mit Einhand-Umstellung
- Ablufführung durch Handgriff nach unten
- Kälteisolierender Griff
- Hochleistungs-Jumbohammer-Schlagwerk
- Ergonomisch geformter Handgriff und Gehäuse für verbesserte Handhabung und Bedienung
- Stoßfänger an der Gehäusesseite schützt den Luftmotor

12⁵ 1/2"



NEU

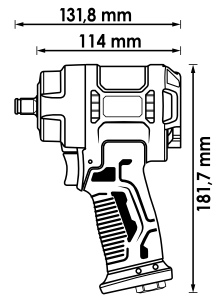

**Maximales Lösemoment
1200 Nm**



12.91(4) 7.2

Inklusive Kupplungsstecker

VIGOR No.	12 ⁵ 1/2"	max. Nm	Nm	Nm	1/min	kg	Ø mm	l/min	bar	dB (A)	m/s ²	EAN 4047728+
V5671N	12 ⁵ 1/2"	850	600	1200	10000	1.28	10	141.5	6.3	95.3	6.81	076715

V4800N, EAN 4047728075633

Schlagschrauber

- Ablufführung durch Handgriff nach unten
- Kälteisolierender Griff
- Hochleistungs-Doppelhammer-Schlagwerk
- Ergonomisch geformter Handgriff und Gehäuse für verbesserte Handhabung und Bedienung
- Stoßfänger an der Gehäusesseite schützt den Luftmotor

ECO GIANT



12⁵ 1/2"



Hochleistungs-Doppelhammer-Schlagwerk

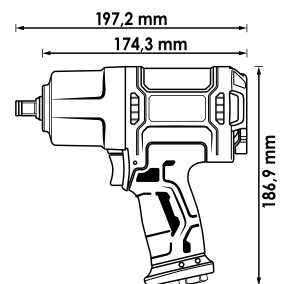

**Maximales Lösemoment:
1720 Nm**



12.91(4) 7.2

Inklusive Kupplungsstecker

VIGOR No.	12 ⁵ 1/2"	max. Nm	Nm	Nm	1/min	kg	Ø mm	l/min	bar	dB (A)	m/s ²	EAN 4047728+
V4800N	12 ⁵ 1/2"	1100	850	1720	7000	2.3	10	198.1	6.3	96.7	6.47	075633



V6899N, EAN 4047728**076944**

Schlagschrauber

- Mehrstufiger Rechts- / Linkslauf mit Einhand-Umstellung
- Kälteisolierender Griff
- Abluftführung durch Handgriff nach unten
- Hochleistungs-Doppelhammer-Schlagwerk
- Ergonomisch geformter Handgriff und Gehäuse für verbesserte Handhabung und Bedienung
- Stoßfänger an der Gehäusesseite schützt den Luftmotor



20 3/4"



NEU

**Maximales Lösemoment
2300 Nm**

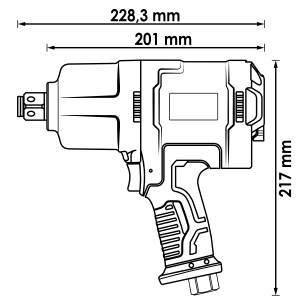

12.91 (w) 7.2

Inklusive Kupplungsstecker

VIGOR No.	max. Nm	Nm	Nm	1/min	kg	Ø mm	l/min	bar	dB (A)	m/s ²	EAN	
V6899N	20 3/4"	2000	1400	2300	5500	3.6	13	254.8	6.3	97.9	5.75	4047728+ 076944

V3653, EAN 4047728**036535**

Schlagschrauber

- Mehrstufiger Rechts- / Linkslauf mit Einhand-Umstellung
- Abluftführung durch Handgriff nach unten
- Kälteisolierender Griff
- Hochleistungs-Doppelhammer-Schlagwerk
- Ergonomisch geformter Handgriff und Gehäuse für verbesserte Handhabung und Bedienung

GIGA GIANT



12⁵ 1/2"



Hochleistungs-Doppelhammer-Schlagwerk

**Maximales Lösemoment:
1890 Nm**

Mehrstufiger Rechts-/ Linkslauf mit Einhand-Umschaltfunktion

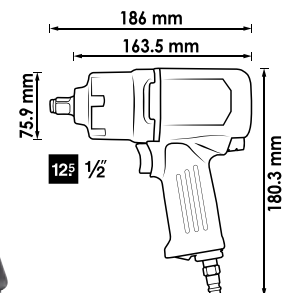

12⁵ 1/2"

12.91 (w) 7.2

Inklusive Kupplungsstecker

VIGOR No.	max. Nm	Nm	Nm	1/min	mm	kg	Ø mm	l/min	bar	dB (A)	m/s ²	EAN
V3653	12 ⁵ 1/2"	1290	700	1890	8500	1.95	10	113	6.3	96	12.92	4047728+ 036535

V5674, EAN 4047728056748

Luftratsche

- Für beengte Platzverhältnisse
- Umschaltfunktion am Ratschenkopf

QUICKGIANT

6.3 1/4"

12.91(€) 7.2

Inklusive Kupplungsstecker

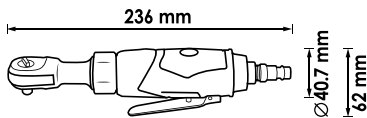

VIGOR No.		max. Nm	1/min	L mm	kg	Ø mm	l/min	bar	dB (A)	m/s ²	EAN 4047728+
V5674	6.3 1/4"	35.2	240	236	0.6	10	77	6.3	87.5	3.47	056748

V6554, EAN 4047728065542

Luftratsche

- Für beengte Platzverhältnisse
- Umschaltfunktion am Ratschenkopf

QUICKGIANT

10 3/8"

12.91(€) 7.2

Inklusive Kupplungsstecker

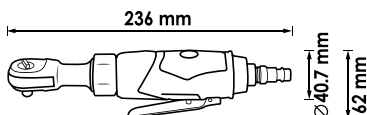

VIGOR No.		max. Nm	1/min	L mm	kg	Ø mm	l/min	bar	dB (A)	m/s ²	EAN 4047728+
V6554	10 3/8"	35.2	240	236	0.6	10	77	6.3	87.5	3.47	065542

V5675, EAN 4047728056755

Luftratsche

- Für beengte Platzverhältnisse
- Umschaltfunktion am Ratschenkopf

QUICKGIANT

12.5 1/2"

12.91(€) 7.2

Inklusive Kupplungsstecker

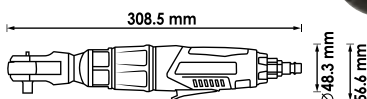

VIGOR No.		max. Nm	1/min	L mm	kg	Ø mm	l/min	bar	dB (A)	m/s ²	EAN 4047728+
V5675	12.5 1/2"	67	160	308.5	1.2	10	114	6.3	100.5	3.47	056755



V5672, EAN 4047728056724

Stabschleifer · gerade

- Fräser, Trennscheiben, Schleifkörper mit 3 und 6 mm Spannutter



Inklusive Ø 3 mm Spannutter
Inklusive Ø 6 mm Spannutter

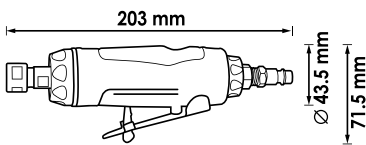

SPEED GIANT

12.91 (w) 7.2

Inklusive Kupplungsstecker



VIGOR No.	mm	1/min	mm	W Watt	kg	Ø mm	l/min	bar	dB (A)	m/s ²	EAN 4047728+
V5672	3-6 mm	22000	203	350	0.54	10	128.2	6.3	97.1	2.90	056724

V5673, EAN 4047728056731

Stabschleifer · abgewinkelt

- Fräser, Trennscheiben, Schleifkörper mit 3 und 6 mm Spannutter



Inklusive Ø 3 mm Spannutter
Inklusive Ø 6 mm Spannutter

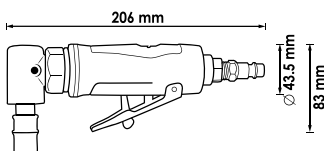

SPEED GIANT

12.91 (w) 7.2

Inklusive Kupplungsstecker



VIGOR No.	mm	1/min	mm	W Watt	kg	Ø mm	l/min	bar	dB (A)	EAN 4047728+
V5673	3-6 mm	20000	206	250	0.45	10	85.5	6.3	101.6	056731

V6906, EAN 4047728069069

Stabschleifer Satz · Mini

- Gerade Ausführung
- Kleine Ausführung für beengte Platzverhältnisse
- Zum Schleifen, Polieren oder Entgraten
- Inklusive Spannutter für 3 und 6 mm Aufnahmen
- Ablufführung durch Handgriff nach unten
- Inklusive 10-teiligem Schleifstein Satz V6906-10

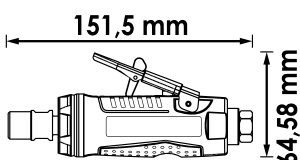

SPEED GIANT

V6906-10, EAN 4047728069571

Schleifstein Satz

- Schleifsteine für VIGOR Stabschleifer V6906 · V5672 · V5673

10



VIGOR No.	mm	1/min	W Watt	kg	Ø mm	l/min	bar	dB (A)	EAN 4047728+
V6906	3-6 mm	25000	185	0.31	10	85	6.3	102	069069

V6905, EAN 4047728069052

Reifenfüller

- Einhandbedienung mit ergonomischem Griff
- Gummiummanteltes Manometer zum Schutz vor leichten Stößen
- Leicht ablesbares Präzisionsmanometer mit bar und PSI-Angabe
- Teilung: 0,1 bar
- Gut dosierbarer Füllhebel und Ablassknopf, einfach am Handgriff erreichbar
- Ablassknopf zur Nivellierung der Befüllmenge

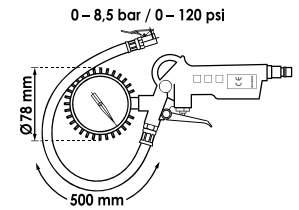

V7135, EAN 4047728071352

Ausblas-Pistole · kurz

- Schnelles Säubern oder Entfernen von Spänen und anderen Fremdkörpern
- Langlebiges Aluminium Gehäuse
- Aufhängevorrichtung eingearbeitet

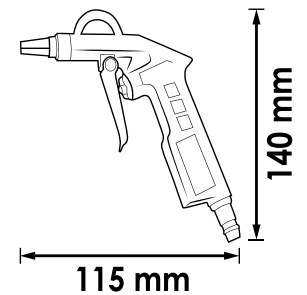
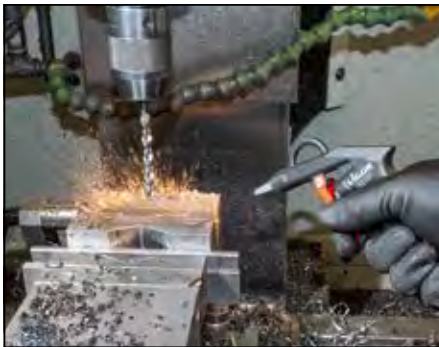

V7135-150, EAN 4047728071369

Ausblas-Pistole · lang

- Schnelles Säubern oder Entfernen von Spänen und anderen Fremdkörpern
- Langlebiges Aluminium Gehäuse
- Aufhängevorrichtung eingearbeitet

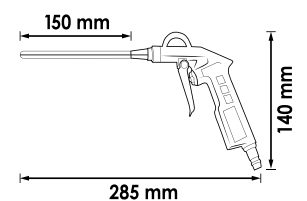

V7143-10, EAN 4047728071437

Schlauchaufroller

- Reduziert Unfallgefahr, da kein Schlauch herumliegt
- Kompaktes Gehäuse, inklusive Öffnungsklappe zur Beseitigung von Schmutz oder zum Richten des Schlauches
- Wandhalterung: 180° schwenkbar
- Automatisches Aufrollen durch geführten Einzugs
- Druckluftadapter vorinstalliert
- Hybrid Polymer-Schlauch
- Auto Stop Funktion
- Schlagfestes Gehäuse aus Polypropylen
- Angepasste Einzugskraft
- Betriebsdruck maximal: 12 bar

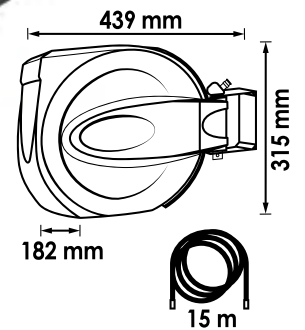

V4322, EAN 4047728**043229**

Unterbodenschutz-Pistole

- Für handelsübliche 1000 ml Kartuschen
- Beiliegender flexibler 500 mm-Schlauch mit Spreizdüse für Rundum-Wachsnebel ermöglicht problemlosen Wachsauftrag in Hohl- und Zwischenräumen
- Einfaches Auftragen des Unterbodenschutzes (bzw. Schallschutz) mit standardmäßig installierter Düse
- Anwendungstipp: Kartusche öffnen, Ansaugrohr eintauchen, Kartusche festschrauben. Fertig!



V6907, EAN 4047728**075497**

Mini-Fettpresse

- Einfaches Wechseln der Fetttube durch Schraubgewinde
- Fördermenge: 0,45 ml/Hub
- Schmiernippel in 30° und 90° Ausführung
- Innengewinde M15 x 1,5



V6907-1, EAN 4047728**075503**

Hochleistungs-Fett

- Fetten von Schlagwerken, Spindeln und Verschraubungen
- Austausch-Fetttube für V6907
- Korrosionsschutz durch gute Haft Eigenschaften auf metallischen Oberflächen
- Füllmenge: 100 ml
- Außengewinde: M 15 x 1,5

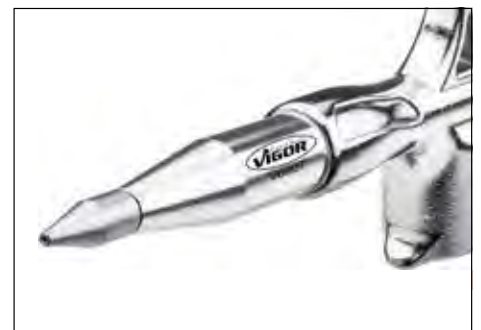



**Allgemeiner
Werkstattbedarf**

V4241, EAN 4047728**042413**

Schaltschrankschlüssel Sub Maker Quadro 10-in-1

- Für fast alle gängigen Schließungen in Sanitär, Heizung, Bau, Lüftung, Klima etc.

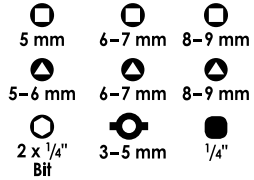

MADE IN GERMANY



V4228, EAN 4047728**042284**

Baustellenschlüssel MasterKey Bau

- Für gängige Schließungen in Sanitär, Heizung, Bau, Lüftung, Klima etc.
- Vierkant-Dorn ermöglicht Betätigen der Schloßnuss ohne Türdrücker und Vierkantschlüssel

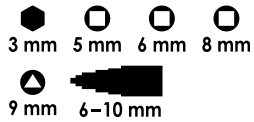

MADE IN GERMANY

Zinkdruckguss



V4227, EAN 4047728**042277**

Baustellenschlüssel MasterKey Elektro

- Für fast alle gängigen Schließungen in Sanitär, Elektro, Heizung, Lüftung, Klima etc.

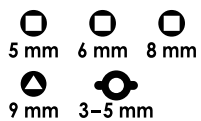

MADE IN GERMANY

Zinkdruckguss



V4279, EAN 4047728**042796**

Japanspachtel Satz · Metall

- Auftragen von Material bzw. zum Glätten von Oberflächen sowie zum Einsatz in vielen weiteren Anwendungsbereichen
- Breite Spachtel 50 · 80 · 100 · 120 mm

MADE IN GERMANY



Aus hochflexiblem Federbandstahl



V4278, EAN 4047728**042789**

Japanspachtel Satz · Kunststoff

- Auftragen von Material bzw. zum Glätten von Oberflächen sowie zum Einsatz in vielen weiteren Anwendungsbereichen
- Für Arbeiten im Karosseriebereich, z.B. Verfüllen von Löchern und Dellen sowie vielen weiteren Anwendungsbereichen
- Breite Spachtel 50 · 80 · 100 · 120 mm

MADE IN GERMANY



V5480, EAN 4047728**054799**

Teleskopspiegel Satz

- Sichtprüfung an schwer zugänglichen Stellen
- Federgespanntes Doppelgelenk zur Einsicht in unsichtbaren Bereichen
- Spiegel austauschbar über Schnellwechsel-System mit 6,3 mm Aufnahme

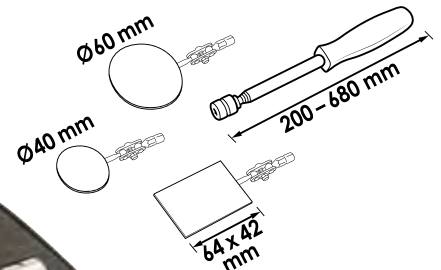

Spiegel austauschbar über Schnellwechsel-System



Schnelle Identifikation von z.B. Ölverlust, Korrosion oder Steckverbindungen



V1740, EAN 4047728**068673**

Magnetheber · semi-flexibel

- Ausziehbarer Magnet ermöglicht punktuelle Aufnahme
- Hochwertiger Kunststoffgriff
- Semi-flexibler Schaft



V1741, EAN 4047728**017411**

Teleskop-Magnetheber

- Aufnehmen von eisenhaltigen Teilen auch an unzugänglichen Stellen
- Ausziehbar
- Praktischer Taschen-Clip



V1764, EAN 4047728**017640**

Krallengreifer mit Magnet · flexibel

- Aufnehmen von Kleinteilen wie Schrauben, Muttern etc. an unzugänglichen Stellen
- Mit Magnet für zusätzlichen Halt
- Greif- und Magnetfunktion



V1438, EAN 4047728**014380**

Pinzetten Satz

- Filigrane Arbeiten z.B. an schwer zugänglichen Stellen
- Hohe Griffigkeit
- Edelstahl



V5512, EAN 4047728055123

Gas LötKolben Satz

- Löt-, Schmelz-, Schrumpf-, Heißschneid-Arbeiten durch sieben verschiedene Adapter
- Flexibler, autarker Einsatz durch Gasbetrieb
- Gerät kombiniert drei Funktionen in einem:
 - LötKolben, maximale Temperatur: 450° C
 - Brenner, maximale Temperatur: 1300° C
 - Heißluftfön, maximale Temperatur: 600° C
- Klein und handlich zur Durchführung direkter Arbeiten, z.B. am Fahrzeug
- Stufenlose Gasregulierung zur optimalen Einstellung auf durchzuführende Arbeit und Material
- Flamm-Temperatur maximal: 1300° C
- Standfuß für stationäres Arbeiten
- Piezozündung
- Befüllung mit handelsüblichem Feuerzeug- / ISO-Butangas
- Inhalt:
 - Gas-LötKolben
 - Lötspitze 3,5 mm
 - Lötspitze 4,5 mm
 - Schrumpfschlauch-Aufsatz
 - Schneid-Spitze
 - Lötswamm Schutzkappe
 - Lötdraht



Verbesserte Lötspitzen Füllstandanzeige



Gasventil



Edelstahl



Überall flexibel einsetzbar
durch Gasbetrieb

V5488, EAN 4047728054881

Mehrzweckwanne · 50 l

- Einsatz als Reinigungswanne, Schmutzwanne, Ölwanne, Aufbewahrungswanne, Desinfektionswanne, Leckagewanne, Transportwanne und Futterwanne z.B. im Sanitär- und Heizungsbau, Kfz-Industrie- und Werkstatt, Jagdbedarf, Chemie/Labor, Lebensmittelindustrie / Fleischerei, Angelsport, Tierbedarf, Pferdezubehör usw
- Lauge- und säurefest

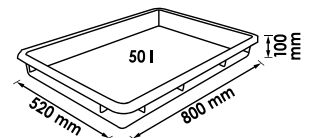

Universell einsetzbar mit großem
Fassungsvermögen



V5677, EAN 4047728056779

Magnetschale mit Kunststoff-Rahmen

- Zwei starke Magnete zur Befestigung an Hebebühnen, Werkstattwagen, Maschinen, etc
- Ablegen von magnetischen und nicht-magnetischen Kleinteilen – freie Hände zum Arbeiten
- Kunststoff-Rahmen bietet Ablagefläche für Kunststoffschrauben o.ä. und dient dadurch zusätzlich als Auffangschale
- Kleinteile werden gut sichtbar und wieder auffindbar abgelegt

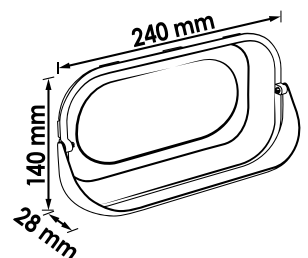

Kleiner Helfer für
große Ordnung



V5678, EAN 4047728070539

Magnet-Halbschale

- Aufbewahrung von Schrauben, Dichtungen oder Kleinteilen
- Befestigung an Werkstattwagen, Hebebühnen oder Metallschränken
- Für die Werkstatt, Produktionsstätte oder den Hobbykeller
- Stabiles Kunststoffgehäuse mit optimiertem Magneten
- Große Öffnung ermöglicht gute Sicht in die Halbschale
- Gummischutz am Magneten verhindert Beschädigungen
- Magnetschale beidseitig magnetisch – magnetische Kleinteile haften an der Rückwand
- Zusätzliche Stabilisierung unterhalb des Magneten für planes Aufliegen der Halbschale
- Magnethaltkraft: circa 2,5 kg

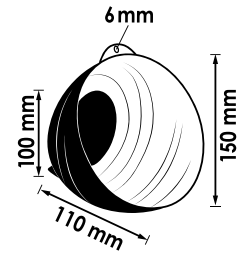

V6468, EAN 4047728064682

Düseninsteller mit Magnet

- DüsenEinstellung von Scheibenwaschanlagen
- Zusätzliche Funktion als Magnetheber
- Taschen-Clip



Schmale Einstecknadel \varnothing 0,6 mm

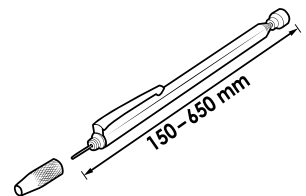

Inklusive Display bei einer Abnahme von mindestens 16 Stück



V7221, EAN 4047728072212

Waschdüsen-Einstellwerkzeug · MERCEDES-BENZ

- Beschädigungsfreies Einstellen von Fächerdüsen der Scheibenwaschanlage an MERCEDES-BENZ W204 · W207 · W212 · W218
- Optimales Einstellen von Fächerdüsen der Scheibenwaschanlage an MERCEDES-BENZ
- Passgenaues Düsenkopf Profil
- Außensechskantantrieb: 6 mm
- Für folgende Modelle: W204 · W207 · W212 · W218
- Gesamtlänge: 67 mm

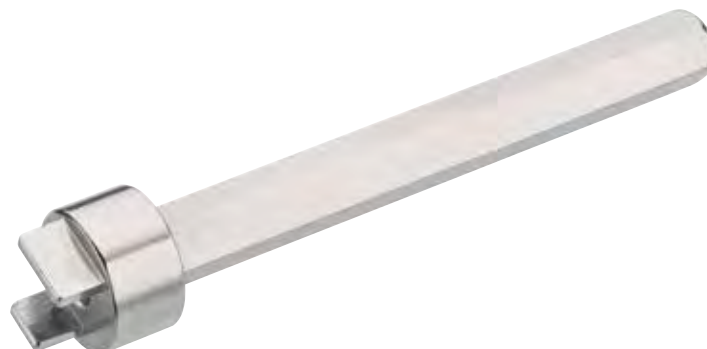

V6742, EAN 4047728067423

Werkzeug-Magnethalter

- Lagerung von Krafteinsätzen, Schlagschraubern, Drehmomentschlüsseln oder Schläuchen direkt an Ort und Stelle
- Starke Magneten (Ø je 80 mm) garantieren guten Halt an Hebebühnen, Werkstattwagen oder weiteren eisenhaltigen Untergründen
- Magnethaltekraft: circa 20 kg



Optimale Lagerung
von Krafteinsätzen
und Schlagschraubern
direkt an Ort und Stelle

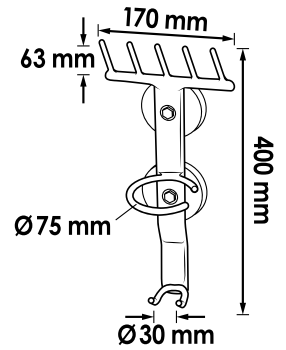

V6605, EAN 4047728066051

Kofflückschoner

- Schutz vor Beulen, Kratzern, Öl und Schmutz
- Universalgröße
- Kein Verdecken der Räder

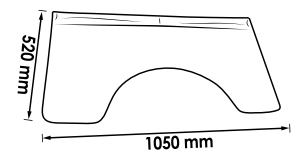

V6606, EAN 4047728066068

Mehrweg-Sitzschoner

- Schutz des Autositzes vor Verschmutzung
- Universalgröße, für die meisten Pkw und gängige Nutzfahrzeuge
- Leichtes Nylon, PU-beschichtet
- Wasser-, fett- und ölabweisend
- Inhalt: 1 Stück
- Waschbar bei 40° C

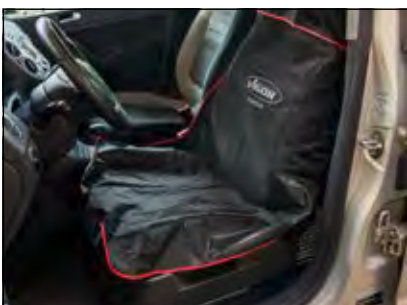

Maße: L: 1350 x B: 760 mm



Arbeitshandschuhe

- Montagearbeiten in der Werkstatt, Lager / Logistik und überall dort, wo hohe Griffsicherheit und Präzision wichtig sind
- Leichte Polyester-Strickhandschuhe mit ergonomischer Passform
- EN 388:2003 (3131A)



Schwarze
PU-Beschichtung auf
der Handinnenfläche

VIGOR No.	Handschuhgröße	EAN 4047728+	
V6435	9 / L	064354	
V6435-XL	10 / XL	069984	

Handschuhe · Grip

- Schützen die Hände vor Öl, Fett, Chemikalien und Dreck
- Oberflächenstruktur bietet gute Haftung, auch bei öligem Arbeitsbedingungen
- Sicherheitsfarbe orange für bessere Erkennbarkeit in dunklen Arbeitsräumen
- Komfortabler, reißfester Handschuh mit gutem Fingerspitzengefühl
- Touchscreen-kompatibel
- Material: Nitril
- Latex- und pulverfrei



NEU

VIGOR No.	EAN 4047728+	
V6436-L	077712	
V6436-XL	077729	
V6436-XXL	077736	

V2338, EAN 4047728023382

Kniekissen

- Komfortables Arbeiten in der Werkstatt, Industrie, Garten oder Haushalt
- Hochwertiger Schaumstoff
- Knieschonend
- Wärmeisolierend
- Wasser- und Ölabweisend
- Mit Tragegriff



Komfortables und gelenkschonendes
Arbeiten in der Werkstatt, Industrie,
im Garten oder Haushalt



V2338-XL, EAN 4047728071444

Mechaniker Matte

- Komfortables Arbeiten auf dem Boden in der Werkstatt, Industrie, Garten oder Haushalt
- Große Liegefläche
- Hochwertiger Schaumstoff
- Gelenkschonend
- Ergiebiger und warmhaltender Schaumstoff
- Mit zwei Tragegriffen

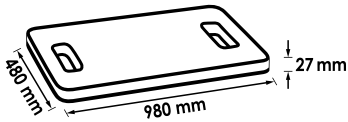

V6973, EAN 4047728069731

Montage-Rollbrett

- Gepolstertes Kopfteil
- Zwei seitliche Ablagefächer für Schrauben oder andere Kleinteile
- Hochwertige Verarbeitung aus Kunststoff
- Leicht zu reinigen
- Sechs Hartkunststoff-Rollen
- Belastbarkeit maximal 150 kg



Bequemes Arbeiten unter dem Fahrzeug

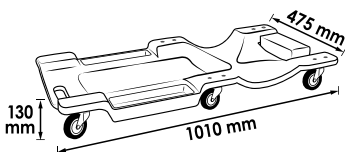

V6973-1, EAN 4047728069748

Ersatzrolle für Montage-Rollbrett



V2316, EAN 4047728023160

LED Knicklampe

- Li-Ion Akku 3,6 V
- 3,5 - 4 h
- 5 LED = 300 Lux bei 60 cm
- 18 LED = 800 Lux bei 60 cm
- circa 200 g
- Höhe: 220 mm
- IP30

5 LED =
5 h

Abnehmbar

18 LED =
1,5 h



V2347, EAN 4047728023474

12 V Ladegerät für LED Knicklampe V2316



V4646, EAN 4047728**046466**

Bürsten Satz

- Professionelles Reinigen und Entgraten von Zylindern, Röhren, Buchsen etc.
- Für Betrieb mit Bohrmaschinen und Druckluftbohrern (Bei Maschinenverwendung nur rechtslaufend einsetzen)
 - 12 Nylonbürsten: Ø 8 · 9 · 10 · 11 · 12 · 13 · 14 · 15 · 16 · 17 · 18 · 19 mm
 - 12 Stahlbürsten: Ø 8 · 9 · 10 · 11 · 12 · 13 · 14 · 15 · 16 · 17 · 18 · 19 mm
 - 12 Bürsten mit Messingbeschichtung: Ø 8 · 9 · 10 · 11 · 12 · 13 · 14 · 15 · 16 · 17 · 18 · 19 mm
 - 1 Handgriff mit Aufnahme und Schnellverriegelung
 - 1 Verlängerung 150 mm



Ersatzteile 10er Pack



VIGOR No.	Bezeichnung	EAN 4047728+
V4646M-8	Messingbürsten Satz Ø 8 mm	054102
V4646M-9	Messingbürsten Satz Ø 9 mm	054119
V4646M-10	Messingbürsten Satz Ø 10 mm	054126
V4646M-11	Messingbürsten Satz Ø 11 mm	054133
V4646M-12	Messingbürsten Satz Ø 12 mm	054140
V4646M-13	Messingbürsten Satz Ø 13 mm	054157
V4646M-14	Messingbürsten Satz Ø 14 mm	054164
V4646M-15	Messingbürsten Satz Ø 15 mm	054171
V4646M-16	Messingbürsten Satz Ø 16 mm	054188
V4646M-17	Messingbürsten Satz Ø 17 mm	054195
V4646M-18	Messingbürsten Satz Ø 18 mm	054201
V4646M-19	Messingbürsten Satz Ø 19 mm	054218



VIGOR No.	Bezeichnung	EAN 4047728+
V4646N-8	Nylonbürsten Satz Ø 8 mm	054225
V4646N-9	Nylonbürsten Satz Ø 9 mm	054232
V4646N-10	Nylonbürsten Satz Ø 10 mm	054249
V4646N-11	Nylonbürsten Satz Ø 11 mm	054256
V4646N-12	Nylonbürsten Satz Ø 12 mm	054263
V4646N-13	Nylonbürsten Satz Ø 13 mm	054270
V4646N-14	Nylonbürsten Satz Ø 14 mm	054287
V4646N-15	Nylonbürsten Satz Ø 15 mm	054294
V4646N-16	Nylonbürsten Satz Ø 16 mm	054300
V4646N-17	Nylonbürsten Satz Ø 17 mm	054317
V4646N-18	Nylonbürsten Satz Ø 18 mm	054324
V4646N-19	Nylonbürsten Satz Ø 19 mm	054331

VIGOR No.	Bezeichnung	EAN 4047728+
V4646S-8	Stahlbürsten Satz Ø 8 mm	053587
V4646S-9	Stahlbürsten Satz Ø 9 mm	053594
V4646S-10	Stahlbürsten Satz Ø 10 mm	053600
V4646S-11	Stahlbürsten Satz Ø 11 mm	054010
V4646S-12	Stahlbürsten Satz Ø 12 mm	054027
V4646S-13	Stahlbürsten Satz Ø 13 mm	054034
V4646S-14	Stahlbürsten Satz Ø 14 mm	054041
V4646S-15	Stahlbürsten Satz Ø 15 mm	054058
V4646S-16	Stahlbürsten Satz Ø 16 mm	054065
V4646S-17	Stahlbürsten Satz Ø 17 mm	054072
V4646S-18	Stahlbürsten Satz Ø 18 mm	054089
V4646S-19	Stahlbürsten Satz Ø 19 mm	054096

Fächerscheiben Satz 115 mm

- Starke Abtragsleistung und müheloser Flächenschliff auf Stahl und Edelstahl ohne zu schmieren. Hinterlässt keine Kratzer auf dem Werkstück
- Universal Fächerscheibe mit hoher Standzeit
- Inhalt: 10 Stück



VIGOR No.		Außen Ø mm	Aufnahme mm	Körnung	1/min	EAN 4047728+
V6810-115K40	10	115	22.23	40	13280	067737
V6810-115K60	10	115	22.23	60	13280	067744
V6810-115K80	10	115	22.23	80	13280	067751

Fächerscheiben Satz 125 mm

- Starke Abtragsleistung und müheloser Flächenschliff auf Stahl und Edelstahl ohne zu schmieren. Hinterlässt keine Kratzer auf dem Werkstück
- Universal Fächerscheibe mit hoher Standzeit
- Inhalt: 10 Stück



VIGOR No.		Außen Ø mm	Aufnahme mm	Körnung	1/min	EAN 4047728+
V6810-125K40	10	125	22.23	40	12200	067782
V6810-125K60	10	125	22.23	60	12200	067775
V7010-125K80	10	125	22.23	80	12200	070690

Trennscheiben Satz

- Freihand-Trennscheiben zur Bearbeitung von Edelstahl und Stahl u.a. für dünne Bleche (z.B. Karosserie), Stahlseile, Profile, Rohre, NE-Metallen und hochwarmfesten Materialien
- Besonders schnittige Scheibe mit guter Standzeit



VIGOR No.		Außen Ø mm	Aufnahme mm	Stärke [mm]	1/min	EAN 4047728+
V6811-76	25	76	22.23	1.6	20100	070287
V6811-115	10	115	22.23	1	13280	067287
V6811-125	10	125	22.23	1	12200	067768

V7106, EAN 4047728071062

Saugheber · einzeln

- Zum Tragen, Heben und Halten von Scheiben, Holzplatten, Spiegeln etc.
- Saugnapf passt sich glatten, staubfreien Oberflächen an
- Lösehebel für einfache Bedienung
- Halt durch Unterdruckaufbau der Saugnäpfe
- Stabile Ausführung aus Aluminium
- Tragkraft maximal: 50 kg

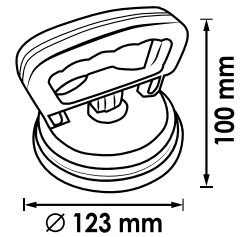

V7107, EAN 4047728071079

Saugheber · doppelt

- Zum Tragen, Heben und Halten von Scheiben, Holzplatten, Spiegeln etc.
- Saugnapf passt sich glatten, staubfreien Oberflächen an
- Lösehebel für einfache Bedienung
- Halt durch Unterdruckaufbau der Saugnäpfe
- Stabile Ausführung aus Aluminium
- Tragkraft maximal: 100 kg

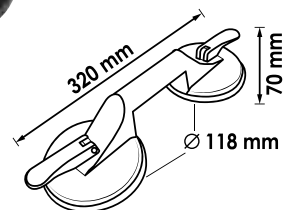

V5531, EAN 4047728055314

Einhand Mini-Saugheber

- Zum Heben, Tragen und Halten
- Justieren und Einsetzen von Spiegelgläsern
- Einhandbedienung durch Hebel
- Tragkraft maximal: 8 kg

Mit Löseknopf

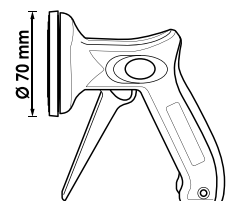

Außen-Entgrater

- Entgraten von Schrauben, Gewinden sowie Anpassen von deformierten Antriebswellen, Spurstangen und Stehbolzen an der Radnabe
- 6,3 mm Sechskant Antrieb
- Drehzahl: 0 – 500 U/Min
- Schneidplättchen aus hochwertigem Wolframstahl gefertigt
- Geeignet für folgende Materialien:
 - Edelstahl
 - Stahl
 - Messing
 - NE-Metalle
 - Kunststoffe

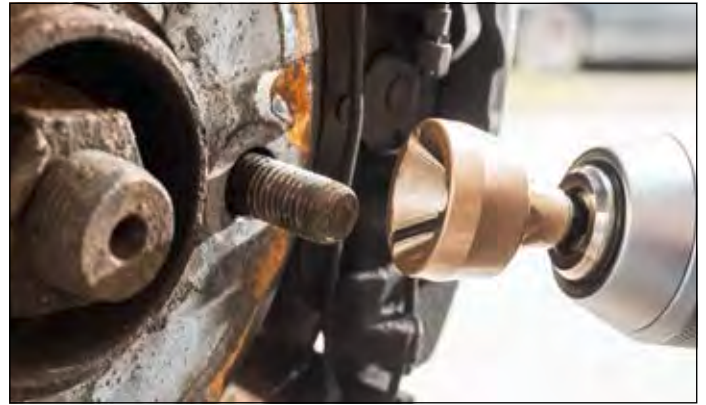
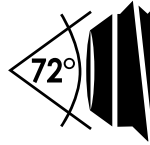

V7402



V7403



VIGOR No.	∅ mm	EAN 4047728+
V7402	3-19	074025
V7403	13-35	074032

V4638, EAN 4047728**046381**

Sicherheits-Laufbühne · Aluminium

- Leicht zu tragen
- Sicherheitsverriegelung an beiden Füßen
- Maximale Tragkraft: 150 kg
- Gewicht: 7,2 kg



Platzsparend
zusammenklappbar

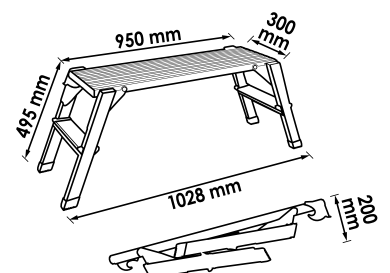



Diagnose / Batterie / Elektrik

Video-Endoskop	252
Elektrik	253, 255
Multimeter	253
Kabelentriegelung	254
Crimpzangen Satz	255

V7500/2, EAN 4047728076210

Video-Endoskop

- Beidseitig 140° schwenkbar
- Analyse und Dokumentation von Schadensbildern an schwer zugänglichen Stellen!
- Sonde: Ø 4,9 mm
- Kamera-Auflösung 640x480 Pixel
- Kamera-Blickwinkel 80°
- 8 dimmbare LED
- Tiefenschärfe 20 – 50 mm
- 89 mm (3,5 Zoll) Bildschirm
- Bildschirm-Auflösung: 320x240 Pixel
- 2 Ah, 3,7 V Li-Ionen-Akku
- Netzteil 2A/5V, USB-Ladekabel und 8 GB Micro SD-Speicherkarte im Lieferumfang enthalten
- Sondenlänge: 1000 mm



NEU

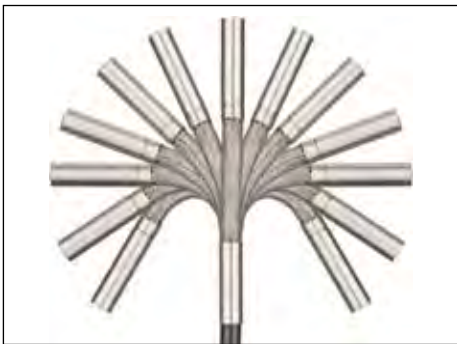

V7500-3.9, EAN 4047728076227

Sonde Ø 3,9 mm · semiflexibel

- Kamera-Auflösung 320x240 Pixel
- Kamera-Blickwinkel 90°
- 2 dimmbare LED
- Tiefenschärfe 10 – 30 mm
- Seitenspiegel · Haken · Magnet im Lieferumfang
- Sondenlänge: 1000 mm

NEU



V4324, EAN 4047728**043243**

Digital Multimeter

- Kompakt und handlich
- Kontrastreiche, einzeilige LCD-Anzeige inklusive Hintergrundbeleuchtung
- 19-stelliger Drehschalter
- Zuverlässige Warnung durch automatische Überlauf- und Polaritätsanzeige zur möglichen Fehlervermeidung
- Aufstellbar inklusive Gummi-Schutzhülle
- Messkabel mit Berührungsschutz
- DC: 200 mV – 600 V
- AC: 200 V – 600 V
- DC: 200 mA – 10 A
- Widerstand: 200 – 2000 Ohm
- Dioden-Tester
- Maximale Anzeige: 1999
- 9 V Batterie (im Gerät)
- Sicherungen:
 - 1 x 250 mA / 250 V
 - 1 x 10 A / 250 V
- Multimeter zur Ruhestromprüfung
- Verwendung mit Messkabel Satz V4326
- Funktionen:
 - Gleich- und Wechselspannung-Messungen
 - Gleich- und Wechselstrom-Messung
 - Widerstandsmessung
 - Diodenprüfung (mit akustischem Signal)
 - Durchgangsprüfung (mit akustischem Signal)
 - Data Hold Funktion



VIGOR No.	Bezeichnung	EAN 4047728+
V4324-1	Sicherungen - 5 Stück	053532
V4324-2	Messkabel für V4324	053549

V1722, EAN 4047728**017220**

Autolichtprüfer

✓ 6 – 24 V

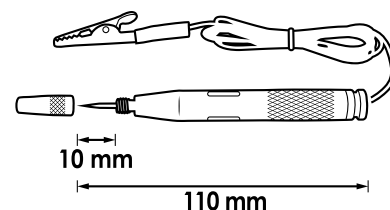

V4451, EAN 4047728**044516**

Kabelentriegelungs-Werkzeug Satz

- Beschädigungsfreies Entriegeln von elektrischen Steckern und Verbindern z.B. bei ABS, Klimasensoren, Radio, PDC, Anhängerkupplungs-Modul etc.
- Schnelle Fehlersuche durch Korrosions- oder Verbindungsdefekte
- Für Rund- und Flachsteckkontakte



**Unentbehrlich für Mechatroniker
und Kfz-Elektriker!**

VIGOR No.	Bezeichnung	Ausführung	EAN 4047728+
V4451-1	Einzelner Kabelentriegeler 1 · BMW · MERCEDES-BENZ · OPEL · VW/AUDI		053693
V4451-2	Einzelner Kabelentriegeler 2 · BMW · JAGUAR · MERCEDES-BENZ · PORSCHE · SAAB · SEAT · ŠKODA		053709
V4451-3	Einzelner Kabelentriegeler 3 · BMW · MERCEDES-BENZ · OPEL · PORSCHE · VW/AUDI		053716
V4451-4	Einzelner Kabelentriegeler 4 · FORD		053723
V4451-5	Einzelner Kabelentriegeler 5 · BMW · FORD · MERCEDES-BENZ · OPEL · PORSCHE · SEAT · ŠKODA · VW/AUDI		053730
V4451-6	Einzelner Kabelentriegeler 6 · BMW · FORD · JAGUAR · OPEL · MERCEDES-BENZ · PORSCHE · SAAB · SEAT · ŠKODA · VW/AUDI		053747
V4451-7	Einzelner Kabelentriegeler 7 · MERCEDES-BENZ		053754
V4451-8	Einzelner Kabelentriegeler 8 · FORD · JAGUAR · MERCEDES-BENZ · OPEL · PORSCHE · VW/AUDI		053761
V4451-9	Einzelner Kabelentriegeler 9 · FORD · MERCEDES-BENZ		053815
V4451-10	Einzelner Kabelentriegeler 10 · MERCEDES-BENZ		053822
V4451-11	Einzelner Kabelentriegeler 11 · BMW · FORD · JAGUAR · MERCEDES-BENZ · OPEL · PORSCHE · SAAB · SEAT · ŠKODA · VW/AUDI		053839
V4451-12	Einzelner Kabelentriegeler 12 · OPEL · RENAULT · ŠKODA · VW/AUDI		053846
V4451-13	Einzelner Kabelentriegeler 13 · FORD · MERCEDES-BENZ		053853
V4451-14	Einzelner Kabelentriegeler 14 · FORD · JAGUAR · PORSCHE		053860
V4451-15	Einzelner Kabelentriegeler 15 · BMW · FORD · MERCEDES-BENZ · OPEL · SEAT · ŠKODA · VW/AUDI		053877
V4451-16	Einzelner Kabelentriegeler 16 · BMW · FORD · JAGUAR · MERCEDES-BENZ · OPEL · PORSCHE · VW/AUDI		053884
V4451-17	Einzelner Kabelentriegeler 17 · BMW		053891
V4451-18	Einzelner Kabelentriegeler 18 · MERCEDES-BENZ		053907
V4451-19	Einzelner Kabelentriegeler 19 · CITROËN · FIAT CHRYSLER · FORD · HONDA · MAZDA · OPEL · MERCEDES-BENZ · MITSUBISHI · PORSCHE · RENAULT · SEAT · TOYOTA · VW/AUDI		053914
V4451-20	Einzelner Kabelentriegeler 20 · FORD		053921
V4451-21	Einzelner Kabelentriegeler 21 · BMW · FORD · JAGUAR · MERCEDES-BENZ · OPEL · PORSCHE · SAAB · SEAT · ŠKODA · VW/AUDI		053938
V4451-22	Einzelner Kabelentriegeler 22 · HONDA · OPEL · TOYOTA · VW/AUDI		053945
V4451-23	Einzelner Kabelentriegeler 23 · OPEL · VW/AUDI		053952



Crimpzangen Satz Elektrik



V2499, EAN 4047728024990

Crimpzangen Satz

- Fünf austauschbare Crimp-Einsätze:
- Crimp-Einsatz A: für isolierte Kabelschuhe 0,5 – 6,0 mm² (rot, blau, gelb)
- Crimp-Einsatz B: für geschlossene, unisolierte Kabelschuhe 1,5 · 2,5 · 6,0 · 10 mm²
- Crimp-Einsatz C: für offene, unisolierte Kabelschuhe 0,5 – 6,0 mm² (Breite bis 6,3 mm)
- Crimp-Einsatz D für Ader-Endhülsen mit und ohne Kragen 0,5 – 4,0 mm²
- Crimp-Einsatz F: für Ader-Endhülsen über 6,0 mm²

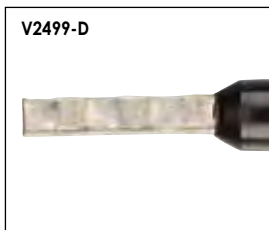
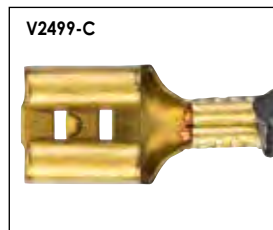

Ersatzteile

VIGOR No.	Bezeichnung	Ausführung	EAN 4047728+
V2499-A	Crimp-Einsatz A: für isolierte Kabelschuhe von 0,5 – 6,0 mm ² (rot · blau · gelb)		053440
V2499-B	Crimp-Einsatz B: für geschlossene · unisolierte Kabelschuhe von 1,5 · 2,5 · 6,0 · 10 mm ²		053457
V2499-C	Crimp-Einsatz C: für offene · unisolierte Kabelschuhe von 0,5 – 6,0 mm ² (Breite bis 6,3 mm)		053464
V2499-D	Crimp-Einsatz D: für Aderendhülsen mit und ohne Kragen von 0,5 – 4,0 mm ²		053471
V2499-F	Crimp-Einsatz F: für Aderendhülsen über 6,0 mm ²		053488

V2499-A, EAN 4047728053440
Crimp Einsatzbacken



V7548, EAN 4047728075480

Batterie-Tester

- Prüfung des Status von Batterie und Ladesystemen (12- und 24 V)
- Geeignet für Start-Stopp Batterien
- Für Pkw, Motorräder, Transporter und Boote
- Funktionen:
 - Statusbericht von Batterie und Ladesystemen
 - Belastungsanzeige beim Startvorgang des Motors
 - Identifizierung von defekten Batterien
 - Optionaler Druck der Testergebnisse
- Mobiler Einsatz, ohne Stromzufuhr
- Ermöglicht die Prüfung im ein- und ausgebauten Zustand
- Benutzerfreundliche Bedienung
- Verpolungsschutz verhindert Kurzschluss
- Thermopapier-Rolle im Lieferumfang enthalten
- Klemmkabel-Länge: 600 mm



V7548-1, EAN 4047728075527
Thermopapier-Rolle

- Breite: 56 mm
- Lauflänge: 5 m
- Durchmesser: 29 mm
- Hülsendurchmesser: 15 mm



Motor / Kühlung / Klima

Motor-Werkzeuge

257–259

Kühlsystem-Diagnose

260–262

Turbosystem-Diagnose

263–264

Kompressions- und Druckverlusttester

265–267



V5676, EAN 4047728**056762**

Lambdasonden Satz

- Lambdasonden, Einspritzdüsen sowie Theroschalter in schwer zugänglichen Bereichen

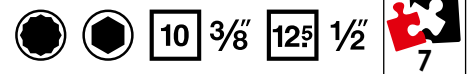

● SW 22 mm

10 3/8

80

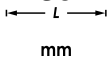

mm



● SW 22 mm

10 3/8

90

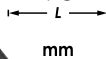

mm



● SW 27 mm

10 3/8

74

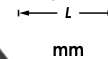

mm



● SW 22 mm

125 1/2



● SW 29 mm

125 1/2

90

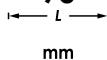

mm



○ SW 27 mm

125 1/2

83

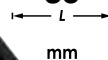

mm



● SW 22 mm

10 3/8



V6741, EAN 4047728**067416**

Abzieher Satz für Zündspulen

- Professionelles und beschädigungsfreies Demontieren von Zündspulen und Zündspulen-Leisten an VAG und OPEL- Motoren
- Aufstecken und anschließendes Abziehen ermöglicht gleichmäßiges Demontieren des Zündmoduls
- Paarweise Verwendung empfohlen
- Größte Marktdeckung
- 2 Zündmodul-Abzieher für:
 - CHEVROLET/GMC Aveo Cruze · OPEL/VAUXHALL Adam · Agila B · Astra J · Cascada Combo · Corsa D · Meriva B · Mokka · Zafira Tourer
 - Motoren:
 - 1 Liter A10XEP (LDB), 1,2: A12XEL (LWD) A12XER (LDC), 1,4: A14XEL (L2Z) A14XER (LDD) LDU
 - 1,4 Liter (T) A14NEL (LUH) A14NET (LUJ) Twinport / ecoFLEX Motoren
 - OPEL 3- bzw. 4-Zylinder Benzin-Einspritzmotoren z.B. bei Agila A · Astra F · Astra G · Astra H · Astra J · Calibra Combo · Corsa B · Corsa C · Corsa D · Frontera A · Frontera B · Insignia · Meriva A · Meriva B · Omega B · Signum · Tigra A · Tigra B · Vectra B · Vectra C · Zafira A · Zafira B
 - Motorcodes: 20LEH · 2HO · A10XEP · A14NEL · A14NET · A14XER · A16LET · A16XER · A18XER · C22SEL · LDD · LDE · LLU · LUH · LUJ · X14NZ · X14SZ · X14XE · X16SZR · X16XE · X16XEL · X18XE · X20SE · X20XE · X22SE · X22XE · Y22SE · Z10XEP · Z12XE · Z12XEP · Z14XE · Z14XEL · Z14XEP · Z16LEL · Z16LER · Z16LET · Z16XE · Z16XER · Z16YNG · Z18XE · Z18XER · Z20LER
 - 4 Zündklaven:
 - TYP A (26 mm): z.B. VW Golf · Bora · Beetle · Lupo · Passat · Touran · T4 · AUDI A2
 - TYP B (18 mm): Bora · Golf · Passat · Sharan · Touareg · Phaeton · T5
 - TYP C (43 mm): 8 und 12 Zylinder Motoren wie Phaeton u.a.
 - TYP D (35 mm): Direkteinspritzer VW Golf · Touran · Passat und Eos sowie AUDI A4 und A6



V6740, EAN 4047728**077774**

Abzieher Satz für Zündspulen · VAG

- Sicheres und beschädigungsfreies Entfernen von Zündspulen mit Leistungsendstufe gemäß Herstellervorgabe, z.B. an 1,0 l · 1,0 l TSI · TFSI · TGI · GTI · CNG · 1,2 l TSI · 1,4 l 25 · 30 · 35 · 40 · 45 TSI · TFSI · TGI · CNG · GTE · Mild Hybrid · e-Hybrid · 1,6 l · 1,6 l SRE · MPI 2,0 l GTI
- Motoren u.a. verbaut in folgenden Modellen:
 - AUDI A1 · A3 · A4 · A5 · Q2 · Q3
 - SEAT Alhambra · Arona · Ateca · Cupra Formentor · Ibiza · León · Mii · Tarraco · Toledo
 - ŠKODA Citigo · Fabia · Kamiq · Karoq · Kodiaq · Octavia · Rapid · Scala · Super · Yeti
 - VW Arteon · Beetle · Caddy · Golf 6-8 · Jetta 4-7 · CC · Passat B8 · Polo 5-6 · Scirocco · Sharan · T7 · Taigo · Tiguan · Touran · T-Cross · T-Roc · Up!
- Demontage von beiden Zündspulversionen möglich:
 - 04C.905.110.J Bj. →2017
 - 04E.905.110.K Bj. 2017 →



V3381, EAN 4047728**033817**

Schlauchschellen Satz

- Für Schläuche mit \varnothing bis 45 mm



V3571, EAN 4047728**035712**

Keilrippenriemen Werkzeug

- Glasfaserverstärktes Nylon
- Einfachste Handhabung auf dem Markt
- Keine Anpassung notwendig
- Für alle elastischen Riemenarten: Klimaanlage, Lichtmaschinen sowie einfache und doppelte Riemenscheiben



Montage

Demontage



V1963N, EAN 4047728060097

Kühlsystem-Diagnose Satz

- Pkw Diagnose
- Kompletter Satz für Servicearbeiten am Kühlsystem und an der Heizung
- Umfangreiche Adapterauswahl, für Fahrzeuge mit wassergekühlten Motoren
- 3 Funktionen: Kühler abdücken (Kontrolle auf Undichtigkeiten) · befüllen · reinigen
- Druckverlustkontrolle über Manometer
- Befüllen erzeugt Vakuum im Kühlkreislauf (Vorteil: Blasenfreies Einsaugen der Flüssigkeit)
- Problemlose Befüllung auch größerer Motoren ohne thermische Schwachpunkte
- Füllsystem universell adaptierbar durch konischen Gummianschluss-Stutzen
- Messbereich: 0 – 2,5 bar
- Inklusive 90° Adapter für schwer erreichbare Stellen



**Größte Marktabdeckung,
29-teilig**





VIGOR No.	Bezeichnung	Ausführung	EAN 4047728+
V1963-1	Befüllschlauch Kühflüssigkeit mit Anschluss		053228
V1963-3	Prüfadapter schwarz R123 · R124		053242
V1963-4	Prüfadapter blau R123 · R125		053259
V1963-5	Bajonett Adapter · Ø 38 mm		053266
V1963-6	Bajonett Adapter · Ø 42 mm		053273
V1963-7	Bajonett Adapter · Ø 50 mm		053280
V1963-8	Adapter · M 42x2,5		053297
V1963-9	Adapter · M 42x3,0		053303
V1963-10	Adapter · M 45x3,0 hohl		053310
V1963-11	Adapter · M 46x3,0		053327
V1963-12	Adapter · M 48x2,5		053334
V1963-13	Adapter · M 48x4,0		053341
V1963-14	Adapter · M 50x2,5		053358
V1963-15	Adapter · M 50x2,5 hohl		053365

VIGOR No.	Bezeichnung	Ausführung	EAN 4047728+
V1963-16	Adapter · M 50x3,0		053372
V1963-17	Adapter · M 52x3,0		053389
V1963-18	Adapter · M 60x4,0		053396
V1963-19	Adapter · M 34x3,0		053402
V1963-20	Adapter · M 58x3,0		053419
V1963-21	Adapter · M 62x3,0		053426
V1963-22	Thermometer		053433
V1963-23	Adapter · M 45x3,0		060103
V1963-24	Adapter 90°		060110
V1963-25	Universaladapter / Konus		060127
V4257	Kühlsystem-Schraubadapter · M 45x3,0 mm		042574
V4202	Vakuum-Befüllleinheit		042024
V4258	Kühlsystem-Schraubadapter · M 52,5x3,0 mm		042581
V3729	Handpumpe mit Manometer		037297

V5660, EAN 4047728056601

Kupplung 4,4 mm auf 7,2 mm

- Adaptierung Handpumpe V3729 auf Fremdfabrikate, z.B. Klann Adapter / Systeme (4,4 mm auf 7,2 mm)



V5922, EAN 4047728059220

Kupplung 7,2 mm auf 4,4 mm

- Adaptierung VIGOR Kühlsystem Adapter auf z.B. Klann Handpumpen / Systeme (7,2 mm auf 4,4 mm)



V2459N, EAN 4047728075541

Refraktometer

- Schnelle, präzise Kontrolle des Frostschutzgehaltes an Kühl- und Scheibenwaschflüssigkeit sowie zur Prüfung der Batteriesäuredichte und AdBlue
- Einstellbares Okular mit Gummi-Augenaufgabe
- Linke Skala: Batteriesäuredichte Messbereich 1100 – 1400 sg / Auflösung 0,01 sg
- Mittlere Skala: Frostschutz auf Basis Propylenglykol G 13 Messbereich 0° C bis -50° C / Auflösung 5° C sowie Frostschutz auf Basis Ethylenglykol G 11 / G 12 Messbereich 0° C bis -50° C / Auflösung 5° C
- Rechte Skala oben: AdBlue (VRA) Harnstoffgehalt Messbereich 30% – 35% / Auflösung 0,1%
- Rechte Skala unten: Frostschutz Scheibenwaschflüssigkeit SRF 1 Messbereich 10° C bis -40° C / Auflösung 1° C
- Kunststoffbox mit Weichschaum-Einlage
- Inhalt:
 - 1 x Refraktometer
 - 1 x Pipette

Anwendbar u.a. für Kühl- und Scheibenwasser, Batteriesäure und AdBlue



V4192, EAN 4047728041928

Turbosystem-Abdrücker Satz für Klicksysteme

- Schnelle Diagnose der Ladeluft-Systeme in neuen Fahrzeuggenerationen, bei denen Luftrohre mit Klicksystem verbunden werden
- Durchführung der Dichtheitsprüfung anhand von Geräuscentwicklung, Lecksuchspray oder Druckabfall
- Inhalt: 6 Stopfen-Paare 31 · 38 · 46 · 51 · 56 · 61 mm

Ermöglicht zeitsparende und fachgerechte Ermittlung von undichten Ladeluftschläuchen



V4233, EAN 4047728042338

Manometer für Turbosystem-Abdrücker Satz

Für V3595 · V4192 und V4331



V4304, EAN 4047728**043045**

Turbosystem Abdrücker Satz für Kfz

- Schnelle Diagnose des Ladeluftsystems
- Zeitsparende, fachgerechte Ermittlung von undichten Ladeluftkühlern und nicht sichtbaren Rissen in Ladeluftschläuchen
- Inhalt:
1 Druckschlauch mit Manometer und Ausgleichsventil
6 Paar abgestufte Adapter:
31/38 · 46/51 · 55/60 · 65/70 · 75/80 · 85/90 mm



Inklusive Manometer



V4305, EAN 4047728**043052**

Adapter 31/38 mm

- Nutzung mit Manometer V4233 zum Test des Turbosystems
- Als z.B. Erweiterung des Turbosystem-Abdrücker Satz V3595



V4306, EAN 4047728**043069**

Adapter 46/51 mm

- Nutzung mit Manometer V4233 zum Test des Turbosystems
- Als z.B. Erweiterung des Turbosystem-Abdrücker Satz V3595



V4461, EAN 4047728**044615**

Kompressions- und Druckverlusttester Satz

- Professionelle Prüfung von Kompression oder Druckverlust für die meisten Pkw-, Lkw-, Motorrad-, Bus-, Agrar- und Boots- Motoren sowie Hdi- TDCI- und Pumpe-Düse- Motoren
- Für Diesel- und Benzinmotoren
- Enthält Glühkerzenadapter für z.B.: ALFA ROMEO · BMW · CHRYSLER · DAEWOO · FIAT · FORD · HYUNDAI · ISUZU · LANDROVER · MAZDA · MERCEDES-BENZ · MITSUBISHI · NISSAN · OPEL · PSA · RENAULT · SAAB · SUZUKI · TOYOTA · VAG · VAUXHALL · Volvo · etc.
- Zündkerzenadapter M 10 · M 12 · M 14 · M 18
- Kompressions-Druckprüfer maximal 50 bar
- Schnellkupplungen in gerader und abgewinkelter Ausführung
- Einspritzdüsen Adapter M 20 · M 22 · M 24 sowie für FORD Stanadyne Injektoren



Für Diesel- und Benzinmotoren



V4325, EAN 4047728**043250**

Vakuum- und Druckpumpen Satz

- Überprüfen von Druck- und Unterdrucksystemen
- Ladedruck
- Unterdruck-Magnetventilen
- MAP-Sensoren
- Tankbelüftungen
- Bremsleitungs-Systeme
- Inklusive umfangreichem Adapter Sortiment



**Auch geeignet für
Bremsleitungs-Systeme**



Anzeigebereich: -1 bis 4 bar
 Unterdruckanzeige-Bereich: von -1 bis 0 bar
 Maximaler Druck: bis 3 bar
 Maximaler Unterdruck: bis 0,7 bar



Injektorschacht Reinigungs Satz



V4941N, EAN 4047728**077293**

Injektorschacht Reinigungs Satz

- Beseitigung von Rußrückständen, Partikeln an HDI-, Diesel-Direkteinspritzung und Common-Rail Motoren mit Bosch- und Delphi-Injektoren
- Inklusive Verschlussstopfen gegen Brennraum-Verunreinigungen
- Zentrierkronen zur genauen Führung

Fachgerechtes Reinigen des Injektorschachtes, der Injektorspitze und Düsenzapfenöffnung



NEU



VIGOR No.	Bezeichnung	Ausführung	EAN 4047728+
V4941N-1	Dichtring-Spreizer		077415
V4941N-2	Reibahle		077422
V4941N-3	Fräserkopf · lang · Rändelgriff		077439
V4941N-4	Flexibler Adapter		077446
V4941N-5	Fräserkopfhalter · kurz		077453
V4941N-M5	Schutzkappen M5x0,8x15 mm		077460
V4941N-BL	Bürste · lang		077576
V4941N-BK	Bürste · kurz		077569
V4941N-19T	Sechskant · T-Griff, 19 mm		077521
V4941N-10	Halter Schutzkappe M5		077477
V4941N-11	Halter Reinigungsbürste		077514
V4941N-245	Adater		077552
V4941N-20	Adapter		077538
V4941N-22	Adater		077545
V4941N-R1	Fräserkopf 120 Grad		077583
V4941N-R2	Fräserkopf 90 Grad		077590

VIGOR No.	Bezeichnung	Ausführung	EAN 4047728+
V4941N-R3	Fräserkopf 90 Grad		077606
V4941N-R4	Fräserkopf 90 Grad		077613
V4941N-R5	Fräserkopf 120 Grad		077620
V4941N-R6	Fräserkopf 90 Grad		077637
V4941N-R7	Fräserkopf 120 Grad		077644
V4941N-R8	Fräserkopf 90 Grad		077651
V4941N-R9	Fräserkopf 90 Grad		077668
V4941N-R10	Fräserkopf 90 Grad		077675
V4941N-R11	Fräserkopf 90 Grad		077682
V4941N-R12	Fräserkopf 120 Grad		077699
V4941N-R13	Fräserkopf 90 Grad		077705





Öldienst

Öl-Messstäbe	269
Ölfilter-Spannschlüssel	270–271
Öl-Pumpen und Einfüllgeräte	272–273

V5048, EAN 4047728050487

Tankgeberschlüssel · universal

- Betätigung Verschlussring Tankgeber
- Für beengte Platzverhältnisse

Fachgerechtes und
zeitsparendes Arbeiten
ohne Beschädigung
des Verschlussringes

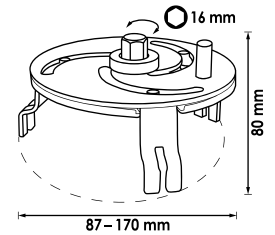

V2112, EAN 4047728021128

Ölmesstäbe Satz MERCEDES-BENZ

- Messen des Motor- und Automatikgetriebe-Ölstandes
- Unverzichtbar nach Ölwechsel (Fahrzeugauslieferung werksseitig ohne Messstäbe, sondern nur mit Verschlussstopfen)

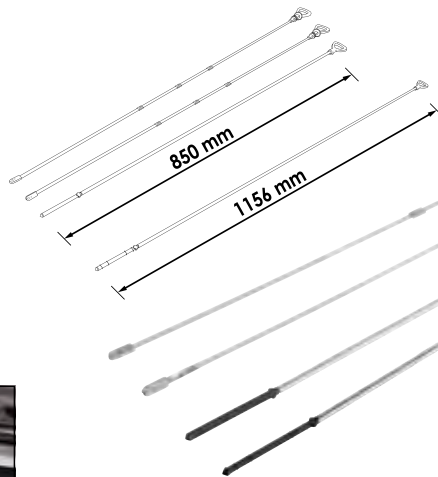

Manuell

Automatik



V2645, EAN 4047728026451

Ölmesstab AUDI

- Kontrolle des Füllstands nach Ölwechsel und anschließendem Vergleich mit Displayanzeige
- Für Modelle mit Ölstandsanzeige im Display (kein Peilstab am Motor)
- Hilfreich nach Tausch des Ölsensors oder Kalibrierung der Anzeige im Fahrerdisplay (vergleichbar T40178)
- Anwendung: u. a. für AUDI A4 / A5 / A6 mit Motoren 1,8 · 2,0 TFSI / 3,0 · 3,2 FSI / 2,0 · 2,7 · 3,0 TDI

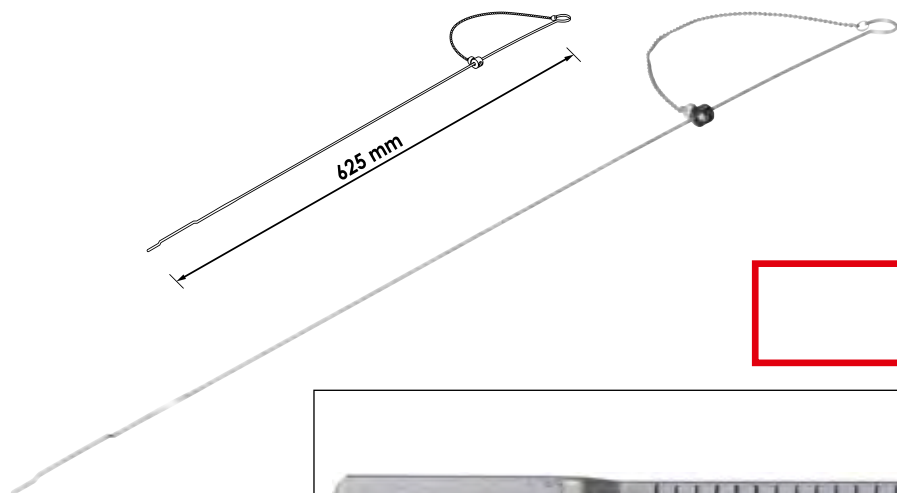

V2511N, EAN 4047728068239

Ölfilter-Bandschlüssel

- Ein- und Ausbau von Ölfiltern
- Stufenlos verstellbar
- Einstellung auf Filter-Ø durch Drehen am Griffende
- Ergonomischer Handgriff

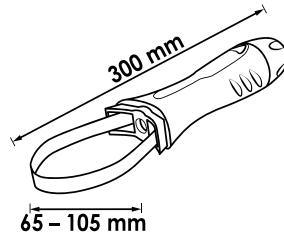

V2521, EAN 4047728025218

Ersatz-Spannband

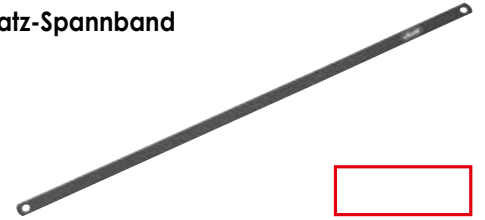

V1281, EAN 4047728012812

Ölfilterkralle

- Antrieb wahlweise: $\frac{1}{2}$ Innenvierkant oder SW 21 mm Außensechskant

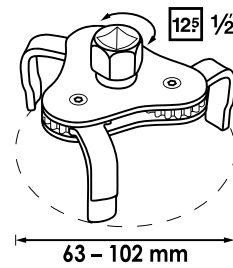

12 5/8



V7385, EAN 4047728077194

Getriebe Werkzeug Satz · MERCEDES-BENZ · 9G-Tronic

- Ablassen und Befüllen des Getriebeöls an 9-Gang Tronic Automatikgetriebe mit Kennung 725 (725589029000 · 725589009000)
- Alle notwendigen Werkzeuge für den Ölwechsel
- Ablassschlüssel zum Einstellen des Steigrohres
- Inhalt:
 - Ölfilter-Adapter (Verwendung mit Öl Einfüllgerät V4385N)
 - Multifunktions-Ölablassschlüssel
 - Ölablassschrauben-Schlüssel



NEU



Ölfilter-Spannschlüssel · universal

- Mechanische Arretierung des Ölfilterschlüssels vereinfacht das nachträgliche Ansetzen der Umschaltknarre an dem Ölfilterschlüssel
- Bei Rückbewegung der Umschaltknarre bleibt der Ölfilter-Spannschlüssel stets unter Spannung
- Stufenlos verstellbar
- Einsatz mittels Schraubenschlüssel SW 21 mm oder $\frac{1}{2}$ Umschaltknarre
- Optimaler Halt beim Lösen des Ölfilters durch linksverzahnte Backen
- Für schwer zugängliche Filtergehäuse
- Anwendung im Rechts- und Linksbetrieb ermöglicht Befähigung Schraubverbindung

SW 21 mm

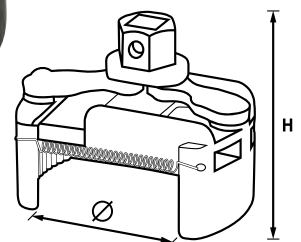

Durchgängige Verzahnung



VIGOR No.	Höhe	■	Ø mm	EAN 4047728+
V4413	60 mm	● 21 mm, $\frac{1}{2}$	60–80	044134
V4414	70 mm	● 22 mm, $\frac{1}{2}$	80–115	044141
V4415	105 mm	● 24 mm, $\frac{1}{2}$	115–140	062114



V4701, EAN 4047728**073844**

Vakuumpumpe · Mini

- Manuelle Vakuumpumpe zum Absaugen und Einfüllen von Fahrzeugflüssigkeiten
- Gute Ablesbarkeit des Füllstands
- Genaue Dosierung und leichte Handhabung durch ergonomisches Design
- Fassungsvermögen: 100 ml
- Inklusive Gummischlauch mit Auslaufstopp-Kappe
- Für folgende Flüssigkeiten:
 - Dieselkraftstoffe
 - Benzin
 - Bremsflüssigkeit
 - Frostschutz
 - Motoröl
 - Getriebeöl
 - Servolenkungslöl

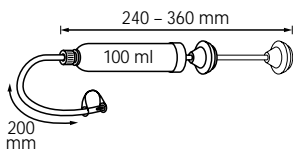

V4369, EAN 4047728**043694**

Vakuumpumpe

- Ansaugen und Umfüllen von Kraftstoffen, Ölen und anderen Flüssigkeiten
- Fassungsvermögen: 350 ml
- Für u. a. folgende Flüssigkeiten:
 - Dieselkraftstoffe
 - Benzin
 - Bremsflüssigkeit
 - Frostschutz
 - Motoröl
 - Getriebeöl
 - Servolenkungslöl
- Inhalt:
 - 1 x Handpumpe 350 ml
 - 1 x PVC-Schlauch \varnothing 9,8 x 300 mm
 - 1 x Silikonschlauch \varnothing 11 x 300 mm
 - 1 x Tropfstopfen
 - 1 x Universal Adapter

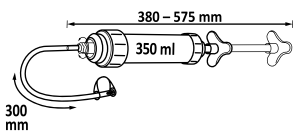

V4201, EAN 4047728**042017**

Vakuumpumpe

- Manuelle Vakuumpumpe zum Absaugen und Einfüllen von Fahrzeugflüssigkeiten
- Vorbefüllen des Kraftstofffilters, bei Fahrzeugen ohne Vorfilterpumpe z.B. beim 2,0 l TDI FORD Galaxy und Mondeo
- Fassungsvermögen: 1,5 l
- Für folgende Flüssigkeiten:
 - Dieselkraftstoffe
 - Benzin
 - Bremsflüssigkeit
 - Frostschutz
 - Motoröl
 - Getriebeöl
 - Servolenkungslöl

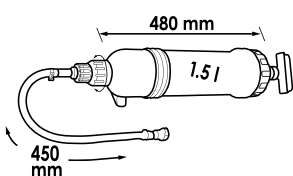

Geeignet für alle Kraftstoffe



V4201-1, EAN 4047728**056588**
Dichtungssatz für V4201



Irrtümer vorbehalten

V4385N, EAN 4047728072601

Öl-Einfüllgerät mit Adapter Satz

- Befüllen von Getrieben und Differentialen mit Öl
- Inklusive Ölwanne und 16 Adapter für Fahrzeuge mit extrem beengten Bauräumen

*Neue, verbesserte
Satzzusammenstellung*



VIGOR No.	Bezeichnung	Ausführung	EAN 4047728+
V3681	Adapter FORD · mit Gewindeanschluss		036818
V3682	Adapter BMW · abgelenkt		036825
V3683	Adapter VAG · kurz · abgelenkt		036832
V3684	Adapter VAG · lang · abgelenkt		036849
V3685	Adapter VAG · gerade · mit Gewindeanschluss		036856
V3686	Adapter MERCEDES-BENZ · 7-Gang Automatik		036863
V3687	Adapter VAG · DSG Direktschaltgetriebe		036870
V3688	Adapter VAG · CVT stufenlose Automatik		036887
V3689	Adapter Volvo · gerade		036894
V3690	Adapter ŠKODA · M 18x1,5 mm		036900
V3691	Adapter VW · Passat		036917
V4113	Adapter TOYOTA · LEXUS · 18x1,5		041133
V4114	Adapter Infiniti · 7 Speed M 8x1,0		041140
V4115	Multifunktions Adapter		041157
V4383	Adapter NISSAN · Juke M 12x1,25 mm		043830
V4384	Adapter MINI Cooper · M 14x1,5 mm		043847
V7285	Adapter NISSAN · Hybrid · M 10x1,5		072854
V7286	Adapter GM · M 12x1,75		072861
V7287	Adapter ŠKODA · M 18x1,5		072878
V7288	Adapter VAG · 7-Gang Doppelkupplung		072885



Bremsen

Bremswartung und Entlüftung

275–277

Bremskolben-Rückstellwerkzeuge

278–281

Bremsscheiben-Werkzeuge

282–283

Bördelgeräte

284–286

Inspektions-Werkzeuge

287–291

V4411, EAN 4047728**044110**

Bremsentlüfter Satz 3 l · manuell

- Entlüftung von Brems- und Kupplungssystemen
- Betriebsdruck: max 1,4 bar
- Manometer-Bereich: 0 – 2 bar
- Ablassen des Drucks durch integriertes Druckablassventil
- Inhalt:
 - 3 Liter Tank
 - E20 Euro Adapter
 - Universal Adapter mit Kette
 - Verbindungs-Schlauch mit Schnellanschluss
 - Auffangbehälter mit Anschlussnippel für Bremssysteme

Besonders geeignet für mobile Anwendung durch manuelle Druckaufbau-Funktion



**Fassungsvermögen:
3 Liter**



V4668, EAN 4047728**046688**

Bremsflüssigkeit-Behälter

- Auffangbehälter zum Entlüften von Brems- und Kupplungssystemen
- Silikonschlauch, Länge: 550 mm
- Im Satz V4411 enthalten

Geeignet für alle gängigen Entlüfterventile



**Fassungsvermögen:
0,7 Liter**



V4381, EAN 4047728**043816**

Adapter für Bremssysteme

- In Verbindung mit konventionellen Bremswartungs-Geräten
- Deckel aus langlebigem Aluminium
- Inhalt:
 - Adapter E 20 W für schwer zugängliche Ausgleichsbehälter, für fast alle europäischen Fahrzeuge
 - Adapter G 75 für ISUZU · MITSUBISHI · PROTON · SUBARU · SUZUKI · Volvo · KIA
 - Adapter B 35 für CHRYSLER · FORD · NISSAN · SUBARU · HYUNDAI
 - Universal Adapter mit Kettenbefestigung

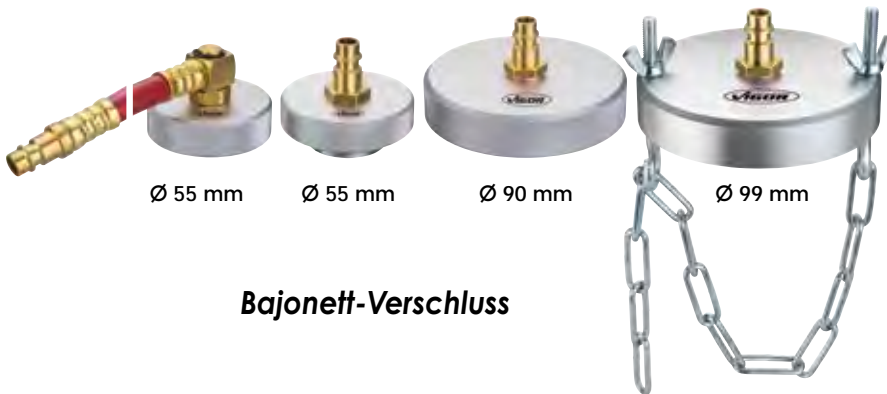

Ø 55 mm

Ø 55 mm

Ø 90 mm

Ø 99 mm

Bajonett-Verschluss

Einfache und nützliche Ergänzung zur Verwendung von Wartungsgeräten an nahezu allen Fahrzeugen

VIGOR No.	Bezeichnung	Ausführung	EAN 4047728+
V4381-1	Adapter E 20 W für Bremswartungs-Systeme		046930
V4381-2	Adapter G 75 für Bremswartungs-Systeme		046947
V4381-3	Adapter B 35 für Bremswartungs-Systeme		046954
V4381-4	Universal Adapter mit Kettenbefestigung für Bremswartungs-Systeme		046961



V7471, EAN 4047728074711

Bremsentlüfter Satz

- Entlüften von Bremsleitungssystemen, Wechsel der Bremsflüssigkeit ohne Demontage der Räder
Auch zum Entlüften von Kupplungssystemen
- Komfortable Anwendung dank ergonomischer Spezialratsche
- Einfaches Öffnen und Schließen des Bremsnippels dank spezieller Gelenk-Ratsche
- Garantiert schneller Zugang zum Bremsennippel auch bei montiertem Rad
- Gute Kraftübertragung durch anwendungsoptimierten Handgriff
- Winkel-Kupplung in 90° Ausführung mit Rückstoßventil und Verdrehenschutz
- Rückstoßventil verhindert Eindringen von Luft in das System



10 – 11 mm



VIGOR No.	Bezeichnung	Ausführung	SW	EAN 4047728+
V7471-A	90° Universal Adapter		-	074889
V7471-T	Silikon Schlauch		-	074896
V7471-TL	Gummischlauch · lang		-	074865
V7471-TS	Gummischlauch · kurz		-	074858
V7471-W	Bremsentlüfter-Ratsche 14 mm Sechskant		-	074872
V7471L-10	Steckschlüssel · lang · 10 mm		10 mm	074834
V7471L-11	Steckschlüssel · lang · 11 mm		11 mm	074827
V7471S-10	Steckschlüssel · kurz · 10 mm		10 mm	074759
V7471S-11	Steckschlüssel · kurz · 11 mm		11 mm	074766

Optionales Zubehör (nicht im Lieferumfang enthalten)

VIGOR No.	Bezeichnung	Ausführung	SW	EAN 4047728+
V7471S-7	Steckschlüssel · kurz · 7 mm		7 mm	074728
V7471S-8	Steckschlüssel · kurz · 8 mm		8 mm	074735
V7471S-9	Steckschlüssel · kurz · 9 mm		9 mm	074742
V7471S-12	Steckschlüssel · kurz · 12 mm		12 mm	074773
V7471L-7	Steckschlüssel · lang · 7 mm		7 mm	074780
V7471L-8	Steckschlüssel · lang · 8 mm		8 mm	074797
V7471L-9	Steckschlüssel · lang · 9 mm		9 mm	074803
V7471L-12	Steckschlüssel · lang · 12 mm		12 mm	074841

V7471/17, EAN 4047728077187

Bremsentlüfter Komplet Satz

- Entlüften von Bremsleitungssystemen, Wechsel der Bremsflüssigkeit ohne Demontage der Räder
Auch zum Entlüften von Kupplungssystemen
- Komfortable Anwendung dank ergonomischer Spezialratsche
- Einfaches Öffnen und Schließen des Bremsnippels dank spezieller Gelenk-Ratsche
- Garantiert schneller Zugang zum Bremsennippel auch bei montiertem Rad
- Gute Kraftübertragung durch anwendungsoptimierten Handgriff
- Winkel-Kupplung in 90° Ausführung mit Rückstoßventil und Verdrehenschutz
- Rückstoßventil verhindert Eindringen von Luft in das System
- Steckschlüssel: SW 7 – 12 mm in kurzer und langer Ausführung im Lieferumfang



7 – 12 mm



V3760N, EAN 4047728066310

Bremskolben-Rückstellwerkzeug Satz

- Links- und rechtsdrehende Kolben
- Inklusive 4 Spezial Steckschlüssel-Einsätze
- Zurücksetzen durch Drücken und zeitgleiches Drehen des Bremskolbens
- Nummerierung der Adapterplatten ermöglicht detaillierte Zuordnung
- Aufnahmen der Spindeln sind magnetisch, ermöglicht komfortables Arbeiten
- Inhalt:
 - 2 Spindeln (links- und rechtsdrehend)
 - 2 Winkelschlüssel (6 und 7 mm)
 - 2 Splinttreiber
 - 3 austauschbare Rückhalteplatten
 - 36 Rückhalteplatten und Adapter
 - 4 Spezial Bremsverschraubung-Einsätze
 - 1 Spindelfett
- Adapter ermöglichen Einsatz auch bei stark abgefahrenen Belägen sowie den Zusammenbau der Rücksteller im Bremsattel



VIGOR No.	Bezeichnung	Ausführung	■	∅	Zapfendurchmesser	Zapfenhöhe	SW	EAN 4047728+
V3760-1	Adapterplatte 1		-	-	-	-	-	067164
V3760-2	Adapterplatte 2		-	51	6	9	-	066853
V3760-3	Adapterplatte 3		-	55	-	-	-	067201
V3760-4	Adapterplatte 4		-	32	5	2,5	-	066631
V3760-5	Adapterplatte 5		-	36	6	4	-	066648
V3760-6	Adapterplatte 6		-	42	6	4	-	066655
V3760-7	Adapterplatte 7		-	42	6	2	-	066662
V3760-11	Adapterplatte 11		-	-	-	-	-	066679
V3760-12	Adapterplatte 12		-	-	-	-	-	066686
V3760-A	Adapterplatte A		-	41	6	4	-	066693
V3760-B	Adapterplatte B		-	38	10	3	-	066709
V3760-C	Adapterplatte C		-	38	4	3	-	066716
V3760-D	Adapterplatte D		-	51	6	3	-	066723
V3760-E	Adapterplatte E		-	42	5	3	-	066730
V3760-F	Adapterplatte F		-	36	6	4	-	066747
V3760-G	Adapterplatte G		-	32	4	3	-	066754
V3760-J	Adapterplatte J		-	44	6	3	-	066761

Bremskolben-Rückstellwerkzeuge



VIGOR No.	Bezeichnung	Ausführung	■	∅	Zapfendurchmesser	Zapfenhöhe	SW	EAN 4047728+
V3760-K1	Adapterplatte K1		-	54	10	7	-	066778
V3760-K2	Adapterplatte K2		-	45	6	4	-	066785
V3760-M	Adapterplatte M		-	32	6	3	-	066792
V3760-P	Adapterplatte P		-	38	4	4,5	-	066808
V3760-Q	Adapterplatte Q		-	32	5,5	3	-	066815
V3760-R	Adapterplatte R		-	36	6	4	-	066822
V3760-S	Adapterplatte S		-	38	4	3	-	066839
V3760-T	Adapterplatte T		-	28	5	4	-	066952
V3760-V	Adapterplatte V		-	40	4	2,5	-	066969
V3760-X	Adapterplatte X		-	-	-	-	-	066976
V3760-Z	Adapterplatte Z		-	30	4	4,5	-	066983
V3760-8	Adapterplatte 8		-	48	5,5	3	-	066990
V3760-9	Adapterplatte 9		-	54	5,5	3	-	067003
V3760-0	Adapterplatte 0		-	63,5	5,5	3	-	067010
V3760-0-DISC	Adapterplatte 0-DISC		-	59	-	-	-	067027
V3760-K	Adapterplatte K		-	54	8	4	-	067034
V3760-N	Adapterplatte N		-	32	12	5	-	067041
V3760-IV	Adapterplatte IV		-	42	6	9	-	067058
V3760-H6	Winkelschraubendreher H6		-	-	-	-	-	067065
V3760-H7	Winkelschraubendreher H7		-	-	-	-	-	067072
V3760-A1	Adapterplatte A1		-	40	5,5	4	-	067089
V3760-B1	Adapterplatte B1		-	45	6	5	-	067096
V3760-F1	Adapterplatte F1		-	44	4	3,5	-	067102
V3760-P1	Adapterplatte P1		-	37	6	3,5	-	067119
V3760-G1	Druckplatte G1		-	42	5	5	-	067133
V6632	Steckschlüsseleinsatz			-	-	-	9 mm	066327
V6633	Steckschlüsseleinsatz			-	-	-	22 mm	066334
V6634	Steckschlüsseleinsatz			-	-	-	20 mm	066341
V6635	Steckschlüsseleinsatz			-	-	-	11,5 mm	066358

V3760-VW, EAN 4047728071666
Adapter VW

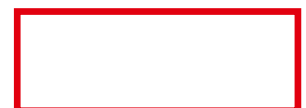

V1711N, EAN 4047728060738

Bremskolben-Rückstellwerkzeug Satz · pneumatisch

- Drehen und Drücken von Bremskolben an fast allen Pkw
- Effizientes, beschädigungsfreies Arbeiten an Bremsanlagen
- Für rechts- sowie linksdrehende Bremskolben
- Ermöglicht kontrolliertes Zurückdrehen per Hand zusätzlich zur pneumatischen Unterstützung
- Schnellverbinder ermöglicht einfaches Aufsetzen der Adapter
- Automatischer Ausgleich bei unterschiedlichen Gewindesteigungen
- 23-teiliger Satz: 1 Druckluftspindel · 22 Adapterplatten



Jetzt noch größere Marktabdeckung



V1711-1, EAN 4047728067331

Bremskolben-Rückstellwerkzeug · pneumatisch

- Für Rechts- und Linksgewinde
- Schützt vor Beschädigungen der Dichtungsmanschetten
- Ermöglicht zeitgleiches Betätigen und Drehen
- Magnet an der Aufnahme sorgt für sicheren Halt des Adapters



V7132N, EAN 4047728076500

Bremskolben-Rückstellwerkzeug Satz · hydraulisch

- Für Mehrkolben Bremsanlagen
Gleichmäßiges Rücksetzen des Bremskolbens,
ohne Beschädigung an Kolben und Dichtung
- Auswechselbare Pressbacken für
Spannbereich 30 – 70 mm
- Pressbacken 360° einstellbar
– optimale Anpassung
- Ideal für Schwimmsättel und Festsättel
- Einstellbar auf unterschiedlichste
Bremsattel-Formen und Kolbenzahl
- Pressplatten: 2x L 90x8 2 mm · 2x L
90x8 4 mm · 2x L 150x8 4 mm
- Maximale Kraftübertragung: 2 t



NEU



V7158, EAN 4047728**071581**

Bremssattel-Verschraubungs Satz

- Bremssattel-Verschraubungen an z.B. VW · AUDI · PORSCHE · MERCEDES-BENZ · BMW · FORD · MAZDA · Volvo
- Inklusive aller üblichen Profilgrößen zur Demontage / Montage des Bremssattels
- Sonderprofile zum Lösen der Verschraubungen von geteilten Bremssätteln
- Ideal für Schwimm- und Festbremssättel



VIGOR No.	Bezeichnung	Ausführung	■		SW	L mm	EAN 4047728+
V6633	Steckschlüsseinsatz		12 ²⁹ 1/2	-	22 mm	-	066334
V6634	Steckschlüsseinsatz		12 ²⁹ 1/2	-	20 mm	-	066341
V6635	Steckschlüsseinsatz		12 ²⁹ 1/2	-	11.5 mm	-	066358
V6636	Steckschlüsseinsatz		12 ²⁹ 1/2	-	14 mm	-	071406
V7158-1	Steckschlüsseinsatz		10 3/8	●	7 mm	24	071598
V7158-2	Steckschlüsseinsatz		10 3/8	●	8 mm	24	071604
V7158-3	Steckschlüsseinsatz		6.3 1/4	●	9 mm	20	071611
V7158-4	Steckschlüsseinsatz		10 3/8	○	9 mm	50	071628
V7158-5	Steckschlüsseinsatz		10 3/8	○	7 mm	65	071635
V7158-6	Steckschlüsseinsatz		10 3/8	○	7 mm	92	071642
V7158-7	Steckschlüsseinsatz		10 3/8	○	11 mm	100	071659
V7158-8	Steckschlüsseinsatz		10 3/8	○	8 mm	-	071888

V6632, EAN 4047728**066327**

Steckschlüsseinsatz

- Bremssattel-Verschraubungen an z.B. VW · AUDI · PORSCHE · MERCEDES-BENZ · BMW · FORD · MAZDA · Volvo



15 mm

V4930, EAN 4047728**049306**

Bremsscheiben Messschieber

- Schnelle, effektive Bestimmung des Bremsscheiben-Durchmessers ohne vorherige Demontage des Rades
- Zeitersparnis durch eindeutige Identifikation der verbauten Bremsanlage (Vorteil: weniger Fehlbestellungen)
- Spannungsbereich universell: 200 – 400 mm

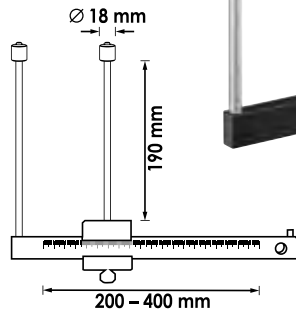

Durchführung der Messung ohne Rad-Demontage



V4399, EAN 4047728**043991**

Bremsscheiben Dickenmesser

- Schneller, effizienter Test zur Bestimmung der aktuellen Bremsscheiben-Dicke
- Hinweis: Mindestverschleißgrenzen der Bremsscheiben entnehmen Sie dem Fahrzeughersteller-Handbuch

Anzeigebereich 0 – 45 mm

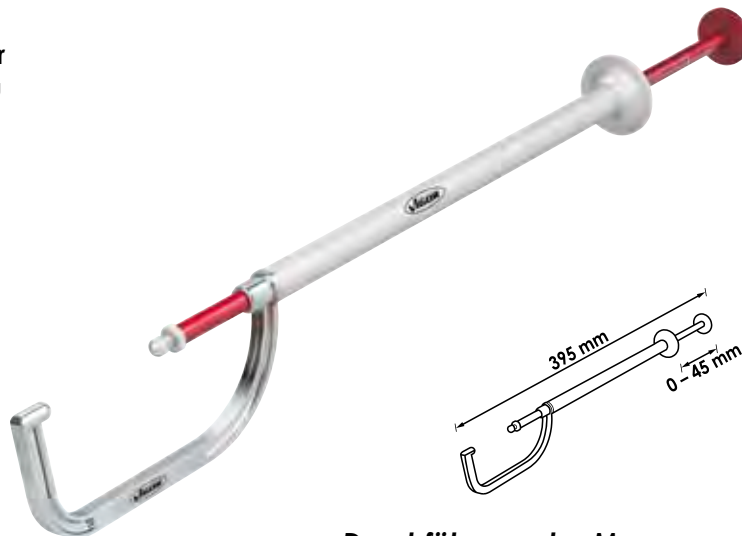

Durchführung der Messung ohne Rad-Demontage



V7401, EAN 4047728**074018**

Bremsscheiben-Dickenmesser · digital

- Messen der Mindest-Stärke von Bremsscheiben
- Durchführung der Messung ohne Rad-Demontage
- Digitale Anzeige LCD Display
- Edelstahlausführung
- Hinweis: Mindestverschleißgrenzen der Bremsscheiben im Fahrzeughersteller-Handbuch beachten
- Inklusive 3 Volt Batterie CR2032
- Messbereich von 0 – 80 mm



V4416, EAN 4047728044165

Bördelgerät für Ø 4,75 mm

- Ausschließlich für DIN Bördelungen
- Leicht und handlich
- Genaue Positionierung der Bremsleitung im Gerät erfolgt mittels Abstandsadapter
- Einsatz an Brems- bzw. Hydraulikleitungen direkt am Fahrzeug
- Für dünnwandige Stahl-, Aluminium- und Kupferleitungen (Metrisch / Zoll)
- Keine Beschädigung beschichteter Leitungen
- Für DIN F-Bördel 180°



Für DIN
F-Bördel



Besonders geeignet für den
Einsatz direkt am Fahrzeug

VIGOR No.	Bezeichnung	Ausführung	EAN 4047728+
V4416-1	DIN Bördelschraube 4,75 mm		049313
V4416-2	Gewindehülse		049337
V4416-3	Abstandsschraube		049344
V4416-4	Schraube		049351
V4416-5	Griff		049375

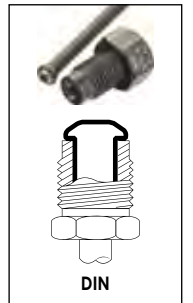

V4697, EAN 4047728046978

Bördelgerät für Ø 4,75 mm

- Bördelungen von Ø 4,75 mm Leitungen nach DIN und SAE Standard
- Extrem kleine Konstruktion gewährleistet Arbeiten auch bei engen Platzverhältnissen
- Keine Beschädigung beschichteter Leitungen
- Abstands Adapter verhindert Fehlpositionierung der Bremsleitung
- Für Stahl-, Aluminium- und Kupferleitungen
- Für DIN F-Bördel 180°, sowie SAE F Doppel-Bördel
- Inhalt:
 - 1 Grundgerät
 - 1 DIN-Bördeladapter
 - 1 SAE-Bördeladapter
 - 1 Abstands Adapter
 - 1 Spezialfett



Für DIN · SAE
und F-Bördel



Durch einfache und handliche
Bedienung besonders geeignet für
den direkten Einsatz am Fahrzeug

VIGOR No.	Bezeichnung	Ausführung	EAN 4047728+
V4416-1	DIN Bördelschraube 4,75 mm		049313
V4416-2	Gewindehülse		049337
V4416-3	Abstandsschraube		049344
V4416-4	Schraube		049351
V4697-1	Bördelschraube (SAE) · 4,75 mm		049320
V4697-2	Griff		049368

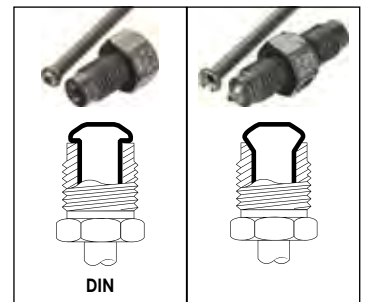

V1728, EAN 4047728017282

Bördelgerät Satz

- Direkter Einsatz an Brems- bzw. Hydraulikleitungen am Fahrzeug
- Für dünnwandige Stahl-, Aluminium- und Kupferleitungen (Metrisch / Zoll)
- Anfertigung von Konvex und Doppelbördelungen (DIN/SAE-Standards)
- Keine Beschädigung beschichteter Leitungen
- Für DIN F-Bördel 180°, sowie SAE F Doppel-Bördel, ebenso wie den einfachen D Bördel



Für DIN · SAE Bördel



VIGOR No.	Bezeichnung	Ausführung	EAN 4047728+
V2466	Schnellwechsel-Halterung		024662
V2559	Grundgerät		025591
V2467	Hydraulik-Spindel		024679
V2558	Druckstück 90° DIN / SAE		025584
V2553	Druckstück DIN/SAE		025539
V2554	Druckstück DIN/SAE		025546
V2556	Druckstück DIN/SAE		025560
V2555	Druckstück DIN/SAE		025553
V2626	Rohrschneider		026260
V2551	Spannbacken-Paar		025515
V2552	Spannbacken-Paar		025522
V2540	Spannbacken-Paar		025409
V1782	Rohrbieger		017824



V5513, EAN 4047728055130

Bördelgerät Satz

- Bördeln von Stahl-, Aluminium-, oder Kupfer-Bremsleitungen mit $\varnothing 4,75 \cdot 5 \cdot 5,15 \cdot 5,25 \cdot 6$ mm
- Moderne BMW- und VAG-Bremsleitungen sind mit zusätzlicher Kunststoffschicht überzogen ($\varnothing 5,15$ bzw. $5,25$ mm)
- Bördeln ist mit handelsüblichen Bördelgeräten nicht möglich
- Ausschließlich für DIN Bördelungen
- Direkter Einsatz an Brems- bzw. Hydraulikleitungen am Fahrzeug

Für neuartige VAG und BMW Bremsleitungen mit zusätzlicher Ummantelung

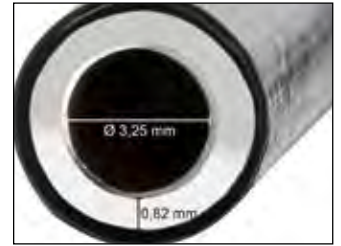

Neuartige Bremsleitung



Positionierung der Leitung um Ummantelung abzuschaben



Aufstecken der Überwurfmutter



Positionieren der Leitung



DIN-Bördelvorgang



VIGOR No.	Bezeichnung	Ausführung	EAN 4047728+
V5513-1	DIN Bördelschraube 6 mm		055147
V5513-2	Leitungsschneider 3 – 16 mm		055154
V5513-3	Leitungsschaber 3 – 16 mm		055161
V4416-1	DIN Bördelschraube 4,75 mm		049313
V4416-2	Gewindehülse		049337
V4416-3	Abstandsschraube		049344
V4416-4	Schraube		049351
V4697-2	Griff		049368
V1782	Rohrbieger		017824



V5649, EAN 4047728056496

Entgrater für Bremsleitungen · innen / außen

- Entgraten von Bremsleitungen
- Für Rohr-Innen-Ø 3 – 12 mm
- Für Rohr-Außen-Ø 4 – 14 mm
- Entgraten von Bremsleitungen
- Für Stahl, Kupfer, Edelstahl, Aluminium Leitungen

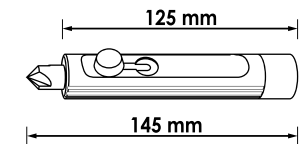

V2789N, EAN 4047728062824

Inspektions-Werkzeug für Brems- und Kraftstoffleitungen

- Aufspüren verborgener Korrosionsstellen bei Hauptuntersuchung
- 12 Abstreichflächen zur Beseitigung von Schmutz und Korrosion verschiedener Leitungen
- Ø 3,5 mm · 4,0 mm · 4,75 mm

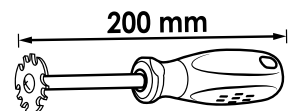

V5691, EAN 4047728056915

Bremssattelfeile

- Entfernen von Bremsstaub, Rost und Verschmutzungen am Bremssattel ohne Beschädigung der Bremsmanschetten
- Extrem schmale Bauform ermöglicht hohe Flexibilität
- Alle vier Seiten des Vierkants mit 2 unterschiedlichen Stärken (Hieb) verzahnt
- Breite Vierkant: 9 mm

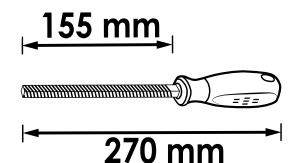

V5909, EAN 4047728**059091**

Bremshaken

- Aufhängen des Bremssattels bei Bremsarbeiten (Beschädigung des Bremsschlauchs wird verhindert)
- Auch zum Aufhängen von Schläuchen oder Kabeln
- Oberfläche: tauchisoliert



V2250, EAN 4047728**022507**

Bremssattel-Bürste · Stahl

- Entfernen von hartnäckigem Bremsstaub
- Sehr schmale Ausführung



Mit Aufhängeloch

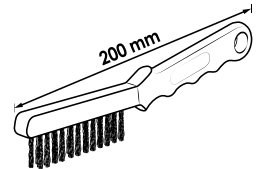

V2249, EAN 4047728**022491**

Bremssattel-Bürste · Messing

- Reinigen von Aluminium-Bremssätteln
- Entfernen von hartnäckigem Bremsstaub
- Für enge Bremssattelschächte



Mit Aufhängeloch

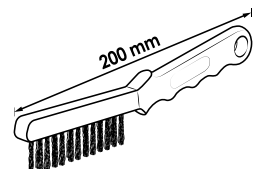

V6917, EAN 4047728069175

Bremsleitungs Ratschen-Rohrschneider

- Platzsparend, mit Ratschen-Mechanismus
Für 4,75 mm Bremsleitungen
- Ratschen-Mechanismus im Kopf des Werkzeuges
minimiert Platzbedarf – direkt am Fahrzeug verwendbar
- Kein Nachstellen des Schneidrades durch Selbstjustierung
- Schnelleres Schneidergebnis als
konventionelle Leitungsschneider
- Einstellen der selbstjustierenden Schneidkraft möglich
- Ersatzklingen V6917-REP



Selbstjustierend



V6917-REP, EAN 4047728069199

Ersatzschneidrad für Bremsleitungs Ratschen- Rohrschneider V6917



V1782, EAN 4047728017824

Rohrbieger

- Für Kupfer-, Messing-, Alu- und Weichstahlrohre
- Biegen bis zu 90°
- Biegen von Rohren mit 3 mm, 4,75 mm und 6 mm Ø



V7244, EAN 4047728072441

Bremsleitung-Begradigungswerkzeug
 \varnothing 4,75 mm

- Einfaches Begradigen von 4,75 mm Leitungen
- Speziell für Bremsleitungen aus Stahl oder Kupfer-Nickel
- Effektive Methode, um unförmige Leitungen zu begradigen, speziell für Rollenware
- Einfaches Hin- und Herschieben ist als Anwendungsimpuls ausreichend
- Zielgerichtetes Begradigen verringert den Materialaufwand
- Ersetzt konventionelles, unpräzises Formen von Leitungen



V7259, EAN 4047728072595

Bremsleitung-Biegewerkzeug \varnothing 4,75 mm

- Biegevorrichtung zum einfachen Duplizieren von formtreuen Bremsleitungen



V7120, EAN 4047728077200

Bremseleitung-Haltewerkzeug

- Beschädigungsfreies Halten von $\varnothing 4,75$ mm Bremsleitungen durch optimierte Klemmung
- Die Bremsleitung kann im eingebauten Zustand nachgebogen werden, um eine exakte Form des Originals nachzubilden
- Für Stahl, Kupfer-Nickel sowie kunststoffummantelte Bremsleitungen



NEU

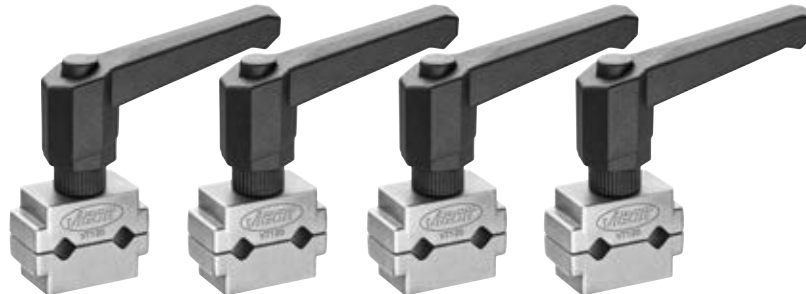

Räder / Reifen

Schlagschrauber-Krafteinsätze

293-295

Wagenheber und Böcke

296-299

Räder / Reifen-Werkzeuge

299-303

V6311, EAN 4047728**077798**

Schlagschrauber Steckschlüsseinsatz · TESLA

- 22,2 mm Sechskant beziehungsweise 7/8"
- 21 mm Radmuttern können sich, aufgrund von Witterungsbedingungen, plastisch verformen und ausdehnen



NEU

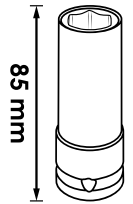

V4309, EAN 4047728**043090**

Schlagschrauber Steckschlüsseinsatz · MERCEDES-BENZ

- Betätigung von Radschrauben mit MERCEDES-BENZ Spezialprofil
- Für folgende Modelle:
 - C-Klasse · GLK (W204)
 - E-Klasse (W211 · W212 · W207)
 - SLK (W172)
 - M-Klasse (W164 · W166)
 - CL-Klasse (W216)
 - S-Klasse (W221, W222)
 - MAYBACH
- Für Maschinenbetätigung

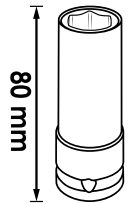

V6309, EAN 4047728**075534**

Schlagschrauber Steckschlüssel Satz

- Betätigung von beschädigten 19 mm FORD Radmuttern
- Für z.B.: FORD B-Max · C-Max · Fiesta · Focus · Mondeo · Transit
- Inhalt:
 - 18,5 mm Schlagschrauber Steckschlüsseinsatz für Radmuttern mit fehlender Chromkappe
 - 19,5 mm Schlagschrauber Steckschlüsseinsatz für Radmuttern mit verformter Chromkappe

Die 19 mm FORD Radmuttern können sich aufgrund von Witterungsverhältnissen verformen und ausdehnen. Dadurch ist der Einsatz eines herkömmlichen 19 mm Steckschlüssel-Einsatzes nicht mehr möglich. Ebenso kommt es oft zum Verlust oder zur Beschädigung der verchromten Schutzkappe dieser Radmuttern. Unsere Lösung: Zwischengrößen mit 18,5 mm und 19,5 mm Innensechskant Profilen.

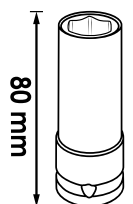
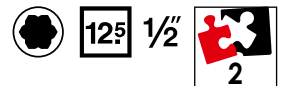

V5930, EAN 4047728059305

Schlagschrauber Steckschlüsseinsatz · lang

- Beschädigungsfreie Betätigung von Radschrauben durch mitdrehenden Kunststoffschutz
- Für Maschinenbetätigung

12⁵ 1/2

SW 17 mm

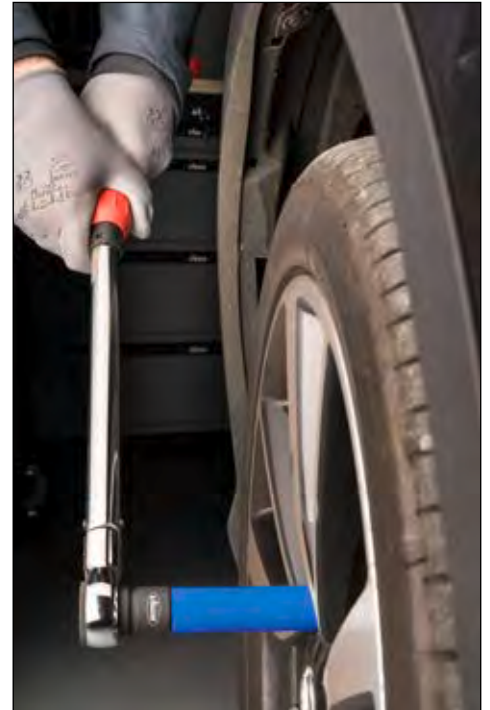

Vergleich Standard-Steckschlüsseinsatz zu extra langem Steckschlüsseinsatz

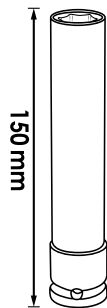

V5931, EAN 4047728060318

Schlagschrauber Steckschlüsseinsatz · lang

- Beschädigungsfreie Betätigung von Radschrauben durch mitdrehenden Kunststoffschutz
- Für Maschinenbetätigung

12⁵ 1/2

SW 19 mm



Vergleich Standard-Steckschlüsseinsatz zu extra langem Steckschlüsseinsatz

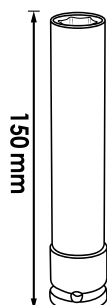

Schlagschrauber-Krafteinsätze



V6312/10, EAN 4047728077804

Schlagschrauber Steckschlüsseleinsatz Satz

- Beschädigungsfreie Betätigung von Radschrauben durch mitdrehenden Kunststoffschutz
- Satz mit allen benötigten Steckschlüsseleinsätzen
- Für Maschinenbetätigung

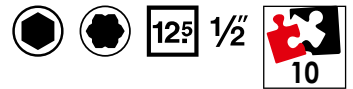

NEU



V2522, EAN 4047728025225

Schlagschrauber Steckschlüsseleinsatz Satz

- Für Maschinenbetätigung

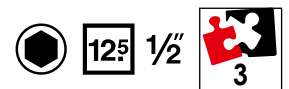

VIGOR No.	mm	SW	EAN 4047728+
V2472	85	17 mm	024723
V2473	85	19 mm	024730
V2474	85	21 mm	024747

V2257, EAN 4047728022576

Schlagschrauber Steckschlüsseleinsatz Satz

- Für Maschinenbetätigung

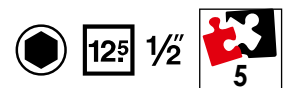

VIGOR No.	mm	SW	EAN 4047728+
V2471	85	15 mm	024716
V2472	85	17 mm	024723
V2473	85	19 mm	024730
V2474	85	21 mm	024747
V2475	85	22 mm	024754



V2481, EAN 4047728024815

Hydraulik Alu Rangier-Wagenheber 1,35 Tonnen

- Radwechsel am Fahrzeug bzw. Reparaturen unter dem Fahrzeug, bei denen eine Hebebühne nicht notwendig ist
- \approx 10 kg

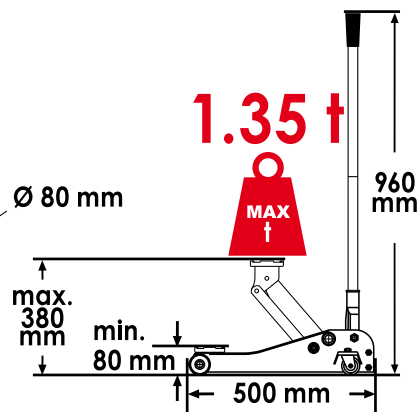
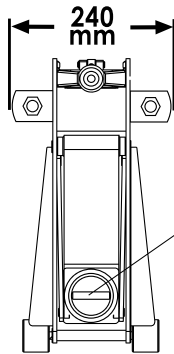

Alu-nur 10 kg



VIGOR No.	Bezeichnung	EAN 4047728+
V2631	Bockrolle (Paar)	026314
V2632	Lenkrolle (Paar)	026321
V2639	Hydraulik-Einheit	026390
V2640	Gummi-Auflage	026406

V6028, EAN 4047728060288

Hydraulik Rangier-Wagenheber 2 Tonnen · ultraflach

- Radwechsel am Fahrzeug bzw. Reparaturen unter dem Fahrzeug, bei denen eine Hebebühne nicht notwendig ist
- Robuste Gummiauflage für sicheren Halt
- Schneller Hub dank Turbo-Lift-Funktion
- Solider Stahlkorpus – garantiert hohe Qualität
- Geräuscharme Rollen aus Polyurethan
- \approx 32 kg

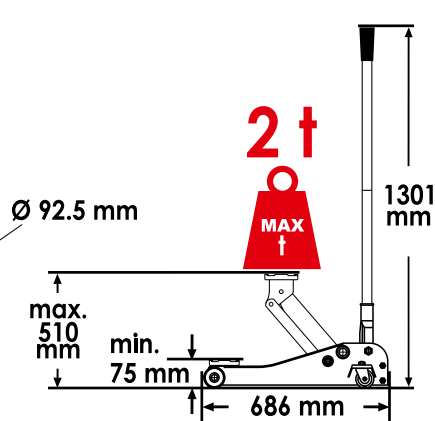
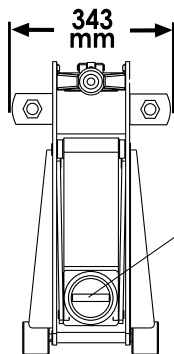

VIGOR No.	Bezeichnung	EAN 4047728+
V6028-1	Bockrolle (Paar)	062503
V6028-2	Lenkrolle (Paar)	062497
V6028-3	Gummi-Auflage	062480
V6028-4	Hydraulik-Einheit für V6028	062473

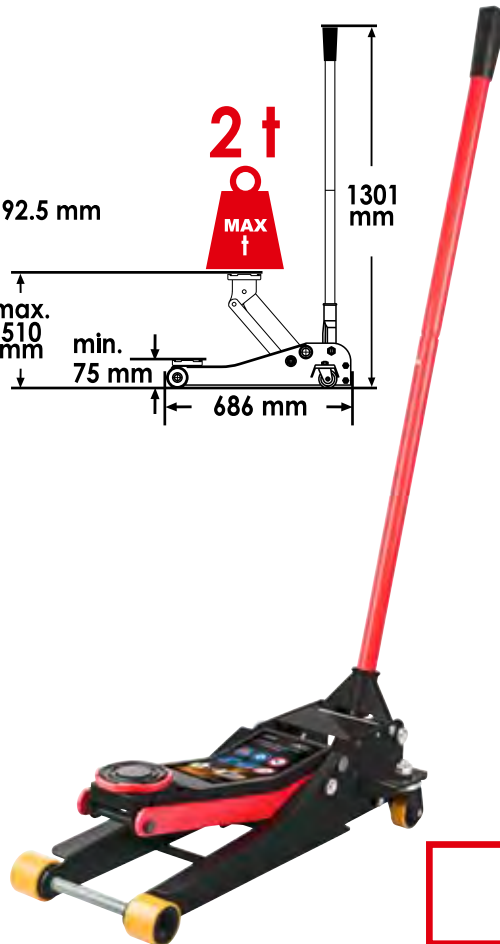

V6031, EAN 4047728071109

Hydraulik Rangier- Wagenheber 2 Tonnen · extra lang

- Radwechsel am Fahrzeug bzw. Reparaturen unter dem Fahrzeug, bei denen eine Hebebühne nicht notwendig ist
- \pm 42 kg

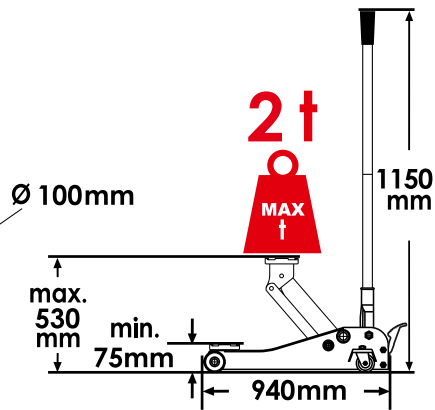
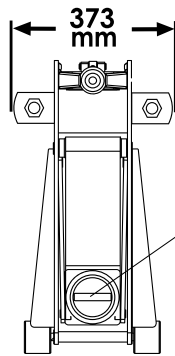

VIGOR No.	Bezeichnung	EAN 4047728+
V6031-1	Bockrolle (Paar)	075879
V6031-2	Lenkrolle (Paar)	075886
V6031-3	Gummi-Auflage	075893

V6029, EAN 4047728069786

Hydraulik Rangier- Wagenheber 3 Tonnen

- Radwechsel am Fahrzeug bzw. Reparaturen unter dem Fahrzeug, bei denen eine Hebebühne nicht notwendig ist
- \pm 31 kg
- Kompakte Bauform
- Geräuscharme Rollen aus Polyurethan

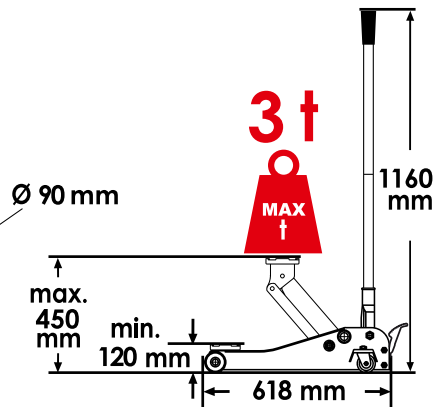
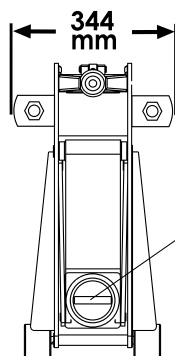

Fußpedal ermöglicht rasches Ansetzen an der Wagenheber-Aufnahme



VIGOR No.	Bezeichnung	EAN 4047728+
V6029-1	Bockrolle (Paar)	075855
V6029-2	Lenkrolle (Paar)	075848
V6029-3	Gummi-Auflage	075862



V2478, EAN 4047728024785

Flaschen-Wagenheber 6 Tonnen

- Horizontaler und vertikaler Einsatz
- ⚖️ 4,4 kg

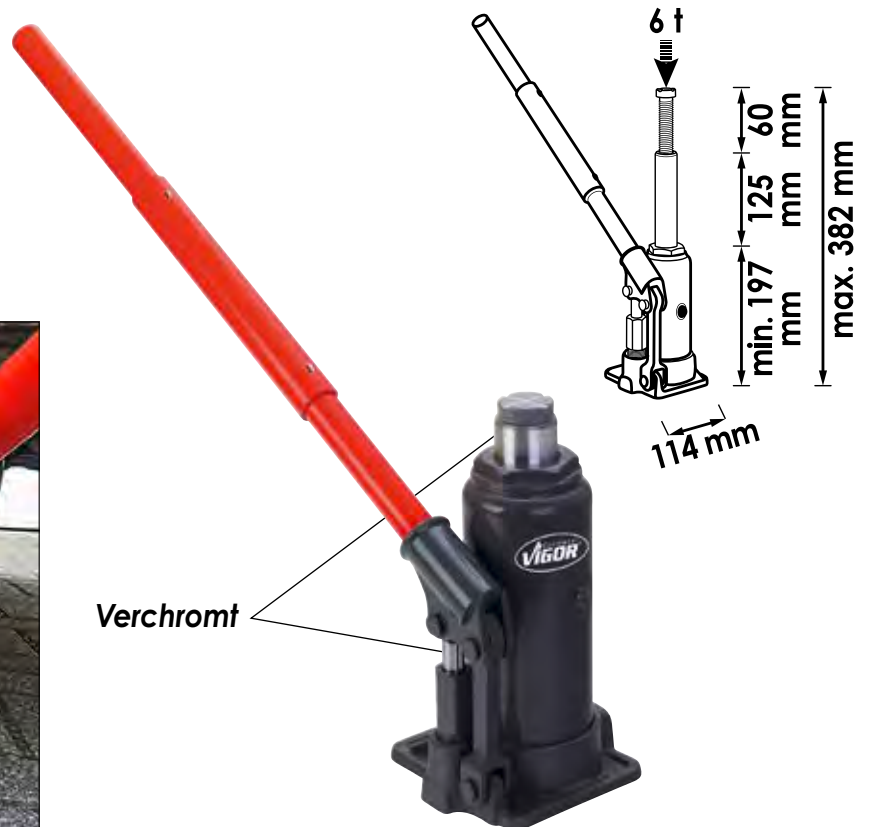

V2477, EAN 4047728024778

Unterstellbock Satz 3 Tonnen

- ⚖️ 5,2 kg pro Paar
- Tragkraft: 3 Tonnen
- Höhe 315 – 460 mm
- Tiefe: 230 mm

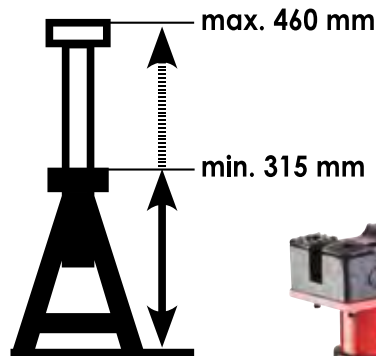

VIGOR No.	Bezeichnung	EAN
V2762	Gummi-Auflage	4047728+027625

Wagenheber und Böcke Räder / Reifen-Werkzeuge



V2648, EAN 4047728026482 Unterstellbock Satz 6 Tonnen

- 11 kg pro Paar
- Tragkraft: 6 Tonnen
- Höhe 370 – 575 mm
- Tiefe: 300 mm

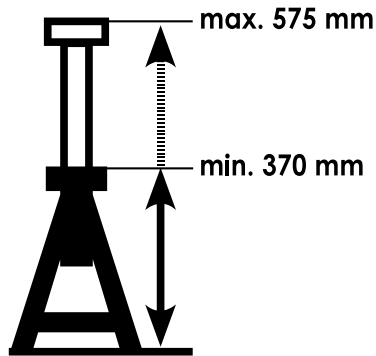

VIGOR No.	Bezeichnung	EAN 4047728+
V2762	Gummi-Auflage	027625



V3657, EAN 4047728074520 Klebegewicht-Zange

- Lösen und Befestigen von Auswuchtgewichten
- Backenöffnung optimal angepasst an Form der Klebegewichte
- Schneidfunktion von Meterwaren
- Spezielle Backenform ermöglicht Entfernung von Klebe- oder Schlaggewichten



V3563, EAN 4047728**035637**

Reifen- und Montagehebel mit Kunststoff-Belag

- Auf- und Abziehen der Reifen an Stahl- und insbesondere Alu-Felgen
- Länge: 500 mm



Verchromt

Mit verschraubtem, auswechselbarem Kunststoff-Belag, inklusive Schrauben



VIGOR No.	Bezeichnung	EAN 4047728+
V3615	Kunststoff-Belag mit Schrauben	036153

V2512, EAN 4047728**025126**

Klebegewicht-Entferner Satz

- Demontage Klebegewichten auf Alufelgen bei Pkw und Motorrad
- Lösemittelbeständig
- Mittels Feile nachschleifbar
- Auch zum Ablösen von Etiketten, Klebe- und Typenschildern
- Oberflächen werden nicht beschädigt

VIGOR No.	mm	mm	EAN 4047728+
V2513	19	500	025133
V2514	22	500	025140
V2515	25	500	025157
V2516	38	500	025164



V1657, EAN 4047728**016575**

Auswuchtgewicht-Zange

- Befestigen, Lösen und Abschneiden von Auswuchtgewichten

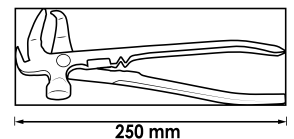

V1584, EAN 4047728**015844**

Profiltiefenmesser

- Messung von Profiltiefen, Bremsklötzen und Bremsbelägen
- Nullstellung in jeder Position
- 3 V (CR 2032)–240 mAh

Maximal 27 mm



Große LCD-Anzeige

Umschaltung mm / Inch möglich

V1423, EAN 4047728014236

Reifendrucktester

- Schnelle Überprüfung des Reifendrucks
- Klein und handlich
- Digitalanzeige
- Messbereiche:
 - 0,15 – 7 bar
 - 2 – 99,5 PSI
 - 15 – 70 KPA
- 3 V (CR 2032) – 240 mAh



**Automatische
Abschaltung
nach 90 Sek.**

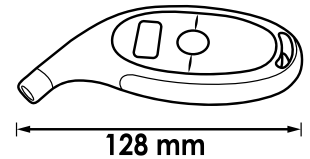

Gummihammer

- Lösen festgerosteter Felgen beim Radwechsel



Kunststoff-Stiel

**Rückschlagfrei
durch Stahlkugeln**

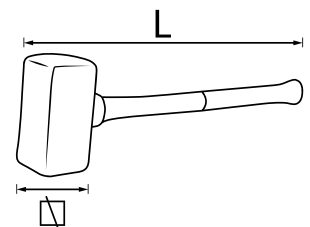

VIGOR No.	□ mm	l mm	Δ kg	EAN 4047728+
V2235	50	500	2.5	022354
V2234	74	900	5	022347

V1571, EAN 4047728015714

Lenkrad-Einstellwaage

- Ausrichtung des Lenkrades während der Achsvermessung sowie bei Arbeiten im Bereich der Lenksäule
- Schnelle Montage
- Einfache Justierung am Lenkrad
- Leicht ablesbar
- Universell einsetzbar für Pkw, Transporter und Lkw
- Durch Nutzung der Lenkrad-Einstellwaage können Lenkrad-Fehlstellungen vermieden werden
- Eine genaue Achsvermessung sollte stets durch geeichtes Achsvermessungsgerät durchgeführt werden

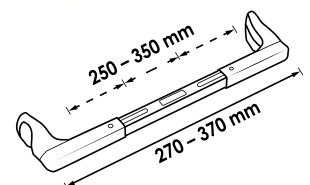

V7181, EAN 4047728071819

Gewindeschneid Satz für Radschrauben und Radmuttern

- Beschädigte oder rostige Gewinde können falsche Drehmomentwerte verursachen
- Nachschneiden und Reinigen von Radschrauben und Radmuttern mit Innen- und Außengewinde
- Direkt am Fahrzeug anwendbar
- TIN-HSS beschichtete Oberfläche
- Im Kunststoffkoffer
- Geeignet für folgende Gewindegrößen:
 - M 12x1,25 mm
 - M 12x1,5 mm
 - M 14x1,5 mm



Beschädigte oder rostige Gewinde können falsche Drehmomentwerte verursachen

Innengewinde



Außengewinde



VIGOR No.	Bezeichnung	Ausführung	EAN 4047728+
V7181-1	Schneideisen · M 12x1,25 TIN		071840
V7181-2	Schneideisen · M 12x1,5 TIN		071833
V7181-3	Schneideisen · M 14x1,5mm TIN		071826
V7181-4	Handgewindebohrer · M 12x1,25 TIN		071864
V7181-5	Handgewindebohrer · M 12x1,5 TIN		071857
V7181-6	Handgewindebohrer · M 14x1,5 TIN		071871



V7001, EAN 4047728**075060**

Universal Felgenschloss- Demontage Satz

- Formbare Felgenschlüssel zum Lösen von nahezu allen Felgenschlössern
- Unter anderem auch für Felgenschlösser mit Kleeblatt-Profil
- Formbare Felgenschlüssel passen sich durch Hammerschlag an das Profil an
- Beidseitig verwendbar
- Mehrfachverformung einer Schlüsselseite nicht möglich
- Inhalt:
 - 8 Felgenschlüssel
 - 2 Adapter
 - Steckschlüsseinsatz 12,5 mm (1/2") - SW 24 mm
 - Schlagkörper
 - Zentrierdorn
 - Handschutz-Polster



V7001/4, EAN 4047728**075336**

Felgenschlüssel Satz

- Zweiseitig verwendbare Felgenschlüssel mit \varnothing 13 mm und 15 mm
- Für Universal Felgenschloss Demontage Satz V7001
- Material: AHSS (Kohlenstoffstahl)

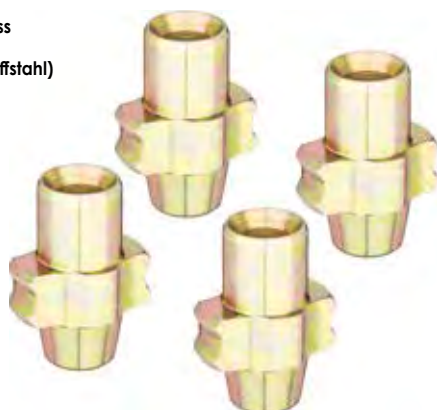





Karosserie

Scheibenwischerarm-Abzieher Satz

306

Reparatur und Einbausätze

307

Induktionsheizgerät und Zubehör

308–313



V2523, EAN 4047728025232

Scheibenwischerarm-Abzieher Satz

- Universell verwendbar
- Ermöglicht problemlosen Ausbau aller gängigen Wischerarme
- Optimale Einsatzmöglichkeiten bei gerosteten und festsitzenden Wischerarmen
- Größtmöglicher Schutz für integrierte Wischerdüsen bei Anwendung mit Schlagauszieher



VIGOR No.	Bezeichnung	Ausführung	EAN 4047728+
V4153	Abzieher · universal		041539
V4154	Schlagauszieher		041546
V4155	Druckspindel		041553
V4156	Spindelverlängerung		041560
V4157	Spindelvorsatz		041577
V4159	Zugglocke Nr. 1		041591
V4160	Zugglocke Nr. 2		041607
V4161	Zugglocke Nr. 3		041614
V4163	Zugglocke Nr. 5		041638
V4164	Zugglocke Nr. 6		041645
V4165	Zugglocke Nr. 7		041652
V4158	Zugglocke Nr. 8		041584



V3551N, EAN 4047728**075084**

Kunststoff-Reparatur Satz

- Reparatur und Verstärkung von Kunststoffteilen wie z.B. gerissene Lampenbügel und Gehäuseteile
- Umfangreich und praktisch für Haushalt, Werkstatt oder Handwerk
- 3-in-1 Funktion mit auswechselbaren Aufsätzen
- Klammern aus rostfreiem Edelstahl
- Im Lieferumfang enthalten:
 - 50 Reparaturklammern Typ W / Ø 0,6 mm
 - 50 Reparaturklammern Typ W / Ø 0,8 mm
 - Je 5 Schweißstäbe, Material PE, PS, ABS
 - 10 Schweißstäbe, Material PP
 - 2 Verstärkungsgitter
- Leistung: 50 Watt
- Maximale Nutzungsdauer: 35 Min
- Ladezeit: 3,5 Stunden

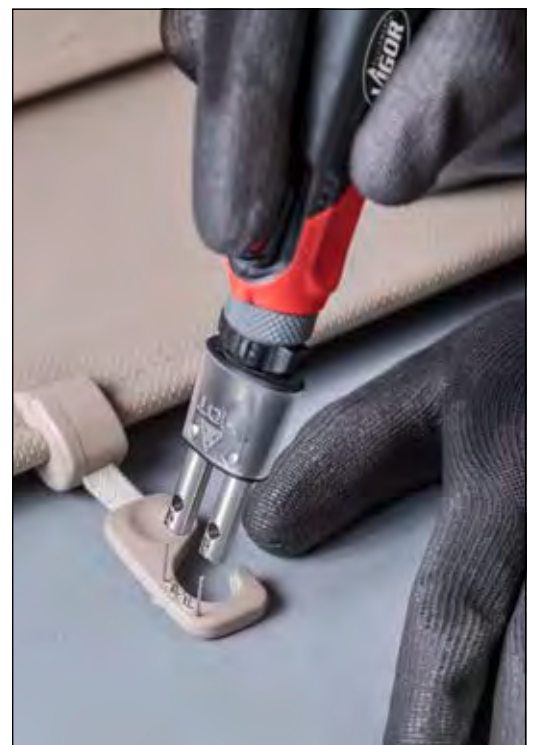

VIGOR No.	Bezeichnung	Ausführung	EAN 4047728+
V3670N	Ersatzklammern · 0,8 mm · V-Form		075671
V3671N	Ersatzklammern · 0,6 mm · V-Form		075688
V3672N	Ersatzklammern · 0,8 mm · W-Form		075695
V3673N	Ersatzklammern · 0,6 mm · W-Form		075701
V3676N	Ersatzklammern · 0,6 mm · U-Form		075718
V3677N	Ersatzklammern · 0,8 mm · U-Form		075725
V3551N-ABS	Kunststoff-Schweißstäbe Abs		077170
V3551N-PE	Kunststoff-Schweißstäbe Pe		077149
V3551N-PP	Kunststoff-Schweißstäbe Pp		077156
V3551N-PS	Kunststoff-Schweißstäbe Ps		077163
V3551N-W	Verstärkungsgitter		077132



V4891, EAN 4047728**048910**

Induktionsheizgerät

- Schnelles, einfaches Entfernen von Teilen an Fahrzeugen durch Erhitzung
- Durch umfangreiches serienmäßiges Zubehör vielseitig einsetzbar im Karosserie- und Nutzfahrzeugbereich
- Exakt platzierte Erwärmung innerhalb weniger Sekunden aufgrund modernster Mikroprozessor-Technologie
- Einfacher Transport durch Kunststoff-Koffer
- Vermeidung von Überhitzung bei gleichzeitig hohem Wirkungsgrad durch zwei Lüfter
- Anschlusskabel: 3 m
- Spulenschlauchlänge: 700 mm
- Gesteuerte Lüfterkühlung
- Starre Spulen: Erwärmung von Rohren, Bolzen, Profilen verschiedener Durchmesser
- Flexible Spule: zum Lösen von schwer zugänglichen Teilen durch den Einsatz von speziellem Wickeldraht
- Flachspule zur Erwärmung von Karosserie und Blech, vereinfacht das Abziehen von Aufklebern, Dichtstoffen etc.
- Robuste IGBT-Transistor-Technologie
- Kurzschluss- und Leerlaufest
- Automatische Anpassung an Resonanzfrequenz
- Frequenz: 25 kHz – 60 kHz
- 1,5 kW Leistung

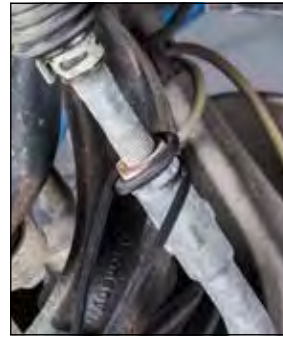
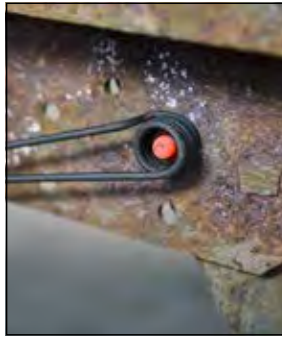

Exakt platzierte Erwärmung innerhalb weniger Sekunden aufgrund modernster Mikroprozessor-Technologie

Inklusive 4 Spulen



V4891-1, EAN 4047728**049573**

Starre Spule

- Gesamtlänge: 222 mm
- Vertikale Ausrichtung
- Innendurchmesser 19 mm, bis maximal M 8



V4891-2, EAN 4047728**049580**

Flexible Spule

- Gesamtlänge: 750 mm
- Flexible Anwendung an individuellen Kfz-Bauteilen
- Für schwer-erreichbare Stellen

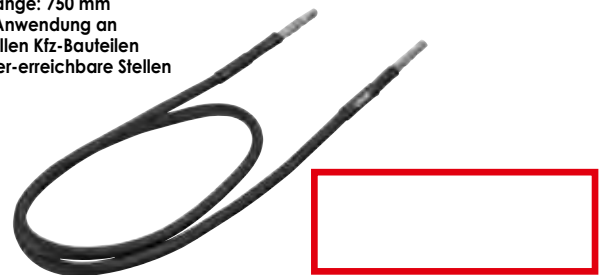

V4891-3, EAN 4047728**049597**

Starre Spule

- Gesamtlänge: 225 mm
- Vertikale Ausrichtung
- Innendurchmesser 26 mm, bis maximal M 12



V4891-4, EAN 4047728**049603**

Flach Spule

- Optimal für Flächenerwärmung
- Erwärmung flacher Schrauben
- Gesamtlänge: 227 mm
- Innendurchmesser 24 mm
- Außendurchmesser 45 mm

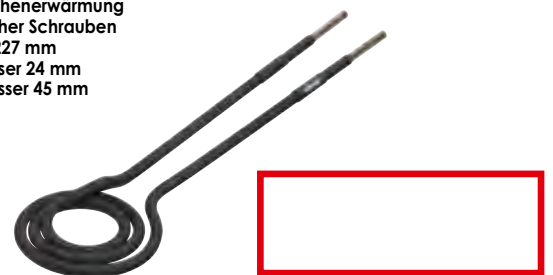

V4891/6, EAN 4047728062206

Induktionsspulen Erweiterungssatz

- Satz bestehend aus:
 - V4891-5 (Fokus-Spule für punktuelle Erwärmung)
 - V4891-6 (Starre Spule)
 - V4891-7 (Starre Spule)
 - V4891-8 (Flexible Spule, Keramikschutz)
 - V4891-9 (Starre Spule)
 - V4891-10 (Starre Spule, seitlich)



V4891-5, EAN 4047728062152

Fokus-Spule · für punktuelle Erwärmung

- Erwärmen von Bauteilen, bei denen das Erreichen mit Standard-Spulen nicht möglich wäre
- Spule für punktgenaues Erhitzen, zur Konzentrierung der Energie
- Während der Erwärmung sollte ein Abstand von circa 2 – 4 mm zum Werkstück eingehalten werden, um Beschädigungen der Spule zu vermeiden
- Gesamtlänge: 210 mm



V4891-6, EAN 4047728062169

Starre Spule

- Gesamtlänge: 220 mm
- Vertikale Ausrichtung
- Innendurchmesser 15 mm, bis maximal M 6

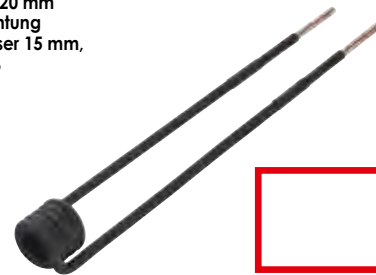

V4891-7, EAN 4047728062176

Starre Spule

- Gesamtlänge: 240 mm
- Horizontale Ausrichtung
- Innendurchmesser 45 mm, bis maximal M 22

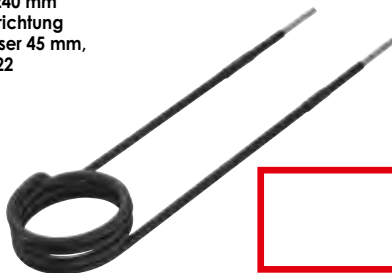

V4891-8, EAN 4047728062183

Flexible Spule · Keramikschutz

- Gesamtlänge: 800 mm
- Höhere Temperaturbeständigkeit
- Die Keramikbeschichtung verlängert die Lebensdauer
- Selbststellender Abstand bei kleineren Bauteilen



V4891-9, EAN 4047728062190

Starre Spule

- Gesamtlänge: 220 mm
- Vertikale Ausrichtung
- Innendurchmesser 45 mm, bis maximal M 22



V4891-10, EAN 4047728062343

Starre Spule · seitlich

- Gesamtlänge: 230 mm
- Horizontale Ausrichtung
- Innendurchmesser 23 mm, bis maximal M 10

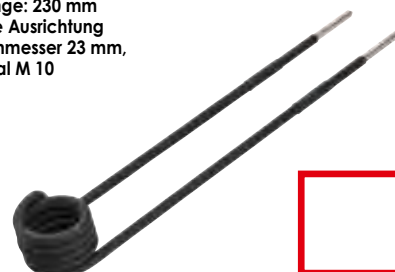

V4891-3.5, EAN 4047728072779

Induktionsheizgerät · Lkw 3,5 KW

- Starke 3,5 kW Variante für Kfz- sowie Nfz-Anwendungen
- Effiziente Methode der Erhitzung, ohne Beschädigung umliegender Bauteile
- Wassergekühlt
- Tragbar, trotz hoher Leistung
- Ausgabeleistung exakt auf den Anwendungsbereich einstellbar
- Möglichkeit der Kraftausgabe in 10 – 100 % Schritten
- Auslieferungszustand inklusive Kühlfüssigkeit
- Punktgenaue Erhitzung von Bauteilen und Elementen
- Betriebshinweis durch LED am Spulenkopf
- Zusätzlicher Ventilator im Gehäuse sorgt für Überhitzungsschutz der Hardwarekomponenten
- Exakt platzierte Erwärmung innerhalb weniger Sekunden aufgrund modernster Mikroprozessor-Technologie

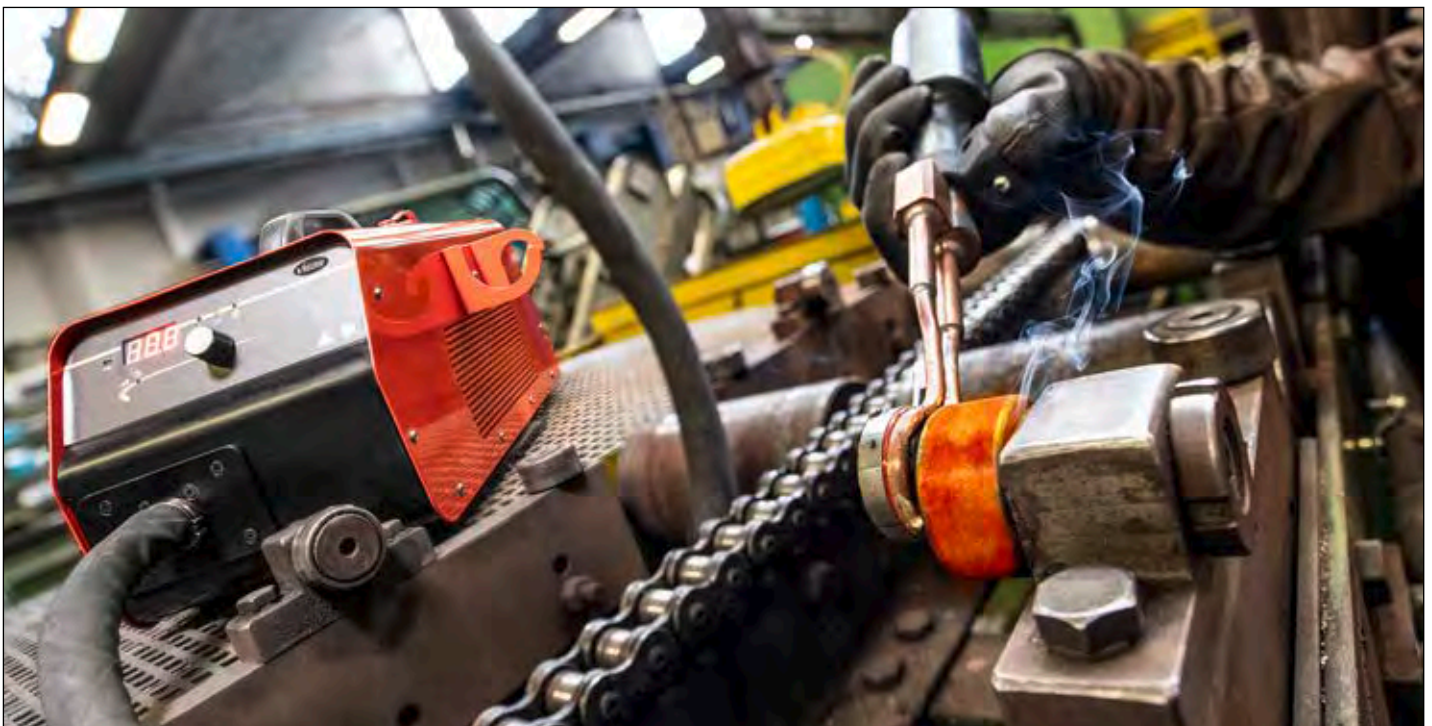

V4891-3.5-1, EAN 4047728072786

Erweiterungsspule · Radbolzen

- Extra schmale Bauform ermöglicht punktuell Erhitzen von Radbolzen



V4891-3.5-2, EAN 4047728072793

Standardspule · seitlich

Standardspule · seitlich



V4891-3.5-3, EAN 4047728072809

Reduzierstück

Reduzierstück zur Adaption der Einsteckspule V4891-3.5-4



V4891-3.5-4, EAN 4047728072816

Einsteckspule · 26 mm

Einsteckspule · 26 mm
Nur in Verbindung mit V4891-3.5-3



V4891-3.5-6, EAN 4047728072892

Rundspule · 32 mm

Rundspule · 32 mm



V4891-3.5-5, EAN 4047728072823

Kühlflüssigkeit · 3 l

Kühlflüssigkeit · 3 l



V4891-10.0, EAN 4047728077958

Induktionsheizgerät

- Ultrastarke 10 kW Variante zum Erhitzen von massiven Bauteilen
- Mobiles Gerät mit Fahrwerk und integrierter Wasserkühlung
- Leiser Betrieb
- Effiziente Methode der Erhitzung, ohne Beschädigung umliegender Bauteile
- Risikominimierung im Vergleich zu Acetylen Sauerstoff-Brennern
- 10 Liter, wassergekühlt
- Kompaktes Gerät im Verhältnis zur Ausgangsleistung von 10 kW
- Ausgabeleistung exakt auf den Anwendungsbereich einstellbar
- Stufenlose Leistungsregelung von 10 bis 100 Prozent
- Auslieferungszustand inklusive Kühlflüssigkeit
- LED am Spulenkopf zeigt Betrieb an
- Exakt platzierte Erwärmung innerhalb weniger Sekunden aufgrund modernster Mikroprozessor-Technologie
- Stromversorgung 3x400 V · 32A



NEU

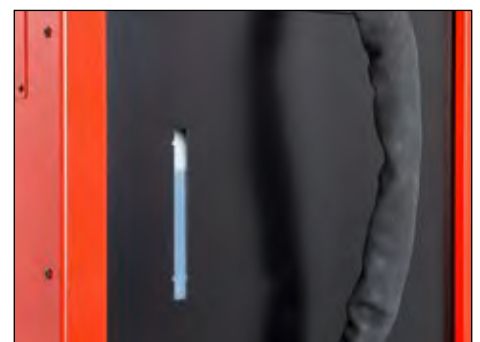

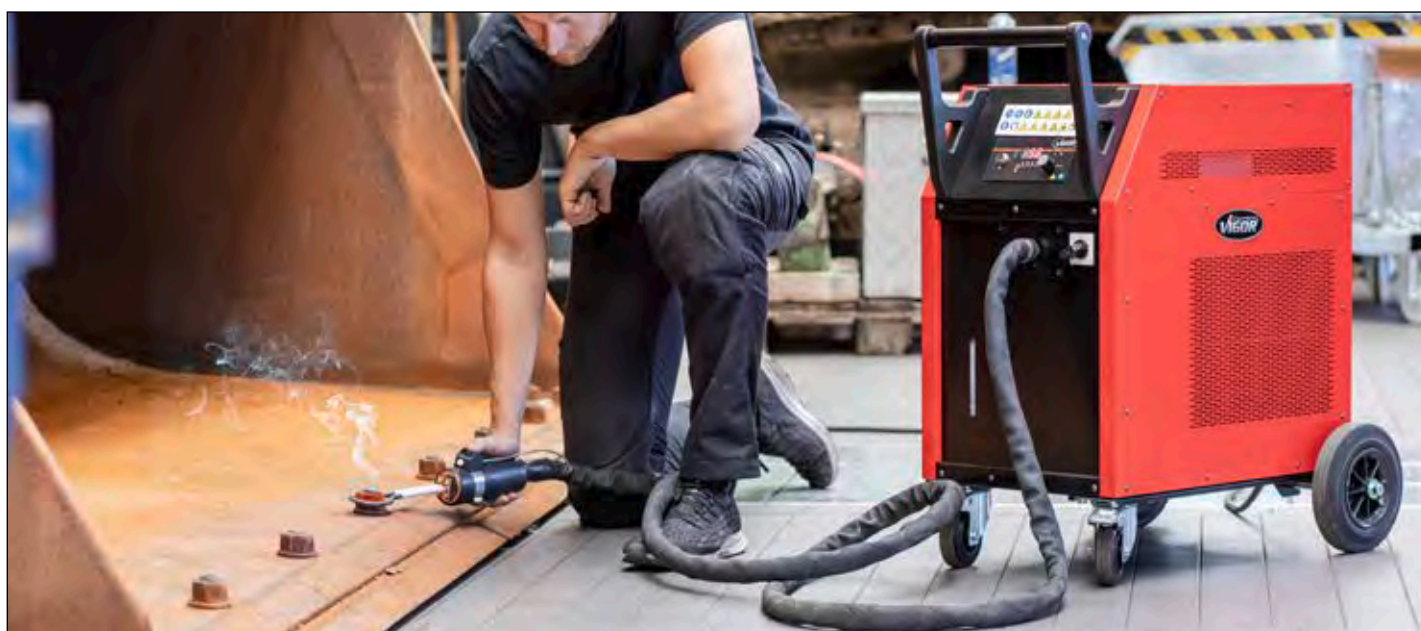
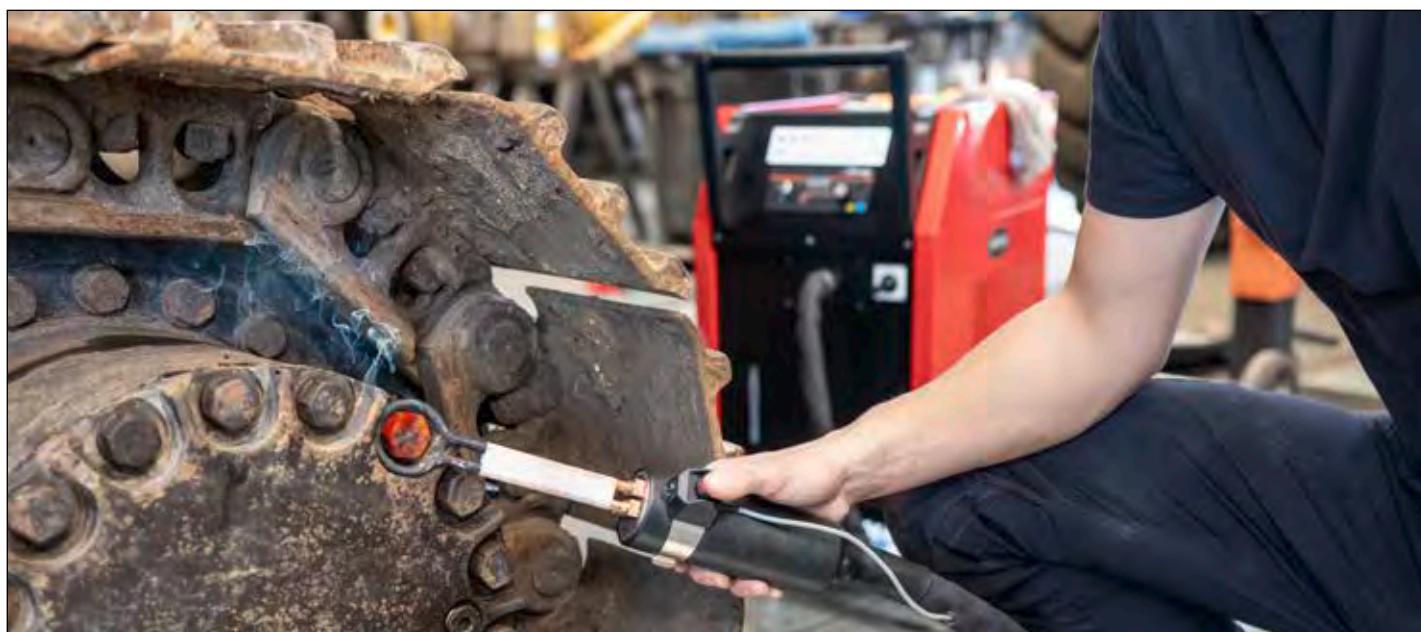

Spurstangengelenk Werkzeug

- Fachgerechter, schneller Austausch von Spurstangen-Axialgelenken an Pkw und leichten Nfz



Rollen aus Metall

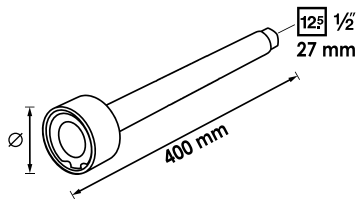

VIGOR No.	Bezeichnung	SW	mm	EAN 4047728+
V2683	Spurstangengelenk Werkzeug · 35 – 45 mm	27 mm	400	026833
V2684	Spurstangengelenk Werkzeug · 28 – 35 mm	27 mm	400	026840

V3863, EAN 4047728038638

Stoßdämpfer-Montagewerkzeug Satz

- Demontage / Montage an Stoßdämpfern mit Zuganschlagfeder
- Fixierung mittels Klemmstücken mit V-Form Kunststoffeinsätzen in Endanschlagposition ohne Beschädigung
- Für: BMW · FIAT · FORD · MERCEDES-BENZ · NISSAN · PEUGEOT · TOYOTA
- Inhalt:
 - Spezial-Grundkörper
 - Robuste M 12 Gewindespindel mit Spezialaufnahme
 - Universal Klemmstück mit V-Form-Kunststoffeinsätzen

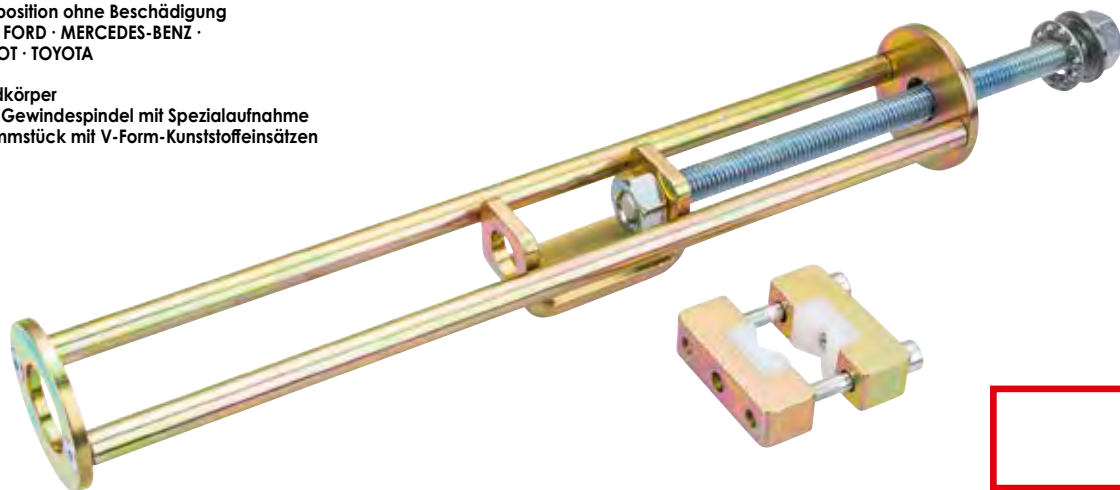

V3661, EAN 4047728036610

Klemmstück mit Kunststoff-Schonbacken (universal)



V4126N, EAN 4047728078566

Klemmschrauben Demontage- Werkzeug Satz

- Betätigen der Klemmschraube an der VAG Mehrlenker-Achse im eingebauten Zustand
- Kein Pressen oder Ziehen am Aluminium-Achsschenkel
- Bohrführungen garantiert exaktes Ausbohren der Stahlschraube
- Inhalt:
 - 3 Hochleistungsbohrer (HSS Cobalt) Größe: 6 · 8,5 · 10 mm
 - 1 Andrückbügel
 - 1 Durchtreiber
- Für zum Beispiel:
 - AUDI A4 Bj. 2015 → · A5 Bj. 2016 → · A6 Bj. 2018 → · A7 Bj. 2017 → · Q5 Bj. 2016 → · Q7 Bj. 2015 → · Q8 Bj. 2018 → · E-Tron Bj. 2018 →
 - VW Touareg Bj. 2017 →



NEU

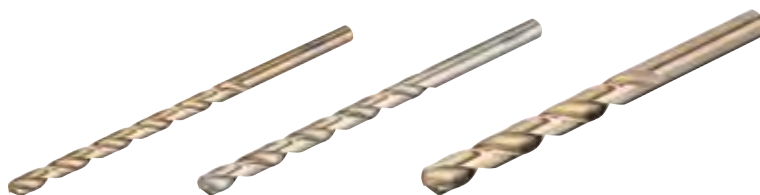

VIGOR No.	Ø	EAN 4047728+
V4248	6	042482
V4249	8.5	042499
V4250	10	042505



V6452, EAN 4047728**064521**

Stoßdämpfer-Werkzeug Satz

- Fachgerechte Instandsetzungsarbeiten am Federbein (Gegenhalten der Kolbenstange beim Aus- und Einbau)
- Betätigung Stoßdämpfer-Mutter am Domlager
- Für die gängigsten Fahrzeugtypen

- Inhalt:
 - Offene Umschaltknarre, SW 21 mm, Zwölfkant
 - Offene Sechskant-Einsätze:
 - 12,5 mm (1/2"), SW 16 · 17 · 18 · 19 · 21 · 22 · 24 mm
 - 12,5 mm (1/2") Schraubendreher Einsatz, SW 6 · 7 · 8 mm
 - 12,5 mm (1/2") Verlängerung: 250 mm
 - 12,5 mm (1/2") Steckschlüssel-Einsätze, oval 5 x 8 mm, 6 x 8 mm



VIGOR No.	Bezeichnung	Ausführung	EAN 4047728+
V6452-1	Umschaltknarre · offen		075220
V6452-5	Steckschlüsseinsatz Sonderprofil · MERCEDES-BENZ · 5 mm		075206
V6452-6	Steckschlüsseinsatz Sonderprofil · MERCEDES-BENZ · 6 mm		075213
V6452-16	Steckschlüsseinsatz · 16 mm		075091
V6452-17	Steckschlüsseinsatz · 17 mm		075107
V6452-18	Steckschlüsseinsatz · 18 mm		075114
V6452-19	Steckschlüsseinsatz · 19 mm		075121
V6452-21	Steckschlüsseinsatz · 21 mm		075138
V6452-22	Steckschlüsseinsatz · 22 mm		075145
V6452-24	Steckschlüsseinsatz · 24 mm		075152
V6452-250	Gleitgriff · 250 mm		075169
V6452-H6	Steckschlüsseinsatz Sechskant · 6 mm		075176
V6452-H7	Steckschlüsseinsatz Sechskant · 7 mm		075183
V6452-H8	Steckschlüsseinsatz Sechskant · 8 mm		075190



V6956, EAN 4047728**069564**

Universal Achshebel

- Fachgerechte, schonende Demontage und Montage von Achsteilen, wie z.B. Kugelgelenken und Querlenkern
- Kettenverstellung ermöglicht flexiblen Einsatz und Anpassung auf verschiedene Abmaße und Gegebenheiten
- Verwendete Spindel in hoher Güte gewährleistet kraftsparendes Arbeiten und hohe Kraftübertragung
- Direkte Verwendung am Fahrzeug ohne Hinzunahme einer zweiten Person
- Gummiisolierte Stützfläche gewährleistet sicheren Halt am Fahrzeug
- Ermöglicht die Betätigung mit Umschaltknarre oder Lufratsche

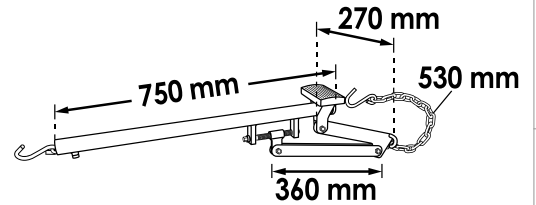

V4642, EAN 4047728**046428**

Gelenkwellen-Abzieher · universal

- Fachgerechte Demontage des Gleichlaufgelenkes sowie der Gummimanschetten der Antriebswelle
- Extrabreiter Rahmen, auch für große Gelenke

Speziell geformte Spannbacken garantieren sicheren Halt der Antriebswelle

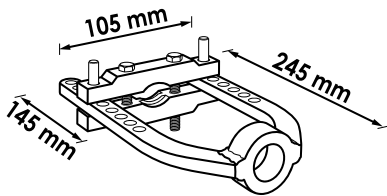

max. Ø 31.5 mm



V7525, EAN 4047728075251

Universal Pressunterlage

- Demontage und Montage von Lagern und Buchsen in Verbindung mit Werkstattpressen
- Optimierte Dreipunkt-Ausrichtung von Werkstücken an der Werkstattpresse
- Durch umfangreiche Verstellbarkeit sind nahezu alle Werkstücke parallel zur Werkstattpresse ausrichtbar, um die Sicherheit bei der Anwendung zu erhöhen
- Seitlicher Anschlag für sicheren Halt auf der Werkstattpresse
- Schwenkunterlage ermöglicht die schnelle und einfache Positionierung auf der Unterlage
- Maximal zugelassene Belastbarkeit: 20 Tonnen



V4636N, EAN 4047728078719

Lager-Innenring Abzieher

- Für Lager-Innenringe, die direkt an der Radnabe liegen
- Für Ringe im Spannungsbereich 33 – 60 mm
- Auswechselbare Kegel mit \varnothing 32 mm und \varnothing 40 mm für umfangreiche Marktabdeckung
- Auch geeignet für Modelle mit ABS-Küfig, z.B. VW Golf 4
- Feststellschraube verhindert Abrutschen der Arme
- Betätigung mit Umschaltknarre



NEU

Im Lieferumfang enthalten

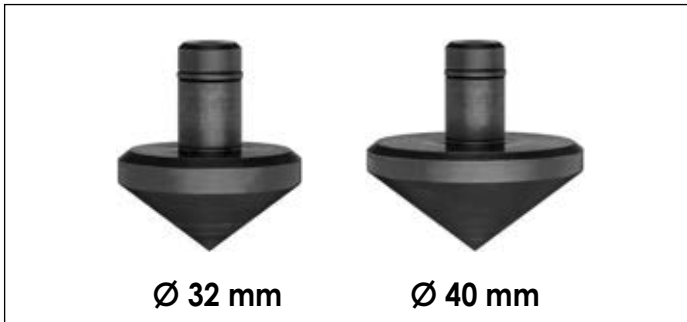

-
-
-
-
-
-
-
-
-
-
-
-

Kfz / Nfz Fahrwerk Spezial-Werkzeug

Druck- und Zugzylinder	322–324
Zubehör Zylinder	325–328
Mechanischer Antrieb	329–330 362–363
Hydraulik-Pumpen	331
Werkzeugsätze Standard-Radlager	332–334
Werkzeugsätze Kompakt-Radlager	335–336
Werkzeugsätze geschraubte Kompakt-Radlager	337–345
Werkzeugsätze Radnabe mit 6- und 8- Bolzen	344
Werkzeugsätze Antriebswellen	346
Multiboxen	347–361
Werkzeugsätze Lager und Buchsen	364–373
Federspanner	374–377
Mobile Werkbänke mit Spezialwerkzeug Sortiment	378–385
Spezial Weichschaum-Einlagen	386–393
Werkzeugsätze Nfz	394–415

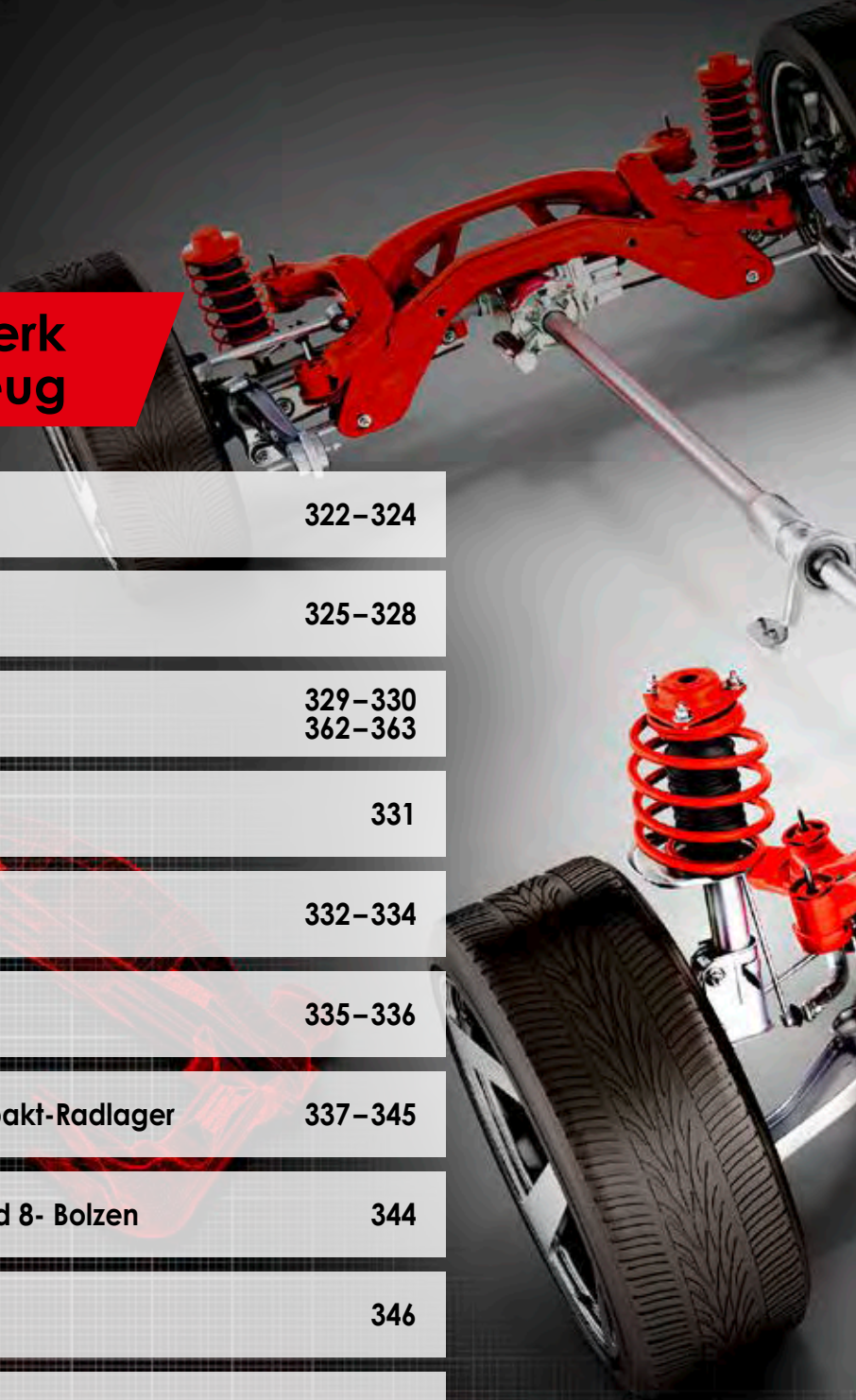



**DEIN
FAHRWERK
SPEZIALIST**

IN SACHEN WERKZEUG

V2873, EAN 4047728**028738**

Druck- und Zug-Hydraulikzylinder 8,5 Tonnen

- Auspressen von Traggelenken und Buchsen
- Einsetzbar auf engstem Raum
- Druckstange verstellbar

Automatischer Kolbenrücklauf



VIGOR No.	Bezeichnung	Ausführung	L mm	EAN 4047728+
V3012	CEJN-Nippel Hydraulik · 1/8 Zoll		-	030120
V3009	Hydraulik-Zylinder · 8,5 Tonnen		-	030090
V3011	Druckstange · verstellbar M 22		100	030113
V3010	Schlagkörper mit O-Ring		-	030106

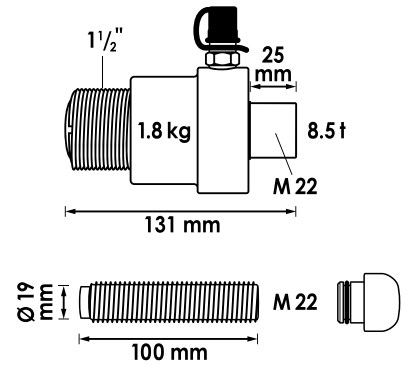

V2869, EAN 4047728**028691**

Druck-Hydraulikzylinder 14 Tonnen

- Auspressen von Traggelenken und Buchsen
- Speziell für Einsatz mit Pressbügel V2885 und V2858N

Automatischer Kolbenrücklauf

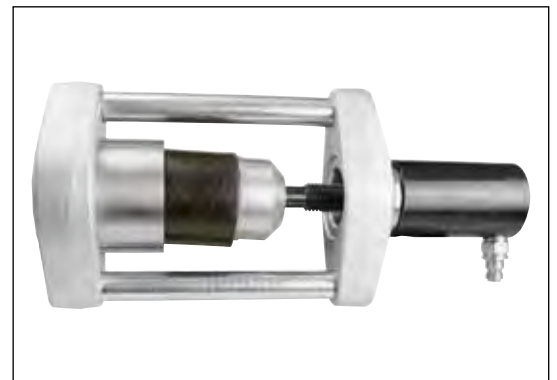

VIGOR No.	Bezeichnung	Ausführung	L mm	EAN 4047728+
V3128	(CEJN-) Nippel Hydraulik 1/4"		-	031288
V3217	Hydraulik-Zylinder · 14 Tonnen		-	032179
V3124	Druckstange · verstellbar M 24		92	031240

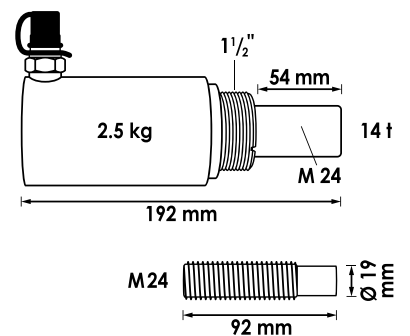

V4551, EAN 4047728045513

Druck- und Zug-Hydraulikzylinder 18 Tonnen

- Ausdrücken von festgerosteten Antriebswellen
- Druck des Hydraulikzylinders kann bei Verwendung eines Schlagkörpers mit Schlagkraft kombiniert werden
- Einsatz mit allen Pkw-Werkzeugen und Zugstangen M 10 – M 22 mit entsprechender Reduzierung

Automatischer Kolbenrücklauf



VIGOR No.	Bezeichnung	Ausführung	L mm	EAN 4047728+
V3128	(CEJN-) Nippel Hydraulik 1/4"		-	031288
V4552	Hydraulik-Zylinder · 18 Tonnen · ohne Zubehör		-	045520
V3125	Schutzring für Gewinde 1.1/2"		-	031257
V3127	Zugstange · M 18 M 22 · maximal 22 t		250	031271
V3123	Druckfuß M 24x3 mm		-	031233
V3124	Druckstange · verstellbar M 24		92	031240
V4553	Druckachse · M 24x3 mm		-	045537
V3126	Kragenmutter · M 18x2,5		-	031264
V3018	Schlagkörper · M 22x2,5 mm		-	030182
V3129	Druckstück · verstellbar M 24		132	031295

Extra leicht:
Nur 2,8 kg

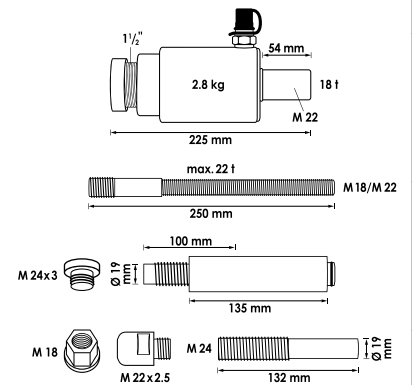

V2854, EAN 4047728028547

Druck- und Zug-Hydraulikzylinder 22 Tonnen

- Ausdrücken von festgerosteten Antriebswellen
- Druck des Hydraulikzylinders kann bei Verwendung eines Schlagkörpers mit Schlagkraft kombiniert werden
- Einsatz mit allen Pkw-Werkzeugen und Zugstangen M 10 – M 22 mit entsprechender Reduzierung

Automatischer Kolbenrücklauf



VIGOR No.	Bezeichnung	Ausführung	L mm	EAN 4047728+
V3128	(CEJN-) Nippel Hydraulik 1/4"		-	031288
V3199	Hydraulik-Zylinder · 22 Tonnen		-	031998
V3125	Schutzring für Gewinde 1.1/2"		-	031257
V3127	Zugstange · M 18 M 22 · maximal 22 t		250	031271
V3126	Kragenmutter · M 18x2,5		-	031264
V3124	Druckstange · verstellbar M 24		92	031240
V3134	Druckachse M 24x3 mm		151	031349
V3123	Druckfuß M 24x3 mm		-	031233
V3018	Schlagkörper · M 22x2,5 mm		-	030182
V3130	Druckstück · verstellbar M 24		109	031301

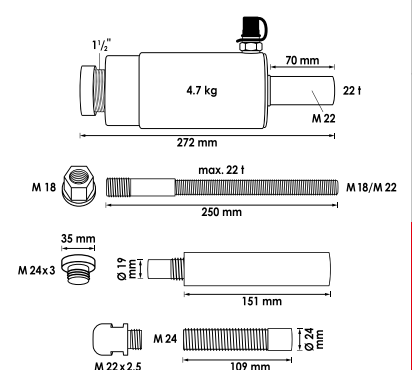

V2874, EAN 4047728028745

Druck- und Zug-Hydraulikzylinder 32 Tonnen

- Ausdrücken von festgerosteten Antriebswellen und Achsschenkelbolzen
- Druck des Hydraulikzylinders kann bei Verwendung eines Schlagkörpers mit Schlagkraft kombiniert werden
- Einsatz mit allen Pkw-Werkzeugen und Zugstangen M 10 – M 22 mit entsprechender Reduzierung



Automatischer Kolbennrücklauf

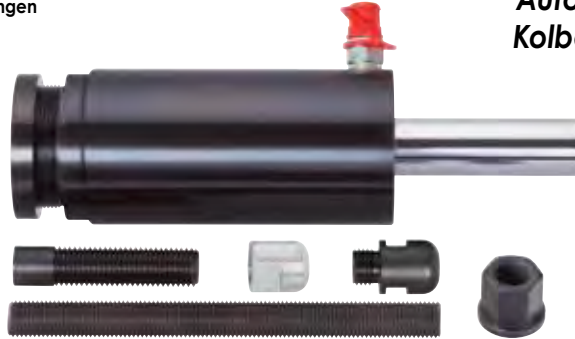

VIGOR No.	Bezeichnung	Ausführung	L mm	EAN 4047728+
V3128	(CEJN-) Nippel Hydraulik 1/4"		-	031288
V3216	Hydraulik-Zylinder · 32 Tonnen		-	032162
V3131	Schutzring für Gewinde 2,5		-	031318
V3130	Druckstück · verstellbar M 24		109	031301
V3092	Schlagmutter		-	030922
V3018	Schlagkörper · M 22x2,5 mm		-	030182
V3133	Zugstange · M 22 · maximal 32 t		250	031332
V3132	Kragennutter · M 22x2,5		-	031325

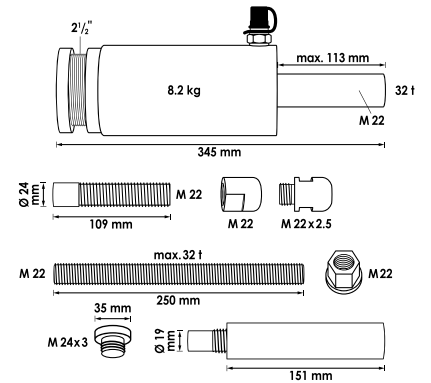

V4229, EAN 4047728042291

Druck- und Zug-Hydraulikzylinder 45 Tonnen

- Ausdrücken von festgerosteten Antriebswellen
- Druck des Hydraulikzylinders kann bei Verwendung eines Schlagkörpers mit Schlagkraft kombiniert werden



Automatischer Kolbennrücklauf

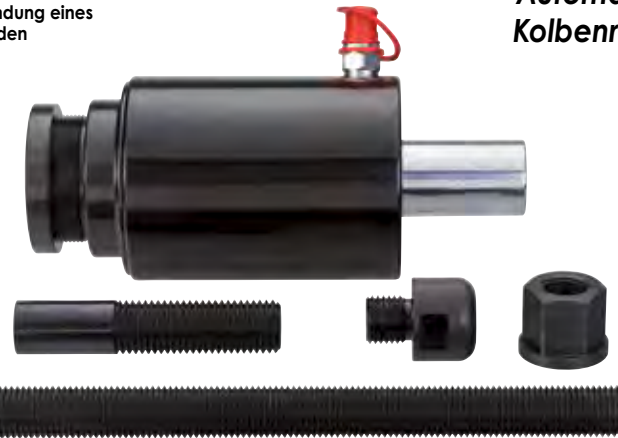

VIGOR No.	Bezeichnung	Ausführung	L mm	EAN 4047728+
V3128	(CEJN-) Nippel Hydraulik 1/4"		-	031288
V4242	Hydraulik-Zylinder 45 Tonnen		-	042420
V3131	Schutzring für Gewinde 2,5		-	031318
V4251	Druckstück · verstellbar · M 30		145	042512
V4254	Schlagkörper · M 27		-	042543
V4252	Kragennutter M 27		-	042529
V4253	Zugstange · M 27 · maximal 50 t		330	042536

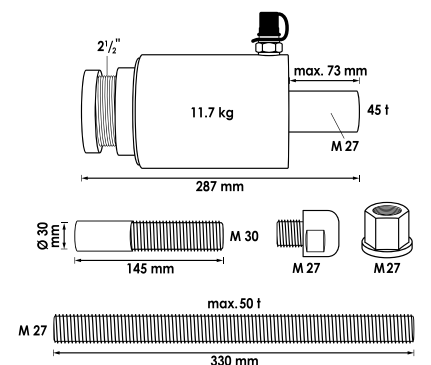

V4218, EAN 4047728**042185**

Halteungs Satz für Hydraulikzylinder

- Verwendung als Handhalter oder mit Getriebeheber
- Für alle handelsüblichen Getriebeheber mit \varnothing von 25 und 30 mm
- Für Hydraulikzylinder V2869 (14 Tonnen) · V2855 (16 Tonnen) · V4551 (18 Tonnen) · V2854 (22 Tonnen) · V2874 (32 Tonnen)
- Auch für Hydraulikzylinder mit 65 – 100 mm \varnothing (z.B. Paschke, Klann)
- Problemloses Justieren und Fixieren des Hydraulikzylinders ermöglicht flexible und schnelle Handhabung bei der Arbeit direkt am Fahrzeug



Lieferung ohne Hydraulikzylinder



VIGOR No.	Bezeichnung	Ausführung	EAN 4047728+
V4244	Schelle \varnothing 70 mm		042444
V4245	Schelle \varnothing 85 mm		042451
V4246	Schelle \varnothing 100 mm		042468
V4243	Halteung ohne Schelle		042437



V3207, EAN 4047728**032070**
Zugstangen-, Kragenmutter
Adapter Satz



VIGOR No.	Bezeichnung	Ausführung	← L → mm		EAN 4047728+
V3210	Zugstange · M 10 · maximal 6 t		150	1	032100
V3220	Zugstange · M 12 · maximal 9 t		250	1	032209
V3136	Zugstange · M 14 · maximal 12 t		250	1	031363
V3127	Zugstange · M 18 M 22 · maximal 22 t		250	1	031271
V3133	Zugstange · M 22 · maximal 32 t		250	1	031332
V3209	Adapter · M 22x2,5 – M 10x1,5		-	1	032094
V3219	Adapter · M 22x2,5 – M 12x1,75		-	1	032193
V3135	Adapter · M 22x2,5 – M 14x2,0		-	1	031356
V3275	Kragenmutter · M 10x1,5		-	1	032759
V3208	Kragenmutter · M 12x1,75		-	1	032087
V3137	Kragenmutter · M 14x2,0		-	2	031370
V3126	Kragenmutter · M 18x2,5		-	1	031264
V3132	Kragenmutter · M 22x2,5		-	1	031325



VIGOR No.	Bezeichnung	Ausführung	EAN 4047728+
V4596*	Adapter · M 18 – M 22		045964
V4597*	Adapter · Innengewinde: M 22x2,5 mm · Außengewinde: M 27x3,0 mm		045971
V4342*	Schlagmutter · M 18		043427

* Nicht im Satz enthalten

V7699, EAN 4047728**076999**
Spindel M22 · M20



V7700, EAN 4047728**077002**
Kragenmutter M20



V2850, EAN 4047728028509

Adapter

- Adaptierung des Klann Hydraulikzylinders mit 17 Tonnen auf das VIGOR-Spezialwerkzeug
- Adapter 2.1/4" – 14 UNS (Klann-Gewinde) auf 1.1/2"



V2851, EAN 4047728028516

Adapter

- Adaptierung des VIGOR Hydraulikzylinders (8,5 Tonnen bis 22 Tonnen) auf das KLANN Spezialwerkzeug
- Adapter 2.1/4" – 14 UNS (Klann-Gewinde) auf 1.1/2"

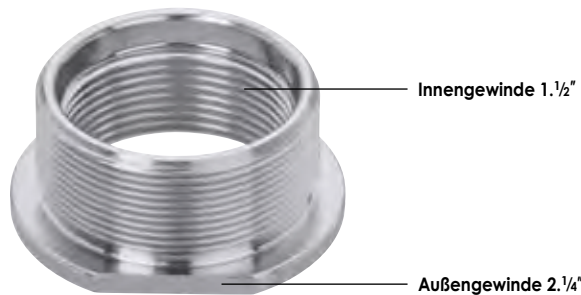

V2910, EAN 4047728029100

Adapter

- Adaptierung der Hydraulikzylinder 16 Tonnen (V2855) und 22 Tonnen (V2854) auf das VIGOR Spezialwerkzeug mit 1.1/2" Gewinde
- Adapter 1.1/2" auf 2.1/2" – 11 UNS

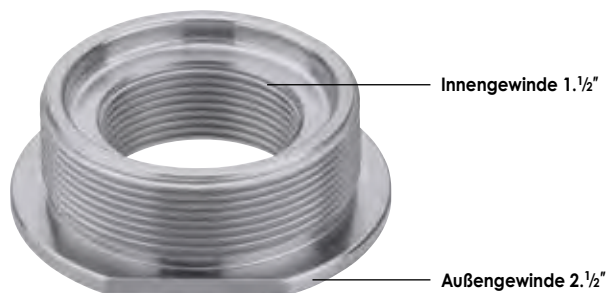

V3869, EAN 4047728038690

Adapter

- Adaptierung des VIGOR Hydraulikzylinders auf das Paschke Spezialwerkzeug
- Adapter M 68x2 mm (Paschke-Gewinde) auf 1.1/2"

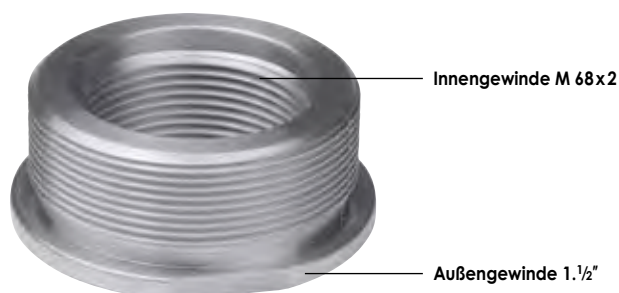

V3870, EAN 4047728038706

Adapter

- Adaptierung des Paschke Hydraulikzylinders auf die VIGOR-Spezialwerkzeuge
- Adapter M 68x2 mm (Paschke-Gewinde) auf 1 1/2" – 11

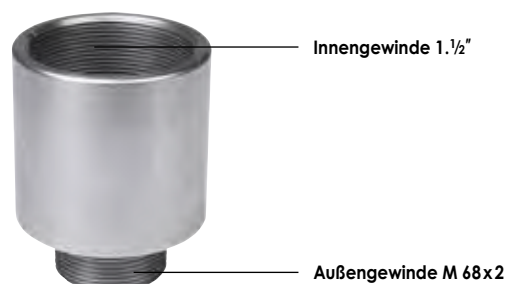

V4220, EAN 4047728**042208**

Adapter

- Adaptierung des Klann Hydraulikzylinders mit 28 Tonnen auf das VIGOR-Spezialwerkzeug
- Adapter 2.3/4" - 14 UNS (Klann-Gewinde) auf 2.1/2"

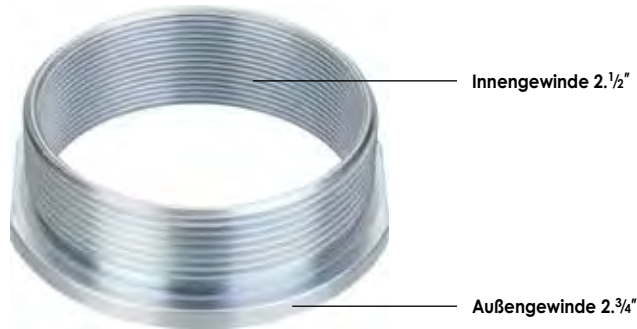

V3582, EAN 4047728**035828**

Einklemmschutz

- Schutz beim Arbeiten mit Hydraulikzylindern in Verbindung mit Spezialwerkzeugen



V3612, EAN 4047728**036122**

Manometer

- Anschlussstück und Nippel zur direkten Ankopplung an allen hydraulischen Pumpen von VIGOR
- Angaben des maximalen Druckbereichs der Hydraulikzylinder finden Sie in der jeweiligen Betriebsanleitung



V6592, EAN 4047728**065924**

Adapter 3/8" Innengewinde · auf CEJN / Pumpe

- Adaptieren von z.B. Klann oder Sauer Hydraulikpumpen auf den CEJN-Anschluss
- Schnelle, einfache Verbindungsart
- Tropffrei, ohne Ölverlust
- Schützt vor Eindringen von Luft in das System
- CEJN Anschlüsse sind kleiner als herkömmliche Verbindungen - für beengte Platzverhältnisse
- Flexibel, leichte Arretierungen sind ohne Verspannungen möglich

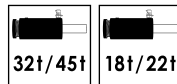

V6591, EAN 4047728**065917**

Adapter 3/8" Außengewinde · auf CEJN / Zylinder

- Adaptieren von z.B. Klann oder Sauer Hydraulikzylinder auf den CEJN-Anschluss
- Schnelle, einfache Verbindungsart
- Tropffrei, ohne Ölverlust
- Schützt vor Eindringen von Luft in das System
- CEJN Anschlüsse sind kleiner als herkömmliche Verbindungen - für beengte Platzverhältnisse
- Flexibel, leichte Arretierungen sind ohne Verspannungen möglich

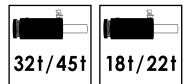

V2853, EAN 4047728028530

Spindel Satz · mechanisch

- Mechanische Spindel für Werkzeug-Sätze · V2865 · V2845 · V2848 · V2860 · V2870 · V4491 · V4629 · V2860 · V3731 und V3732
- 330 mm Länge ist ausreichend für fast alle auszuführenden Arbeiten

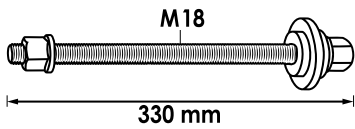

VIGOR No.	Bezeichnung	Ausführung	→ L ← mm	EAN 4047728+
V3126	Kragenmutter · M 18x2,5		-	031264
V3008	Zugstange mit Kragenmutter M 18		330	030083
V3206	Unterlegscheibe		-	032063
V3205	Druckscheibe		-	032056



V4699, EAN 4047728046992

Druckspindel Satz · manuell

- Manueller Druckspindel Satz zur mechanischen Betätigung von Spezialwerkzeugen
- Im Satz enthalten sind vier verschiedenen lange Druckstangen, mit denen der Gebrauch von unterschiedlichen Werkzeugen gewährleistet wird
- Verwendung mit V3072 · V2858N · V3147 · V3649 · V3148 · V2885 · V2920 und V2937
- Spindel und Adapter sind extra für die pneumatisch unterstützte Betätigung ausgelegt, sodass beispielsweise das Arbeiten mit einem Schlagschrauber bis maximal 1000 Nm Anzugsmoment möglich ist
- Effektive Kraftübertragung der Spindel liegt bei maximal 15 Tonnen
- Bei häufigen Arbeiten mit Tragelenken, Buchsen sowie Antriebswellen empfehlen wir die Verwendung des Hydraulikzylinders 8,5 – 22 Tonnen



VIGOR No.	Bezeichnung	Ausführung	EAN 4047728+
V4699-3	Scheibe Ø 18,8x3 mm (4 Stk.)		047029
V4699-4	Press-Achse · 50xØ 19 mm		047036
V4699-5	Press-Achse · 85xØ 19 mm		047043
V4699-6	Press-Achse · 56xØ 24 mm		047050
V4699-7	Press-Achse · 100xØ 24 mm		047067
V4699-1	Druckspindel · M 30		047005
V4699-2	Adapter · 1.½" · M 30		047012



V2867N, EAN 4047728077859

Sicherungsring-Werkzeug

- Erleichtert Ausbau von häufig fest gerosteten innenseitigen Sicherungsringen an Radlagern
- Aussparungen an Stellschraube für 6,3 mm (1/4") Ratsche für maximale Kraft und schnellen Ausbau
- Für Pkw, Transporter und Lkw
- Einzigartige Konstruktion ermöglicht unabhängig von Sicherungsring-Größe stets den richtigen Winkel des Stifts
- Einfacher, schneller Wechsel der Stifte
- Spitzen auch seitlich zu positionieren
- Optimierte Bauform für schwer zugängliche Bereiche



NEU



5 – 95 mm Spannbereich



Ersatzstifte für V2867N

VIGOR No.	Bezeichnung		EAN 4047728+
V2992	Stift Ø 2,5 mm	4	029926
V2993	Stift Ø 3,0 mm	4	029933
V2994	Stift Ø 3,5 mm	4	029940

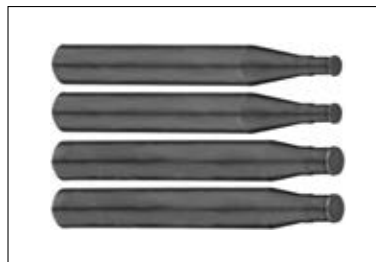



V2846, EAN 4047728028462
Hydraulikpumpe · pneumatisch

- Für alle Hydraulikzylinder
- Inklusive Öl-Messstab



**Ausführung inklusive
 Manometer**

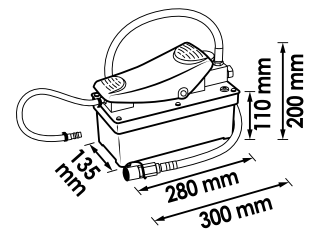

VIGOR No.	Bezeichnung	Ausführung	EAN 4047728+
V3120	2,2 m Hydraulikschlauch 1/4"		031202
V3141	(CEJN-) Schnellkupplung		031417
V4255	Manometer		042550

V2847, EAN 4047728028479
Hydraulische Fußpumpe

- Für alle Hydraulikzylinder

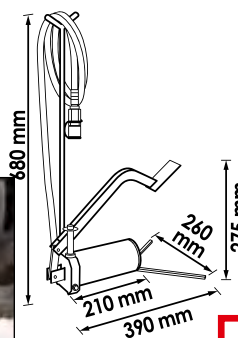
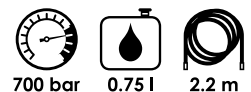

VIGOR No.	Bezeichnung	Ausführung	EAN 4047728+
V3120	2,2 m Hydraulikschlauch 1/4"		031202
V3614	Dichtungssatz		036146
V3141	(CEJN-) Schnellkupplung		031417



V4629, EAN 4047728046299

Radnaben Demontage-Werkzeug · universal

- Effektive Methode zur Demontage von Radnaben.
Empfehlung: Verwendung Radlager Satz V4598
- Funktion auch bei Achsschenkeln mit unebenen und begrenzten Flächen
- Deutliche Zeitersparnis zu bisherigen Systemen

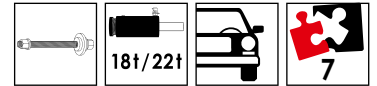

VIGOR No.	Bezeichnung	Ausführung	xx	EAN 4047728+
V3873	Fixierschraube · M 14		2	038737
V3874	Schraube · M 12		2	038744
V3871	Traverse für diverse Druckfüsse		1	038713
V4629-1	Druckfuß Satz für V4629		2	046305



V2845, EAN 4047728028455

Lager- und Nabenschale

- Für Radlager und Nabe an z.B.:
 - FORD: C-Max
 - MAZDA: 3
 - Volvo: S40 · V50
 - ŠKODA: Octavia 1996 → 2004
 - VW: Golf 4 · Bora · Beetle
 - AUDI: A3 · S3 · TT 1999 → 2006
 - SEAT: León 1 · Toledo 2
- Sowie bestimmte Modelle von CITROËN · PEUGEOT · RENAULT und VAG mit geteilter Radlager/Nabe
- (Hinweis: Normaler Pressbügel passt hier nicht)
- Verwendung zusammen mit V4629



VIGOR No.	Bezeichnung	Ausführung	mm	EAN 4047728+
V3040	Druckrohr · groß		120	030403
V3039	Druckscheibe · groß		-	030397



V4598, EAN 4047728**045988**

Radlager-, Antriebsachsen und Radnaben Satz · universal

- Wechslen des Radlagers direkt am Fahrzeug bei minimalem Zeitaufwand
- In Verbindung mit Hydraulikzylinder oder manueller Spindel
- Alle Teile sind für die heute auf dem Markt befindlichen Radlagergrößen angepasst
- Die Montagescheiben haben eine Führung und sind zweiseitig verwendbar
- Montagescheiben mit $\varnothing 62 - 83$ mm und Nabenscheiben $34 - 60$ mm sind enthalten, die Lagerschale ist für Radlager bis 92 mm \varnothing
- Demontage der Radnabe mit V4629 · V2849 und V3072
- Arbeitszeit: circa 20 - 30 Minuten je Seite
- Radeinstellung oder Bremsanlagen-Entlüftung nicht erforderlich
- Kein Ausbau von ABS-Geber, Achsschenkel, Federbein oder Spurstangengelenk

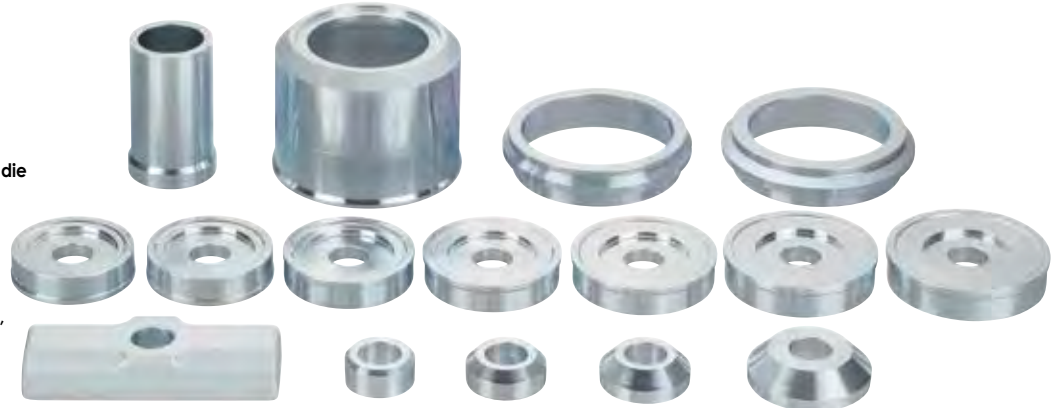

VIGOR No.	Bezeichnung	Ausführung	l mm	EAN 4047728+
V4598-30	Druckrohr Länge 78 mm für V4598 · V4599		78	046282
V4598-22	Lagerschale $\varnothing 93$ mm für V4598		-	046275
V4598-21	Lagerschale $\varnothing 75,5$ mm für V4598		-	046268
V4598-20	Lagerschale $\varnothing 93$ mm für V4598		-	046251
V4598-10	Lagerscheibe $\varnothing 61,8 - 62,8$ mm · Innenloch- $\varnothing 20,25$ mm · passend für Spindel M 20		-	046183
V4598-11	Lagerscheibe $\varnothing 63,8 - 64,8$ mm · Innenloch- $\varnothing 20,25$ mm · passend für Spindel M 20		-	046190
V4598-12	Lagerscheibe $\varnothing 65,8 - 66,8$ mm · Innenloch- $\varnothing 20,25$ mm · passend für Spindel M 20		-	046206
V4598-13	Lagerscheibe $\varnothing 68,8 - 70,8$ mm · Innenloch- $\varnothing 20,25$ mm · passend für Spindel M 20		-	046213
V4598-14	Lagerscheibe $\varnothing 72,5 - 74,5$ mm · Innenloch- $\varnothing 20,25$ mm · passend für Spindel M 20		-	046220
V4598-15	Lagerscheibe $\varnothing 76,5 - 78,5$ mm · Innenloch- $\varnothing 20,25$ mm · passend für Spindel M 20		-	046237
V4598-16	Lagerscheibe $\varnothing 80,8 - 82,8$ mm · Innenloch- $\varnothing 20,25$ mm · passend für Spindel M 20		-	046244
V3060	Gegenhalter		-	030601
V4614	Nabenscheibe · konisch · $\varnothing 33,8$ mm · für V4598		-	046145
V4598-2	Nabenscheibe · konisch · $\varnothing 38,8$ mm · für V4598		-	046152
V4598-3	Nabenscheibe · konisch · $\varnothing 43,8$ mm · für V4598 · V4599		-	046169
V4598-4	Nabenscheibe · konisch · $\varnothing 59,8$ mm · für V4598		-	046176



V4599, EAN 4047728045995

Radlager Satz AUDI Q7 · VW Touareg · PORSCHE Cayenne

- Radlagerwechsel an der Vorderachse
- Bei AUDI Q7 · VW Touareg · PORSCHE Cayenne
- Auswechseln des Radlagers an der Hinterachse bei AUDI Q7
- Form der Werkzeuge gewährleistet keine Beschädigung des ABS-Gebers
- Ergänzung Demontage Radnabe: V4629
- Ergänzung Demontage Radlager: V2860
- Begrenzung des Zeitaufwands auf circa 30 Minuten
- Radlagerwechsel direkt am Fahrzeug ohne zeitaufwendigen Ausbau

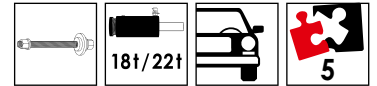

VIGOR No.	Bezeichnung	Ausführung	← L → mm	EAN 4047728+
V3071	Lagerscheibe Ø 95 mm · Innenloch-Ø 20,25 mm · passend · für Spindel M 20		-	030717
V4598-30	Druckrohr Länge 78 mm für V4598 · V4599		78	046282
V3070	Lagerscheibe Ø 92 mm		-	030700
V4598-12	Lagerscheibe Ø 65,8 – 66,8 mm · Innenloch-Ø 20,25 mm · passend für Spindel M 20		-	046206
V4598-3	Nabenscheibe · konisch · Ø 43,8 mm · für V4598 · V4599		-	046169



V4594, EAN 4047728045940

Radlager-Fixierung · verstellbar

- Radlager, die nach innen ausgebaut werden
- Platte ermöglicht optimale Einstellung auf schiefer / ungleichmäßiger Oberfläche der Innenseite, so dass eine ebene Pressfläche entsteht
- Einsatz mit Hydraulikzylinder, mechanischer Spindel oder Werkstattpresse
- Verwendung zusammen mit V4629
- Demontage des Radlagers mit V4598
- An z.B.
 - CITROËN: Berlingo (Bj. 1996 →), Jumpy (Bj. 1995 →)
 - RENAULT: Clio (Bj. 1991 → 2012)
 - FIAT: Scudo (Bj. 1995 →)
 - PEUGEOT: Partner (Bj. 1996 →), Expert (Bj. 1995 →)
 - KIA: Rio (2001 → 2005), Ceéd (2006 → 2012)
 - HYUNDAI: i30 (Bj. 2007 →)

Universal Fixierung für alle Lager, die nach hinten ausgepresst werden



VIGOR No.	Bezeichnung	Ausführung		EAN 4047728+
V4594-1	Druckfuß Satz für V4594		2	045957
V3060	Gegenhalter		1	030601



V2860, EAN 4047728028608

Kompakt-Radlager Demontage Satz · universal

- Demontage Kompakt-Radlager mit oder ohne Sicherungsring
- Für z.B.:
 - VW: Polo · Lupo · Touareg · Fox · T5 vorne und hinten · Crafter
 - AUDI: A2
 - SEAT: Ibiza · Córdoba
 - ŠKODA: Fabia · Rapid · Roomster
 - FORD: Focus · C-Max · Mondeo · S-Max · Kuga
 - LANDROVER: Freelander 2
 - MAZDA: 3 · 5 · 6 · CX-7
 - MERCEDES-BENZ: Sprinter · Vito · Viano
 - MITSUBISHI: Colt
 - SMART: Forfour
 - Volvo: V50 · S40 · V70 · S80 · XC60
- Demontage der Radnabe an Pkw
- Ermöglicht den Einsatz mit mechanischer Spindel



Verstellbarkeit gewährleistet Einsatz aller zur Zeit auf dem Markt erhältlichen sowie zukünftiger Kompakt-Radlager Typen

VIGOR No.	Bezeichnung	Ausführung	XX	EAN 4047728+
V3873	Fixierschraube · M 14		2	038737
V3874	Schraube · M 12		2	038744
V3871	Traverse für diverse Druckfüsse		1	038713
V3755	Druckfuß Satz (Demontage) für Kompakt-Radlager		2	037556



V7050, EAN 4047728070508

Demotagewerkzeug für geschraubte 4-Loch Naben / Radlager mit unebenem Bremsschutzblech

- Flexibel einstellbar, besonders für Modelle mit schwer zugänglichem Bremsschutzblech
- Demontage direkt am Fahrzeug
- Aufgrund von Korrosions-Einwirkungen sitzen diese Radlagerarten sehr fest und sind schwierig zu demontieren. Die Verwendung des Werkzeugs vermeidet Beschädigung der Achsschenkelteile oder des Bremsschutzblechs
- Für z.B.: SUBARU Forester · XV · Outback
TOYOTA Aygo 2006 → 2019 · Avensis
CITROËN C1
PEUGEOT 107 · 108
OPEL Vectra · Zafira
CHRYSLER Voyager
HYUNDAI I10
SUBARU diverse Modelle



V2864, EAN 4047728028646

Demontagescheibe · konisch · universal

- Konische Scheibe zur Demontage von Kompakt-Radlagern



Innendurchmesser 20,25 mm
passend für M 20 Spindel

Passend für alle Größen



V6824, EAN 4047728068246

Halbschalen Satz für die Montage von 92 mm Kompakt-Radlager

- Radlagerwechsel direkt am Fahrzeug, ohne Demontage des Achsschenkels
- Fachmännische Montage mit Hilfe eines speziellen Adapterring vermeidet innere Schäden am Kompakt-Radlager durch unsachgemäße Montage und Druck auf Radnaben
- Demontage des Radlagers auch in Verbindung mit dem Werkzeugen V2860 · V2864 · V5027
- Montage mit Werkzeugen V4491 · V2862
- Zusätzlich werden hydraulische oder manuelle Antriebswerkzeuge benötigt
- Für u.a.:
 - PEUGEOT Expert · Traveller Bj. 2016 →
 - CITROËN Spacetourer Bj. 2016 →
 - TOYOTA Proace · Proace Verso Bj. 2016 →

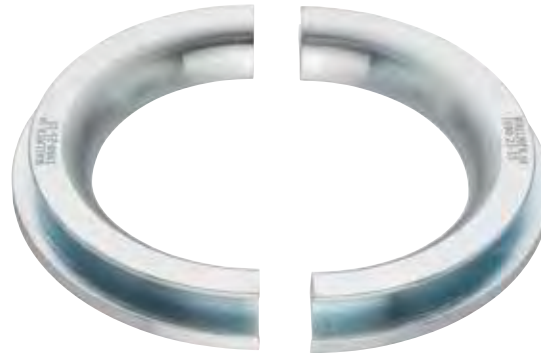

V3731, EAN 4047728037310

Demontage Satz, universal, für geschraubte Radlagereinheit

- Demontage geschraubte Radlagereinheiten (4 Bolzen) an Vorder- und Hinterachse
- Beidseitige Verwendung der Druckfüße gewährleistet einfache und schnelle Justierung am Achsschenkel
- Maximale Belastbarkeit: 22 Tonnen
- Verstellbarkeit gewährleistet Einsatz aller zur Zeit auf dem Markt erhältlichen geschraubten Radlagereinheiten mit 4 Bolzen
- Direkt am Fahrzeug einsetzbar
- Für: VAG · FORD · MAZDA · TOYOTA · MITSUBISHI · AUDI A4 · A6 · VW Passat · ŠKODA Octavia · SEAT Exeo etc.

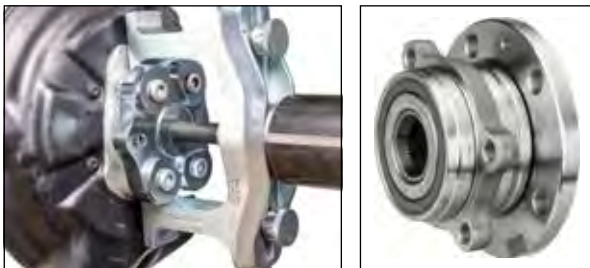

VIGOR No.	Bezeichnung	Ausführung	XX	EAN 4047728+
V3873	Fixierschraube · M 14		2	038737
V3874	Schraube · M 12		2	038744
V3871	Traverse für diverse Druckfüße		1	038713
V3758	Druckfuß Satz (Demontage) für geschraubte Radlagereinheiten		2	037587

Universell einstellbar für geschraubte Radlagereinheiten mit 4 Bolzen

V3732, EAN 4047728037327

Demontage Satz, universal, für geschraubte Radlagereinheit

- Demontage geschraubte Radlagereinheiten (3 Bolzen) an Vorder- und Hinterachse
- Beidseitige Verwendung der Druckfüße gewährleistet einfache und schnelle Justierung am Achsschenkel
- Maximale Belastbarkeit: 22 Tonnen
- Verstellbarkeit gewährleistet Einsatz aller zur Zeit auf dem Markt erhältlichen geschraubten Radlagereinheiten mit 3 Bolzen
- Direkt am Fahrzeug einsetzbar
- Für z.B.:
 - VW Golf 6 Cabrio Bj. 2013 → · Golf Bj. → 2012 · Touran Bj. 2015 → · Tiguan Bj. 2016 → · Passat Bj. 2014 →
 - AUDI A3 Bj. 2012 → · TT Bj. 2014 → · Q2 Bj. 2016 →
 - ŠKODA Octavia Bj. 2012 → · Superb Bj. 2015 →
 - SEAT León Bj. 2012 →
 - OPEL Insignia · Astra Bj. 2004 → · Corsa D → 2014
 - CHEVROLET/GMC Malibu
 - SAAB 95 Bj. 2010 →

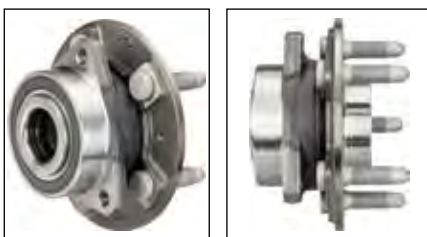

VIGOR No.	Bezeichnung	Ausführung	XX	EAN 4047728+
V3873	Fixierschraube · M 14		2	038737
V3874	Schraube · M 12		2	038744
V3871	Traverse für diverse Druckfüße		1	038713
V3753	Druckfuß Satz (Demontage) für geschraubte Radlagereinheiten		2	037532

Universell einstellbar für geschraubte Radlagereinheiten mit 3 Bolzen

V5420, EAN 4047728075275

Standard Radlager Demontage / Montage Satz ROVER

- Demontage / Montage von Radlagern und Radnaben an ROVER
- Speziell angepasste AusbaufüÙe für stabilen und beschädigungsfreien Halt am Achsschenkel
- Aussparungen an Gegenhalteplatte – ABS Sensoren bleiben unberührt und müssen nicht getauscht werden
- Mit Adapterplatte zum Lösen des Sicherungsringes
- Für z.B.: Land Rover Discovery Sport L494 2013 → 2019 · Defender L663 2020 → · Discovery Sport L550 2019 → · Discovery 5 L462 2017 → · Range Rover Sport L494 2013 → · Vogue L405 2012 → · Evoque L538 2011 → · Velar L560 2017 →



V5425, EAN 4047728075596

Standard Radlager Erweiterungssatz ROVER

- Demontage / Montage von Radlagern und Radnaben an ROVER
- Speziell angepasste AusbaufüÙe für stabilen und beschädigungsfreien Halt am Achsschenkel
- Aussparungen an Gegenhalteplatte – ABS Sensoren bleiben unberührt und müssen nicht getauscht werden
- Mit Adapterplatte zum Lösen des Sicherungsringes
- Für z.B.: Land Rover Discovery Sport L494 2013 → 2019 · Defender L663 2020 → · Discovery Sport L550 2019 → · Discovery 5 L462 2017 → · Range Rover Sport L494 2013 → · Vogue L405 2012 → · Evoque L538 2011 → · Velar L560 2017 →
- Für Vorder- und Hinterachse
- Hinweis: Zur vollständigen Bearbeitung wird Traverse V3871 inklusive Verschraubungen benötigt

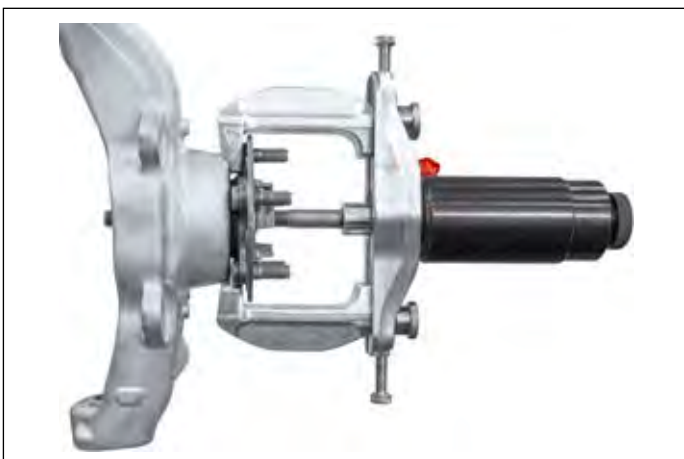

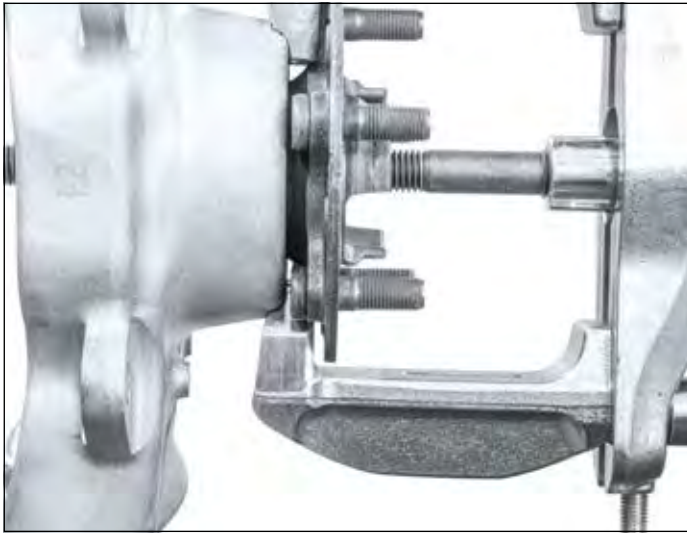

V5421, EAN 4047728075282

Erweiterungssatz

- Demontage / Montage von Radlagern und Radnaben an ROVER
- Speziell angepasste AusbaufüÙe für stabilen und beschädigungsfreien Halt am Achsschenkel
- Aussparungen an Gegenhalteplatte – ABS Sensoren bleiben unberührt und müssen nicht getauscht werden
- Mit Adapterplatte zum Lösen des Sicherungsring
- Für z.B.: Land Rover Discovery Sport L494 2013 → 2019 · Defender L663 2020 → · Discovery Sport L550 2019 → · Discovery 5 L462 2017 → · Range Rover Sport L494 2013 → · Vogue L405 2012 → · Evoque L538 2011 → · Velar L560 2017 →
- Druckfuß Paar



V5423, EAN 4047728075312

Halteplatte

- Demontage / Montage von Radlagern und Radnaben an ROVER
- Speziell angepasste AusbaufüÙe für stabilen und beschädigungsfreien Halt am Achsschenkel
- Aussparungen an Gegenhalteplatte – ABS Sensoren bleiben unberührt und müssen nicht getauscht werden
- Mit Adapterplatte zum Lösen des Sicherungsring
- Für z.B.: Land Rover Discovery Sport L494 2013 → 2019 · Defender L663 2020 → · Discovery Sport L550 2019 → · Discovery 5 L462 2017 → · Range Rover Sport L494 2013 → · Vogue L405 2012 → · Evoque L538 2011 → · Velar L560 2017 →
- Halteplatte · Ø 89-105 mm

Ø 86 – 105 mm



V5422, EAN 4047728075466

Lagerplatte

- Demontage / Montage von Radlagern und Radnaben an ROVER
- Speziell angepasste AusbaufüÙe für stabilen und beschädigungsfreien Halt am Achsschenkel
- Aussparungen an Gegenhalteplatte – ABS Sensoren bleiben unberührt und müssen nicht getauscht werden
- Mit Adapterplatte zum Lösen des Sicherungsring
- Für z.B.: Land Rover Discovery Sport L494 2013 → 2019 · Defender L663 2020 → · Discovery Sport L550 2019 → · Discovery 5 L462 2017 → · Range Rover Sport L494 2013 → · Vogue L405 2012 → · Evoque L538 2011 → · Velar L560 2017 →
- Lagerplatte · Ø 85-95 mm

Ø 85 – 95 mm



V5424, EAN 4047728075329

Lagerplatte

- Demontage / Montage von Radlagern und Radnaben an ROVER
- Speziell angepasste AusbaufüÙe für stabilen und beschädigungsfreien Halt am Achsschenkel
- Aussparungen an Gegenhalteplatte – ABS Sensoren bleiben unberührt und müssen nicht getauscht werden
- Mit Adapterplatte zum Lösen des Sicherungsring
- Für z.B.: Land Rover Discovery Sport L494 2013 → 2019 · Defender L663 2020 → · Discovery Sport L550 2019 → · Discovery 5 L462 2017 → · Range Rover Sport L494 2013 → · Vogue L405 2012 → · Evoque L538 2011 → · Velar L560 2017 →
- Lagerplatte · Ø 95 mm

Ø 95 mm



V2859, EAN 4047728028592

Gegenhalteplatte (Montage) FORD · MAZDA · Volvo

- Für z.B.:
 - FORD: Mondeo, Focus, C-Max, S-Max, Kuga
 - MAZDA: 3 bis 6 · 5 · CX7
 - Volvo: V70 Bj. 2007 →, S40 · V50 Bj. 2004 →
 - LANDROVER: Freelander 2-14



Innendurchmesser 20,25 mm
für M 20 Spindel geeignet



V2863, EAN 4047728028639

Montagering FORD · MAZDA · Volvo

- Tieferes Einpressen des Kompakt-Radlagers in das Radlagergehäuse
- Für z.B.:
 - FORD: Mondeo · S-Max
 - MAZDA: 6
 - Volvo: V70 Bj. 2007 → · S80 · V60 · XC60 · XC70



V2862, EAN 4047728028622

Gegenhalteplatte (Montage) VW

- Für z.B.:
 - VW: T5 vorne und hinten, Touareg
 - MERCEDES-BENZ: Vito und Viano Hinterachse



Innendurchmesser 20,25 mm
für M 20 Spindel geeignet



V2861, EAN 4047728028615

Gegenhalteplatte (Montage) VW · AUDI · SEAT · ŠKODA

- Für z.B.:
 - VW: Polo, Lupo, Fox
 - AUDI: A2
 - SEAT: Ibiza, Córdoba
 - ŠKODA: Fabia
 - SMART: Forfour
 - MITSUBISHI: Colt



V5027, EAN 4047728050272

Radnaben-Abzieher

- Demontage geschraubte Radlagereinheiten mit geschlossener Nabe
Antriebswelle muss nicht mehr vorher entfernt werden
- Verwendung in Verbindung mit Radlager- / Nabenwerkzeug V3731 · V3732 · V2860 sowie Hydraulikzylinder 16 – 22 Tonnen
- Lochkreis 4- und 5-Loch: 92 – 131 mm
- Hinweis: Werkzeug nicht mit mehr als 18 Tonnen belasten
- Für Modelle mit geschlossener Nabe, u.a.:
 - OPEL Insignia Bj. 2010 →
 - SAAB 9-5 Bj. 2010 →
 - CITROËN C1 Bj. 2006 → Jumpy Bj. 2016 → · SpaceTourer Bj. 2016 →
 - PEUGEOT 108 Bj. 2015 → Expert Bj. 2016 → · Traveller
 - TOYOTA Aygo Bj. 2006 → · ProAce (Verso)



Radnaben-Demontage ohne vorheriges Ausbauen der Antriebswelle



V7061, EAN 4047728070614

Schrauben Satz · SUBARU · Hinterradlager

- Demontage des hinteren Radlagers am SUBARU mit Werkzeug V5903N erfordert längere Lagerbolzen
- Satz bestehend aus 4 Sechskant-Schrauben M 12x1,25x100 mm für das Gewinde des Lagers
- Unterlegscheiben mit flacher Seite zum Schraubenkopf verwenden
- Für z.B. SUBARU Legacy · Impreza · Forester · Outback · XV



Radlager-Abzieher V5903N optional erhältlich

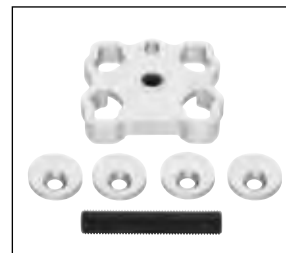

V7071, EAN 4047728078610

Schrauben Satz · VAG

- Demontage von Radlagern der Generation 3 (geschraubt und geteilt) bei diversen VAG Achsschenkeln z.B.: AUDI: A6 · A7
- Originale Verschraubungen der Radlager können nicht für die Demontage verwendet werden
- Schrauben Satz nur in Kombination mit dem Radlager-Abzieher V5903N verwendbar
- Inhalt: 4x Sechskant-Schraube M12x1,5x60 mm



NEU



V5903N, EAN 4047728**075237**

Radlager-Abzieher

- Demontage geschraubter Radlagereinheiten (mit 3 oder 4 Bolzen) an Vorder- und Hinterachse bei demontierter Radnabe
- Nur in Verbindung mit V3731 und V3732
- Direkt am Fahrzeug einsetzbar
- Maximale Belastbarkeit: 18 Tonnen
- Für z.B. AUDI A4 Bj. 2007 → 2016 · A5 Bj. 2007 → 2017 · A6 Bj. 2011 → · A7 Bj. 2010 → · A8 Bj. 2010 → · Q5 Bj. 2008 →



VIGOR No.	Bezeichnung	Ausführung	EAN 4047728+
V5903-3	Zugstange - M 22 · 121 mm		059077



V4491, EAN 4047728**044912**

Kompakt-Radlager Montage Satz · universal

- Montage Kompakt-Radlager mit oder ohne Sicherungsring
- Maximale Belastbarkeit: 22 Tonnen
- An z.B.:
 - VW: Polo · Lupo · Touareg · Fox · T5 vorne und hinten · Crafter
 - AUDI: A2
 - SEAT: Ibiza · Córdoba
 - ŠKODA: Fabia · Rapid · Roomster
 - FORD: Focus · C-Max · Mondeo · S-Max · Kuga
 - LANDROVER: Freelander 2
 - MAZDA: 3 · 5 · 6 · CX-7
 - MERCEDES-BENZ: Sprinter · Vito · Viano
 - MITSUBISHI: Colt
 - SMART: Forfour
 - Volvo: V50 · S40 · V70 · S80 · XC60
- Einsatz mit Hydraulikzylinder, mechanischer Spindel oder Werkstattpresse



**Verstellbarkeit
gewährleistet
Einsatz an allen zur
Zeit auf dem Markt
erhältlichen sowie an
zukünftigen Kompakt-
Radlager Typen**

VIGOR No.	Bezeichnung	Ausführung	XX	EAN 4047728+
V3873	Fixierschraube · M 14		2	038737
V3874	Schraube · M 12		2	038744
V3871	Traverse für diverse Druckfüsse		1	038713
V4493	Druckfuß (Paar) für Kompakt-Radlager-Montagewerkzeug Satz · universal		2	044936



V5906, EAN 4047728**059183**

Radlagereinheit · geschraubt · Demontage Satz · universal

- Demontage geschraubte Radlager mit 3 / 4 Bolzen
- Speziell konstruierte Pressfüße erlauben Demontage der Radlager bei SUV und US Pickups
- Radnaben von Größen bis 180 mm sind durch die verstellbare Traverse demontierbar
- Erhitzen der Bauteile und die dadurch verbundene Beschädigung wird ausgeschlossen
- Durch die zusätzliche Verwendung von V5905 ist die Demontage der Antriebswelle nicht notwendig
- Für: DODGE · CHEVROLET/GMC · FORD Ranger Bj. 2011 →



**SUV / VAN Radnaben
mit 6 und 8 Stehbolzen
Universell einstellbar
bis maximal 180 mm
im Durchmesser**

VIGOR No.	Bezeichnung	Ausführung	XX	EAN 4047728+
V3873	Fixierschraube · M 14		2	038737
V3874	Schraube · M 12		2	038744
V3871	Traverse für diverse Druckfüsse		1	038713
V5906-1	Druckfuß Satz		2	059190



V5905, EAN 4047728059152

Radnaben- / Radlager- Abzieher · für 6 und 8 Bolzen

- Demontage verschraubte Radlager und Nabeneinheiten direkt am Fahrzeug
- Nur in Verbindung mit V5906 und V2860
- Demontage einer geschlossenen Nabe
- Demontieren der Antriebswelle nicht notwendig
- Die mitgelieferten M 22-Gewindestangen verbinden das Werkzeug mit einem unserer Hydraulikzylinder
- Für Lochkreis (6 Loch) 111,5 – 142,5 mm, (8 Loch) 162,5 – 182,5 mm

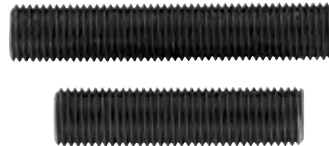

V7027, EAN 4047728075244

Radnaben- / Lagerabzieher

- Demontage geschraubter Radlager mit geschlossener Nabe an Pick-Ups und Transportern
- Nur in Verbindung mit V3731 · V3732 · V2860 und Hydraulikzylinder 16 t bis 22 t
- Lochkreis 4- und 5-Loch: 120 – 170 mm
- Für Modelle mit geschlossener Nabe: DODGE Ram 1500 · FORD Transit



V7859, EAN 4047728078597

Radlager Demontage Satz · Steckachsen

- Effizientes und sicheres Trennen des Radlagers von der Halbachse direkt am Fahrzeug
- Die Nabenachse wird mithilfe des Radnaben-Abziehers aus dem Radlager nach vorne demontiert
- Durch spezielle Auflage-Elemente wird eine Beschädigung des Bremshitzeschildes vermieden
- Für z.B.:
VW Amarok Bj. 2010→
MITSUBISHI L200 Bj. 2006→
TOYOTA Hilux Bj. 2005→



NEU



VIGOR No.	Bezeichnung	Ausführung		EAN 4047728+
V7860	Abstützbacken Satz		2	078603
V5905	Radnaben- / Radlager-Abzieher · für 6 und 8 Bolzen		3	059152
V5027	Radnaben-Abzieher		3	050272
V5906	Radlagereinheit · geschraubt · Demontage Satz · universal		7	059183



V5904, EAN 4047728059084

Antriebswellen-Auspressvorrichtung · 6- und 8-Loch

- Auspressen von verrosteten oder geklebten Antriebswellen direkt am Fahrzeug
- Für Lochkreis (6 Loch) 114 – 140 mm, (8 Loch) 165 bis 180 mm
- Antriebswelle mit 22 Tonnen Hydraulikzylinder auspressen (Montage des Schlagkörpers ermöglicht zusätzliche Kraftaufbringung über Einsatz eines Hammers)
- Befestigung mit den am Fahrzeug vorhandenen Radmütern oder Radschrauben



Einstellbar, passend für Lochkreis (6-Loch) von 114 bis 140 mm und (8-Loch) von 165 bis 180 mm

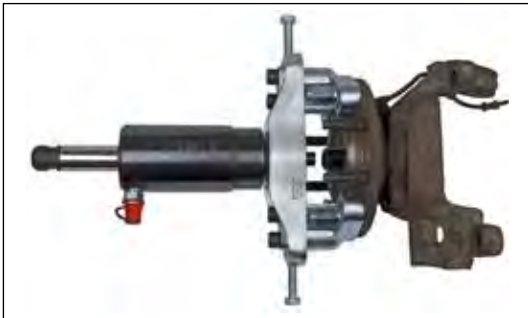

VIGOR No.	Bezeichnung	Ausführung	XX	EAN 4047728+
V5904-1	Druckfuß Satz		2	059114
V3871	Traverse für diverse Druckfüße		1	038713
V5904-3	Gleiteller		4	059138
V5904-4	Schraube · M 14 × 2 – 45 · Innensechskant		2	059145



V7154N, EAN 4047728071772

Erweiterungssatz für Bremsscheiben-Ausdrückwerkzeug · ohne Traverse

- Trennen von stark verrosteten und auf der Radnabe festsitzenden Bremsscheiben
- Auspress-Füße übertragen gleichmäßigen Druck auf die Bremsscheibe
- Gleichmäßige Kraftverteilung über vier Füße an die Bremsscheibe minimiert Beschädigungsrisiko
- Empfehlung: Verwendung eines Hydraulik-Zylinders, z.B. V4551 oder V2854
- Alternative Anwendung mit V4699
- In Verbindung mit der Traverse V3871 zu benutzen, welche nicht enthalten ist zusätzlich benötigt wird
- inklusive Fixierplatten, Auszieh-Füßen, Schrauben, Unterlegplatten
- Spannweite: 260 – 330 mm
- Maximale Belastbarkeit: 22 t



V5128, EAN 4047728051286

Standard Radlager / Radnaben Demontage / Montage Satz

- Inklusive Multibox
- Effektive Methode zur Demontage von Radnaben. Empfehlung: Verwendung Radlager Satz V4598. Satz funktioniert auch bei Achsschenkeln mit unebenen und begrenzten Flächen
- Deutliche Zeitersparnis zu bisherigen Systemen
- In Verbindung mit Hydraulikzylinder oder manueller Spindel
- Wechseln des Radlagers direkt am Fahrzeug bei minimalem Zeitaufwand
- Kein Ausbau von ABS-Geber, Achsschenkel, Federbein oder Spurstangengelenk
- Radeinstellung oder Bremsanlagen-Entlüftung nicht erforderlich
- Alle Teile sind für die heute auf dem Markt befindlichen Radlagergrößen angepasst
- Montagescheiben haben eine Führung und sind zweiseitig verwendbar
- Montagescheiben mit $\varnothing 62 - 83$ mm und Nabenscheiben $34 - 60$ mm sind enthalten, die Lagerschale ist für Radlager bis 92 mm \varnothing geeignet

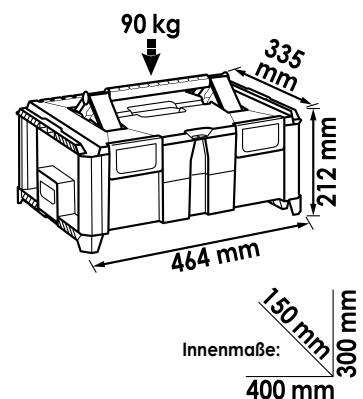
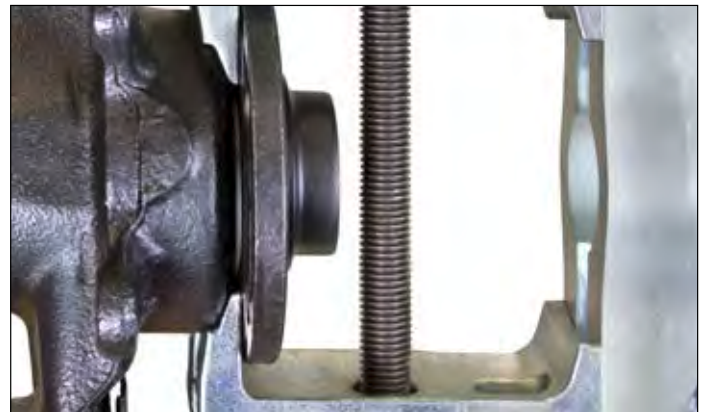
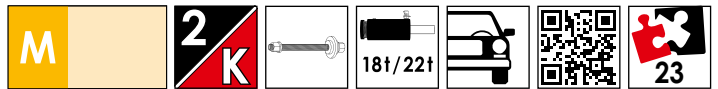

VIGOR No.	Bezeichnung	Ausführung	xx	EAN
V4598	Radlager-, Antriebsachsen und Radnaben Satz · universal		16	045988
V4629	Radnaben Demontage-Werkzeug · universal		7	046299



V5549, EAN 4047728055499

Multibox V4700-L · Kompakt-Radlager / -Nabe Erweiterungs Satz

- In Verbindung mit dem Satz V4680, können alle derzeit bekannten Radlager montiert und demontiert werden
- Erweiterungs Satz aufbauend für z.B. V4680
- Beinhaltet Druckfüße zum Demontieren aller bekannten Radnaben
- Zusätzliche Demontage-Druckfüße für geschraubte Radlagereinheiten (3 und 4 Bolzen) an Vorder- und Hinterachse VAG · OPEL uvm.
- Verstellbarkeit gewährleistet Einsatz aller zur Zeit auf dem Markt erhältlichen geschraubten Radlagereinheiten mit 3 und 4 Bolzen
- z.B. für 4 Bolzen:
 - AUDI A4 · A6
 - VW Passat
 - ŠKODA Octavia
 - SEAT Exeo
- z.B. für 3 Bolzen:
 - VW Golf 6 Cabrio Bj. 2013 → · Golf Bj. → 2012 · Touran Bj. 2015 → · Tiguan Bj. 2016 → · Passat Bj. 2014 →
 - AUDI A3 Bj. 2012 → · TT Bj. 2014 → · Q2 Bj. 2016 →
 - ŠKODA Octavia Bj. 2012 → · Superb Bj. 2015 →
 - SEAT León Bj. 2012 →
 - OPEL Insignia, Astra Bj. 2004 →
 - CHEVROLET/GMC Malibu
 - SAAB 95 Bj. 2010 →
- Verwendung mit Traverse V3871

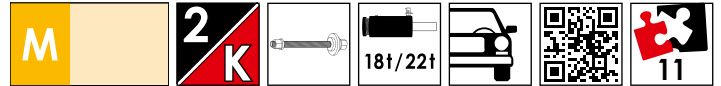

Zweiteiliges Standard-Radlager



3 Bolzen geschraubte Radlagereinheiten



4 Bolzen geschraubte Radlagereinheiten

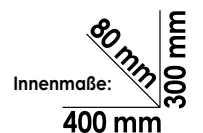
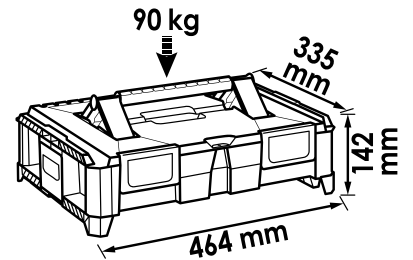

VIGOR No.	Bezeichnung	Ausführung	l mm	XX	EAN 4047728+
V3753	Druckfuß Satz (Demontage) für geschraubte Radlagereinheiten		-	2	037532
V3758	Druckfuß Satz (Demontage) für geschraubte Radlagereinheiten		-	2	037587
V4629-1	Druckfuß Satz für V4629		-	2	046305
V4598-30	Druckrohr Länge 78 mm für V4598 · V4599		78	1	046282
V4614	Nabenscheibe · konisch · Ø 33,8 mm · für V4598		-	1	046145
V4598-2	Nabenscheibe · konisch · Ø 38,8 mm · für V4598		-	1	046152
V4598-3	Nabenscheibe · konisch · Ø 43,8 mm · für V4598 · V4599		-	1	046169
V4598-4	Nabenscheibe · konisch · Ø 59,8 mm · für V4598		-	1	046176



V5549-1N, EAN 4047728075909

Kompakt-Radlager und Radnabe Erweiterungs Satz

- In Verbindung mit dem Satz V4680, können alle derzeit bekannten Radlager montiert und demontiert werden
- Erweiterungs Satz aufbauend für z.B. V4680
- Beinhaltet Druckfüße zum Demontieren aller bekannten Radnaben
- Zusätzliche Demontage-Druckfüße für geschraubte Radlagereinheiten (3 und 4 Bolzen) an Vorder- und Hinterachse VAG · OPEL uvm.
- Verstellbarkeit gewährleistet Einsatz aller zur Zeit auf dem Markt erhältlichen geschraubten Radlagereinheiten mit 3 und 4 Bolzen
- z.B. für 4 Bolzen:
 - AUDI A4 · A6
 - VW Passat
 - ŠKODA Octavia
 - SEAT Exeo
- z.B. für 3 Bolzen:
 - VW Golf 6 Cabrio Bj. 2013 → · Golf Bj. → 2012 · Touran Bj. 2015 → · Tiguan Bj. 2016 → · Passat Bj. 2014 →
 - AUDI A3 Bj. 2012 → · TT Bj. 2014 → · Q2 Bj. 2016 →
 - ŠKODA Octavia Bj. 2012 → · Superb Bj. 2015 →
 - SEAT León Bj. 2012 →
 - OPEL Insignia, Astra Bj. 2004 →
 - CHEVROLET/GMC Malibu
 - SAAB 95 Bj. 2010 →
- Verwendung mit Traverse V3871

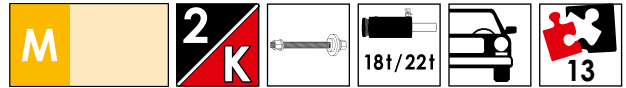

3 Bolzen geschraubte Radlagereinheiten



4 Bolzen geschraubte Radlagereinheiten



4 Bolzen geteilte und verschraubte Radlagereinheit



Geteilte verpresste Radnabe

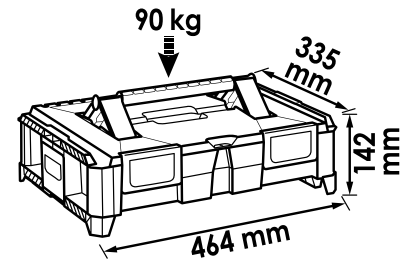

VIGOR No.	Bezeichnung	Ausführung	XX	EAN 4047728+
V5903N	Radlager-Abzieher für geschraubte Radlager		-	075237
V5027	Radnaben-Abzieher		3	050272
V3753	Druckfuß Satz (Demontage) für geschraubte Radlagereinheiten		2	037532
V3758	Druckfuß Satz (Demontage) für geschraubte Radlagereinheiten		2	037587

Innenmaße: 80 mm x 300 mm x 400 mm



V5741N, EAN 4047728**070485**

Längsstreben- und Querlenkerbuchsen Satz · FORD · Volvo · MAZDA

- Inklusive Multibox
- Querlenkerbuchsen Satz, für Hinterachsbuchsen
- Wechseln der Buchse (vordere Längsstrebe im hinteren Bereich) sowie der Hinterachsbuchse
- Für z.B.:
 - FORD Focus · Focus Turnier Bj. 1999 → · C-Max Bj. 2003 → · Kuga Bj. 2008 → · Galaxy Bj. 2006 → 2015 · Mondeo Bj. 2007 → 2015 · S-Max Bj. 2006 → 2014
 - Volvo V50 · S40 · C30 Bj. 2004 → · C70 Bj. 2006 → · S40 Bj. 2002 → 2012 · S60 · S80 Bj. 2010 → · V50 Bj. 2005 → 2012 · V60 Bj. 2010 → · V70 Bj. 2007 → 2015 · XC60 Bj. 2008 → · XC70 Bj. 2002 → 2007
 - MAZDA 3 Bj. 2003 → 2009 · 5 Bj. 2005 → 2010

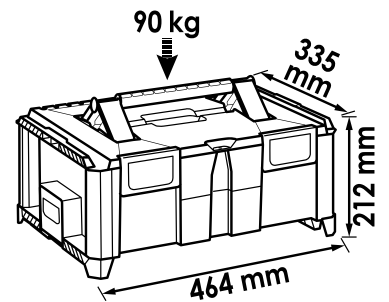

VIGOR No.	Bezeichnung	Ausführung		EAN 4047728+
V3056	Schraube · M 16x40 mm		6	030564
V5902	Hinterachsbuchsen Satz		6	059022
V3649	Buchsen Satz Längsstrebe · FORD · Volvo		4	036498
V3053	Platte mit Gewinde		1	030533

Innenmaße: **150 mm** / **300 mm** / **400 mm**



V4680, EAN 4047728**046800**

Kompakt-Radlager Demontage / Montage Satz

- Inklusive Multibox
- Maximale Belastbarkeit: 22 Tonnen
- Einsatz mit Hydraulikzylinder, mechanischer Spindel oder Werkstattpresse
- An z.B.:
 - VW: Polo · Lupo · Touareg · Fox · T5 vorne und hinten · Crafter
 - AUDI: A2
 - SEAT: Ibiza, Córdoba
 - ŠKODA: Fabia, Rapid, Roomster
 - FORD: Focus, C-Max, Mondeo, S-Max, Kuga
 - LANDROVER: Freelander 2
 - MAZDA: 3 · 5 · 6 · CX-7
 - MERCEDES-BENZ: Sprinter, Vito, Viano
 - MITSUBISHI: Colt
 - SMART: Forfour
 - Volvo: V50 · S40 · V70 · S80 · XC60
 - Weitere Modelle
 - CITROËN: Jumpy (Dispatch), Space Tourer
 - PEUGEOT: Expert, Traveller
 - TOYOTA: ProAce (Verso)

Verstellbarkeit gewährleistet Einsatz an allen zur Zeit auf dem Markt erhältlichen, sowie an zukünftigen Kompakt-Radlager Typen

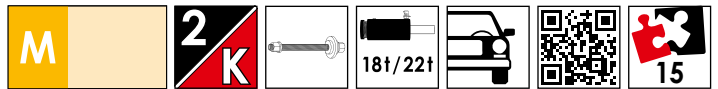

Demontage



Montage

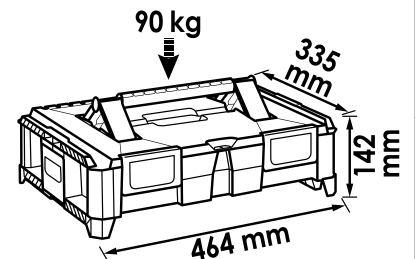

VIGOR No.	Bezeichnung	Ausführung	XX	EAN 4047728+
V2860	Kompakt-Radlager Demontage Satz · universal		7	028608
V2864	Demontagescheibe · konisch · universal		1	028646
V3680	Kompakt-Radlager Montage Satz · universal		13	036801

Innenmaße: 80 mm x 300 mm x 400 mm



V5554, EAN 4047728055543

Kompakt-Radlager Demontage / Montage Satz mit Hydraulik-Fußpumpe

- Inklusive Multibox
- V4680 Universal Werkzeug Satz zur Kompakt-Radlager Demontage und Montage
 - Einsatz an allen zur Zeit auf dem Markt erhältlichen Kompakt-Radlagern
 - Einfacher Verstell-Mechanismus ermöglicht Arbeiten mit Lagern der $\varnothing 62 - 96$ mm
- V2854 Druck- und Zug-Hydraulikzylinder 22 Tonnen
 - Druckfunktion – Benutzung verstärkt kurzzeitig die Kraft bei Verwendung des Schlagkörpers. Anwendung, z.B. bei korrodierten Antriebswellen oder bei Arbeiten mit dem Pressstativ
 - Automatische Kolbenrücklauf-Funktion
- V2847 Hydraulische Fußpumpe
 - Für alle VIGOR Hydraulikzylinder
 - Antriebsdruck: 700 bar
 - Schlauchlänge: 2,2 m
 - Öl-Fassungsvermögen: 0,75 l
 - Pumpe beinhaltet eine CEJN Schnellkupplung
 - Satz in Weichschaum-Einlage, mit Multibox L

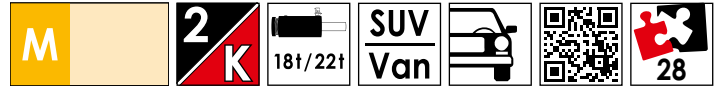

Universal Satz zur Demontage und Montage aller Kompakt-Radlager

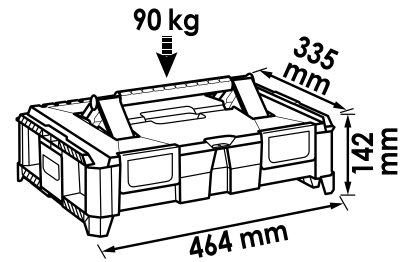
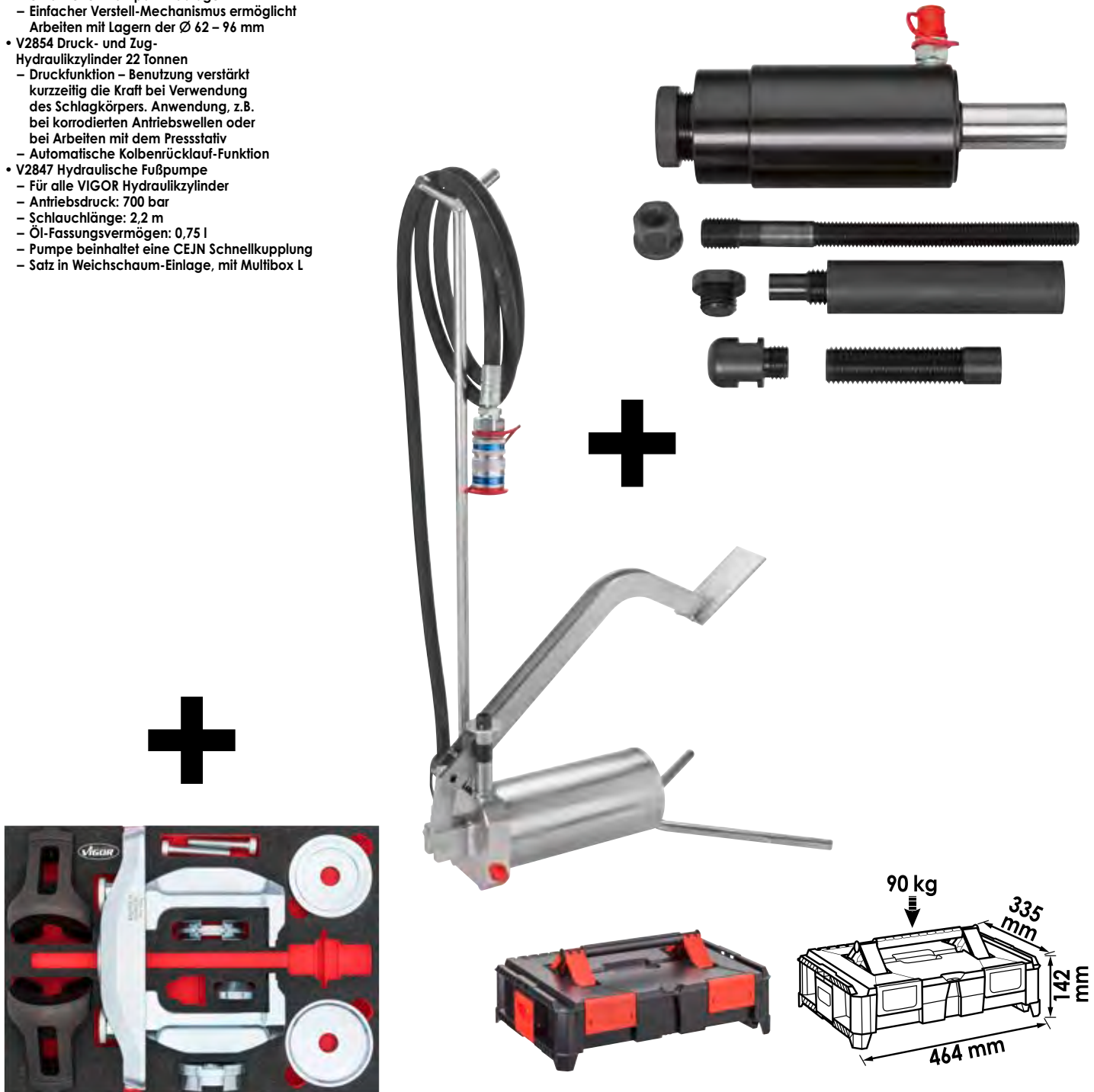

VIGOR No.	Bezeichnung	Ausführung	mm	XX	EAN 4047728+
V4680	Kompakt-Radlager Demontage / Montage Satz		-	15	046800
V2854	Druck- und Zug-Hydraulikzylinder 22 Tonnen		202	10	028547
V2847	Hydraulische Fußpumpe		-	3	028479

Innenmaße:



V5554-2, EAN 4047728069021

Kompakt-Radlager Demontage / Montage Satz mit Pneumatik-Fußpumpe

- Inklusive Multibox
- V4680 Universal Werkzeug Satz zur Kompakt-Radlager Demontage und Montage
 - Einsatz an allen zur Zeit auf dem Markt erhältlichen Kompakt-Radlagern
 - Einfacher Verstell-Mechanismus ermöglicht Arbeiten mit Lagern der $\varnothing 62 - 96$ mm
- V2854 Druck- und Zug-Hydraulikzylinder 22 t
 - Druckfunktion-Benutzung verstärkt die Kraft bei Verwendung des Schlagkörpers kurzzeitig um ein Vielfaches
 - Anwendung, z.B. bei korrodierten Antriebswellen oder bei Arbeiten mit dem Pressstativ
 - Automatische Kolbenrücklauf-Funktion
- V2846 Hydraulikpumpe, pneumatisch
 - Für alle Hydraulikzylinder
 - Ausführung inklusive Manometer



Universal Satz zur Demontage und Montage aller Kompakt-Radlager

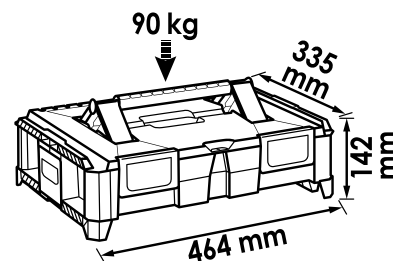

VIGOR No.	Bezeichnung	Ausführung	mm	XX	EAN 4047728+
V4680	Kompakt-Radlager Demontage / Montage Satz		-	15	046800
V2854	Druck- und Zug-Hydraulikzylinder 22 Tonnen		202	10	028547
V2846	Hydraulikpumpe · pneumatisch		-	3	028462

Innenmaße:
80 mm
300 mm
400 mm



V7857, EAN 4047728078924

Traggelenk-Hülsen

- Inklusive Multibox
- Umfangreiche Zusammenstellung für zahlreiche Gelenke der VAG · BMW und MERCEDES-BENZ Achsen
- Umfangreicher Satz von Traggelenk-Hülsen für die gängigsten Modelle
- Verwendung mit Press-Stativ V2885 und 14 t Druck-Hydraulikzylinder V2869
- Effektives und komfortables Arbeiten dank kompakter Bauform des Zylinders
- Vorteile des Kugelgelenk-Ausdrücker V5916-XL: 8,8 t Druckkraft
- Auspressen von Kugelgelenkzapfen und Stabilisatoren
- Auspressen von Lenk- und Bremshebeln bei Nkw und Bussen



Multiboxen

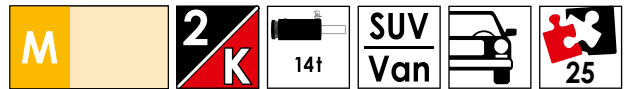
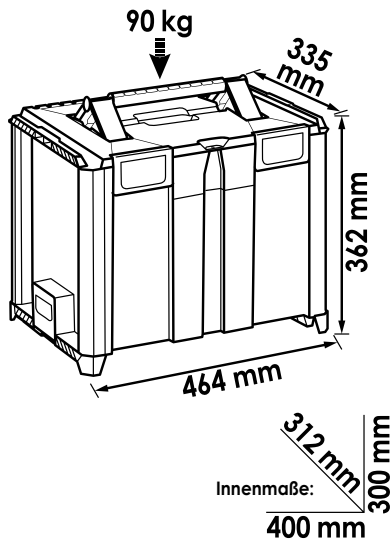

NEU

VIGOR No.	Bezeichnung	Ausführung	mm	XX	EAN 4047728+
V5916-XL	Kugelgelenk-Ausdrücker · hydraulisch 8,8 Tonnen		-	3	066471
V3129	Druckstück · verstellbar M 24		132	1	031295
V2869	Druck-Hydraulikzylinder 14 Tonnen		138	3	028691
V2903	Druckstück für Traggelenk-Werkzeug		-	-	029032
V2897	Druckstück für Traggelenk-Werkzeug		-	-	028974
V2898	Druckstück für Traggelenk-Werkzeug NISSAN Interstar · OPEL Movano · RENAULT Master · HYUNDAI Trajet · Santa Fé		-	-	028981
V2899	Druckstück für Traggelenk-Werkzeug NISSAN Interstar · OPEL Movano · RENAULT Master		-	-	028998
V2895	Druckstück für Traggelenk-Werkzeug		-	-	028950
V2894	Druckstück Traggelenk-Werkzeug (Ausbau)		-	-	028943
V2893	Druckstück für Traggelenk-Werkzeug		-	-	028936
V2900	Druckstück für Traggelenk-Werkzeug VW LT 35		-	-	029001
V2901	Druckstück für Traggelenk-Werkzeug		-	-	029018
V2885	Press-Stativ mit offener Platte mit Adapter um Platte zu schließen		-	9	028851
V4700-XXL	Multibox-XXL · leer		-	-	049276

V7857-L, EAN 4047728078573
Weichschaum-Einlage · leer



V5169, EAN 4047728051699

Zug und Druckhülsen Satz

- Inklusive Multibox
- Inklusive 24 Press-Stücke unterschiedlicher Größen
- Hülsen mit kurzen Größenabständen sind wendbar
- Adapter und Druckwelle ermöglichen Einsatz des Press-Bügels V2885 – praktisch beim Aus- und Einbau von Buchsen und Tragelenken ohne Löcher
- Größere Hülsen u.a. für BMW E 38 / E 39 und MERCEDES-BENZ E- /S-Klasse
- Fester Hülsensitz im Schaumstoff ermöglicht Wandmontage des Satz
- Multibox V4700-L
- Außenmaß: 464x335x142 mm
- Innenmaß: 400x300x80 mm

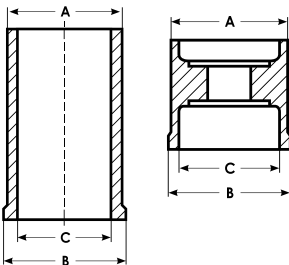

VIGOR No.	Bezeichnung	Ausführung	Ø A mm	Ø B mm	Ø C mm	EAN 4047728+
V2947	Presshülse		40.7	42.5	35.2	029476
V2948	Presshülse		43.7	45.5	38.2	029483
V2949	Presshülse		46.7	48.5	41.2	029490
V2950	Presshülse		49.7	51.5	44.2	029506
V2961	Presshülse		52.7	54.5	47.2	029612
V2962	Presshülse		55.7	57.5	50.2	029629
V2963	Presshülse		58.7	60.5	53.2	029636
V2964	Presshülse		61.7	63.5	56.2	029643
V2965	Presshülse		65.7	67.5	60.2	029650
V2966	Presshülse		69.7	71.5	64.2	029667
V2967	Pressrohr		38.7	44.7	30.5	029674
V2968	Pressrohr		41.7	44.7	34.0	029681
V2969	Pressrohr		44.7	44.7	37.2	029698
V2971	Pressrohr		47.7	55.0	40.2	029711
V2972	Pressrohr		50.7	55.0	43.2	029728
V2973	Pressrohr		53.7	55.0	46.2	029735
V2974	Pressrohr		56.7	55.0	49.2	029742





VIGOR No.	Bezeichnung	Ausführung	Ø A mm	Ø B mm	Ø C mm	EAN 4047728+
V2975	Pressrohr		59,7	70,0	52,2	029759
V2976	Pressrohr		62,7	70,0	55,2	029766
V2977	Pressrohr		65,7	70,0	58,2	029773
V2978	Pressrohr		68,8	70,0	61,2	029780
V2979	Pressrohr		71,7	70,0	64,2	029797
V2980	Pressrohr		75,7	75,7	68,2	029803
V2981	Pressrohr		79,7	79,7	72,2	029810
V2946	Druckstange · verstellbar · 90 mm für V2868		-	-	-	029469
V2945	Adapterplatte für V2868		-	-	-	029452

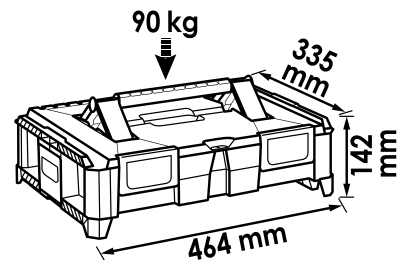

Innenmaße: 80 mm x 300 mm x 400 mm



V5169-A, EAN 4047728075381 Druckhülsen-Erweiterungssatz

- Ausbau und Einbau von Lagern, Buchsen und Kugelgelenken
- Zur Erweiterung von Druckhülsen Satz V5169



VIGOR No.	Bezeichnung	Ausführung	EAN 4047728+
V5169-A45	Adapter Presshülsen · 45 mm		075398
V5169-A55	Adapter Presshülsen · 55 mm		075404
V5169-A70	Adapter Presshülsen · 70 mm		075411
V5169-A76	Adapter Presshülsen · 76 mm		075428
V5169-A80	Adapter Presshülsen · 80 mm		075435



V5168, EAN 4047728051682

Antriebswellen- Auspressvorrichtung Satz

- Inklusive Multibox
- Auspressen von verrosteten und geklebten Antriebswellen direkt am Fahrzeug
- Arbeitsdauer nur circa 5 Minuten
- Für alle Pkw mit 4- und 5-Loch-Nabe durch ovale Löcher für Radschrauben
- Vermeidet Erwärmung, Beschädigung der Antriebswelle oder Schäden an anderen Teilen
- Anwendung: Nabe mit Radschrauben des Fahrzeugs verschrauben, Antriebswelle mit 18 Tonnen oder 22 Tonnen Hydraulikzylinder auspressen (Montage des Schlagkörpers ermöglicht zusätzliches Kraftaufbringen über Einsatz eines Hammers), Herausziehen der Radnabe mit Schlaghammer V2922 und Adapter V2872

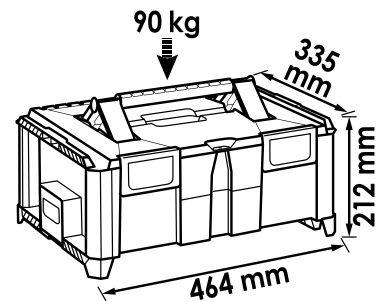
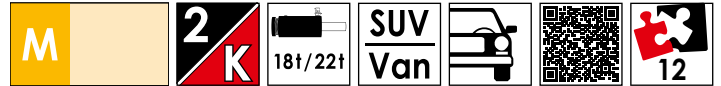

Innenmaße:
150 mm
300 mm
400 mm

VIGOR No.	Bezeichnung	Ausführung	L mm	XX	EAN 4047728+
V2849	Antriebswellen-Auspressvorrichtung · 4- und 5-Loch		-	2	028493
V2854	Druck- und Zug-Hydraulikzylinder 22 Tonnen		202	10	028547



V7154-4, EAN 4047728071765

Bremsscheiben Auspress Satz

- Inklusive Multibox
- Trennen von stark verrosteten und auf der Radnabe festsitzenden Bremsscheiben
- Starkes Hämmern auf die Bremsscheibe kann zur Radlagerbeschädigung führen
- Übertragung von gleichmäßigem Druck über die Auspress-Füße auf die Bremsscheibe. Hydraulik-Zylinder stützt sich mittels Adapterstück an Antriebswellen-Verschraubung ab
- Deutliche Minimierung des Beschädigungsrisikos durch gleichmäßige Kraftübertragung der vier Füße an die Bremsscheibe
- Empfehlung: Verwendung eines Hydraulik-Zylinders, z.B. V4551 oder V2854
- Alternative Anwendung mit V4699
- Spannweite: 260 – 330 mm
- Maximale Belastbarkeit: 22 t

M

2
K

18t/22t

SUV
Van

21

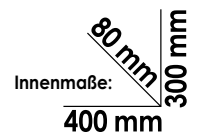
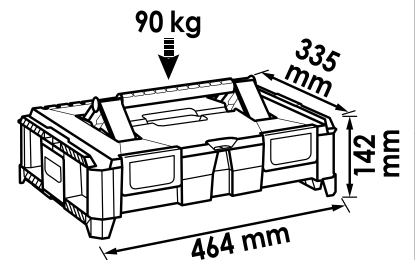

VIGOR No.	Bezeichnung	Ausführung		EAN 4047728+
V3871	Traverse für diverse Druckfüße		1	038713
V5904-4	Schraube · M 14 × 2 – 45 · Innensechskant		2	059145
V7154-1	Auspress Fuß · einzeln		-	071550
V7154-2	Fixierplatte · einzeln		-	071567
V5904-3	Gleiteller		4	059138



V7133, EAN 4047728071338

Kompakt-Radlager Demontage / Montage Satz

- Inklusive Multibox
- Befähigung aller Kompakt-Radlager von Smart bis Sprinter
- Verwendete Montageeinheit V4491 gewährleistet fachmännische Montage des Kompakt-Radlagers der zweiten Generation
- Inhalt: Spezialeinheit zur Montage des geschlossenen Radlagers sowie Universal Satz für alle weiteren Kompakt-Radlager Durchmesser
- Kosten- und Zeitersparnis durch Entfallen des Verbauens eines neuen Achsschenkels, der anschließenden Achsvermessung sowie dem damit verbundenen Mehraufwand
- Inklusive zwei Multiboxen V4700-L

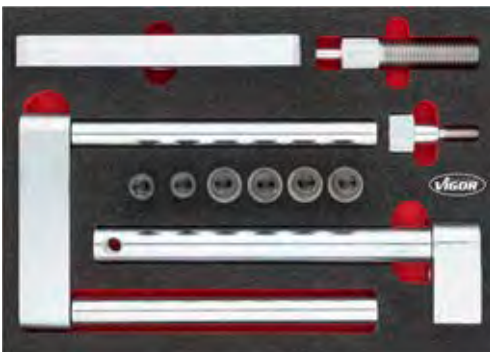
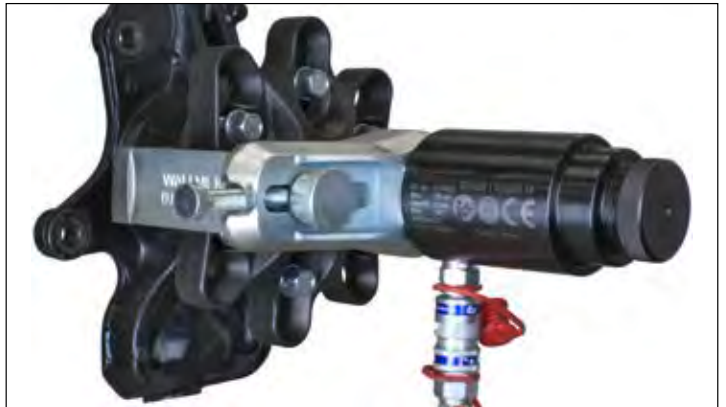

2 x

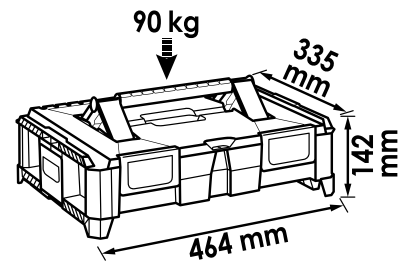

VIGOR No.	Bezeichnung	Ausführung		EAN
V7133N	Kompakt-Radlager Montage-Erweiterungssatz		14	071703
V4680	Kompakt-Radlager Demontage / Montage Satz		15	046800
V5027	Radnaben-Abzieher		3	050272
V5905	Radnaben- / Radlager-Abzieher · für 6 und 8 Bolzen		3	059152

Innenmaße:



V7133N, EAN 4047728071703

Kompakt-Radlager Montage-Erweiterungssatz

- Betätigung von Kompakt-Radlagern an Sprinter · Vito · Viano · Crafter
- Hinweis: Verwendung herkömmlicher Werkzeug Sätze ist nicht möglich, da geschlossenes Radlager verbaut ist. Antrieb mit Spindelsystem ist nicht durchführbar
- Spezieller Satz zur Montage des an der Radnabe geschlossenen Radlagers u.a. für folgende Fahrzeuge:
 - MERCEDES-BENZ V-Klasse Bj. 2014 → · Viano Bj. 2003 → · Vito Kasten Bj. 2014 → · Sprinter Bj. 2008 →
 - VOLKSWAGEN Crafter Bj. 2011 →
- Kosten- und Zeitersparnis durch Entfallen des Verbauens eines neuen Achsschenkels, der anschließenden Achsvermessung sowie dem damit verbundenen Mehraufwand
- Voraussetzung: Montageeinheit für Kompakt-Radlager V4491 sowie einer Antriebseinheit z.B. Hydraulik-Zylinder V4551 oder V2854
- Inklusive Multibox

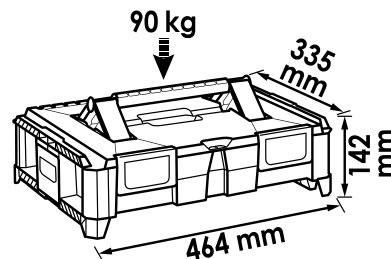
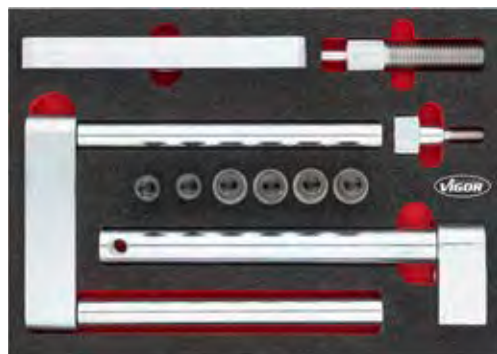

VIGOR No.	Bezeichnung	Ausführung	L mm	XX	EAN 4047728+
V7133-2	Einpress-Gewinde mit Führung M24 · L 110 mm		110	1	071451
V7133-3	Einpress-Traverse CC = 160–186 mm · L 226 mm		-	1	071468
V7133-4	Einpress-Befestigung L 266 mm · M14 · M16		-	1	071475
V7133-5	Fixierschraube M14 konisch		-	1	071482
V7133-6	Einpress-Holme L 242 mm · 2x M14		-	6	071499
V7133-7	Einpress-Platte CC = 135–145 mm		-	1	071505
V7133-8	Befestigung Achsschenkel M14		-	1	071512
V7133-9	Gewindehülse 28x14,5x3 mm		-	1	071529
V7133-10	Gewindehülse M14x45 10,9		-	-	071536
V3056	Schraube · M 16x40 mm		-	6	030564

Innenmaße:
80 mm
300 mm
400 mm



V2849, EAN 4047728**028493**

Antriebswellen-Auspressvorrichtung · 4- und 5-Loch

- Auspressen von verrosteten oder geklebten Antriebswellen direkt am Fahrzeug
- Für Pkw mit T4- und 5-Loch-Nabe durch ovale Löcher für Radschrauben
- Vermeidet Erwärmung, Beschädigung der Antriebswelle oder Schäden an anderen Teilen
- Anwendung:
 - Nabe mit Radschrauben des Fahrzeugs verschrauben
 - Antriebswelle mit 18 Tonnen oder 22 Tonnen Hydraulikzylinder auspressen. (Montage des Schlagkörpers ermöglicht zusätzliches Kraftaufbringen über Einsatz eines Hammers)
 - Herausziehen der Radnabe mit Schlagauszieher V2922 und Adapter V2872



Innengewinde 1.1/2"



**Arbeitsdauer nur
ca. 5 Minuten**

VIGOR No.	Bezeichnung	Ausführung	EAN 4047728+
V3147	Antriebswelle 4-Loch · Lochkreis 92 – 120 mm		031479
V3148	Antriebswelle 5-Loch · Lochkreis 98 – 131 mm		031486



V2922, EAN 4047728029223

Schlaghammer 5,2 kg

- Demontage Radnabe und Bremsscheibe
- Verwendung mit Radnaben Satz V2871 oder Adapter V2872 für Antriebswellen-Werkzeug V2849
- Ergonomischer Gleithammer



Innengewinde: M 18



V2872, EAN 4047728028721

Adapter für Schlaghammer V2922

- Adapter zur Verwendung mit Schlaghammer (V2922) und Antriebswellen-Werkzeug (V2849) für Ausbau von Radnaben

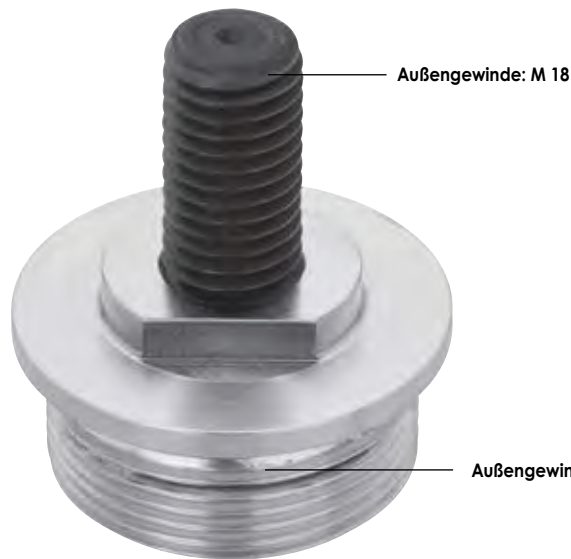

Außengewinde: M 18

Außengewinde: 1.1/2"



V2871, EAN 4047728028714

Radnaben Demontage Satz für V2922

- Radnaben Demontage mit Schlagwerkzeug V2922



VIGOR No.	Bezeichnung	Ausführung	L mm	EAN 4047728+
V3140	Zugstange M 18		150	031400
V3126	Kragenmutter · M 18x2,5		-	031264
V3036	Nabenscheibe Ø 52 mm · Innenloch-Ø 20,25 mm · passend für Spindel M 20		-	030366
V3035	Nabenscheibe Ø 45 mm · Innenloch-Ø 20,25 mm · passend für Spindel M 20		-	030359
V4598-2	Nabenscheibe · konisch · Ø 38,8 mm · für V4598		-	046152
V3033	Nabenscheibe Ø 32 mm · Innenloch-Ø 20,25 mm · passend für Spindel M 20		-	030335



V5916, EAN 4047728059817

Kugelgelenk-Ausdrücker · hydraulisch 4,5 Tonnen

- Hydraulisches Ausdrücken der Kugelgelenkzapfen an Spurstangen sowie Stabilisatoren mit maximaler Druckkraft von 4,5 Tonnen
- Höhenverstellung 60 und 72 mm sowie einstellbarer Durchmesser auf 26 und 32 mm
- Bauform optimiert Zugang zu schwer zugänglichen Stellen
- Werkzeug kann, mit Hilfe des mitgelieferten Distanzrings, in unterschiedliche Hublängen eingestellt werden
- Beidseitige Montage der Druckfüße um ebenfalls in beengten Platzverhältnissen arbeiten zu können
- Mitgelieferter Sicherheitsgurt verhindert das Herunterfallen des Werkzeugs nach dem Einsatz
- Betrieb mit Hydraulikpumpe V2846 und V2847 (700 bar)
- Speziell für moderne Aluminium Achsschenkel, bei denen konisch zulaufende Kegelschrauben verbaut sind

4.5 t

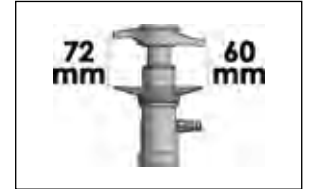

V5916-1, EAN 4047728072953

Kugelgelenk-Ausdrücker Erweiterung Pins

- Ausdrücken von Kugelgelenken sowie Spurstangen-Enden, mit Bolzen statt Mutterverschraubungen an der Kegellachse
- Pressplatten-Erweiterung für Kugelgelenk-Ausdrücker V5916
- Oberplatte kann individuell der Einbausituation angepasst und verstellt werden



V5916-2, EAN 4047728073554

Druckfuß-Erweiterung

- Für Kugelgelenkstifte mit Länge über 72 mm
- Anwendung an z.B. SUV und Nkw von CHEVROLET oder GMC
- Satz bestehend aus Presswerkzeug und Pressstück
- Betätigung mit hydraulischem Kugelgelenk-Ausdrücker V5916
- Auch in beengten Bauräumen einsetzbar



V5916-XL, EAN 4047728066471

8.8 t

Kugelgelenk-Ausdrücker · hydraulisch 8,8 Tonnen

- Hydraulisches Ausdrücken der Kugelgelenkzapfen an Spurstangen sowie Stabilisatoren, oder aber Lenk- und Bremshebel bei Lkw und Bussen, mit maximaler Druckkraft von 8,8 Tonnen
- Höhenverstellung 81 und 113 mm sowie einstellbarer Durchmesser auf 42 und 56 mm
- Bauform optimiert Zugang zu schwer erreichbaren Stellen
- Das Werkzeug kann, mit Hilfe der mitgelieferten Distanzringe, in unterschiedliche Hublängen eingestellt werden
- Beidseitige Montage der Druckfüße, um ebenfalls in beengten Platzverhältnissen arbeiten zu können
- Mitgelieferter Sicherheitsgurt verhindert das Herunterfallen des Werkzeugs nach dem Einsatz
- Betrieb mit Hydraulikpumpe V2846 · V2847 (700 bar)
- Speziell für moderne Aluminium Achsschenkel, bei denen konisch zulaufende Kegelschrauben verbaut sind
- \approx 7,0 kg



V2885, EAN 4047728**028851**

Press-Stativ mit offener Platte mit Adapter um Platte zu schließen

- Wechsel von Trag Gelenken und Hinterachsbuchsen
- Offene Press-Stativ Platte wird durch Adapter-Ring zur geschlossenen Platte
- Innendurchmesser der beiden Streben liegt bei 118 mm



VIGOR No.	Bezeichnung	Ausführung	mm	XX	EAN 4047728+
V3053	Platte mit Gewinde		-	1	030533
V3055	Stützbein		185	2	030557
V3142	Adapterplatte		-	1	031424
V3056	Schraube · M 16x40 mm		-	6	030564
V3057	Platte mit offener Seite		-	-	030571



Tabelle mit Druckstücken für unterschiedliche Pkw

Typ	Druckstück	
BMW E30, E34 (innen)	V2906, V2905, V2904	
BMW E34 (außen)	V2909, V2908, V2907	
MERCEDES-BENZ Typ 124	V2906, V2905, V2902	
MERCEDES-BENZ Sprinter	V2901, V2900	
MERCEDES-BENZ Sprinter 2007 →	V2895, V2894, V2893	
DACIA Logan I (Bj. 2006 → 2013), RENAULT Clio 3 (Bj. 2006 → 2013), RENAULT Grand Scénic I (Bj. 2003 → 2009), RENAULT Laguna 1, RENAULT Mégane 2, RENAULT Modus (Bj. 2005 → 2013), RENAULT Scénic 2	V2906, V2892, V2891	
NISSAN Interstar, OPEL Movano, RENAULT Master	oben:	V2899, V2897
	unten:	V2903, V2899, V2898
VW T4	V2901, V2899	
VW LT35	V2901, V2900	
VW Crafter	V2895, V2894, V2893	
HYUNDAI Trajet, Santa Fé	V2898, V2896, V2892	

Tabelle mit Druckstücken

VIGOR No.	EAN 4047728+
V2891	028912
V2892	028929
V2893	028936
V2894	028943
V2895	028950
V2896	028967
V2897	028974
V2898	028981
V2899	028998
V2900	029001
V2901	029018
V2902	029025
V2903	029032
V2904	029049
V2905	029056
V2906	029063
V2907	029070
V2908	029087
V2909	029094



V3055-275, EAN 4047728**076494**

Stützbein Satz · 275 mm

- Verlängerung ermöglicht zusätzliche Anwendungen zum Pressen von Buchsen und Lagern
- In Verbindung mit Pressstativ V2885



NEU

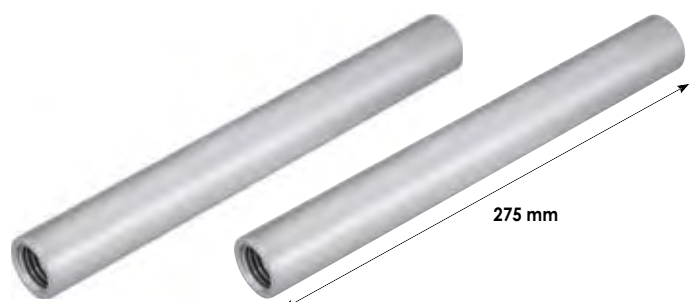

V2912, EAN 4047728029124

**Querlenkerbuchsen Satz · hinten ·
FORD · MAZDA · Volvo**

- Für Hinterachsbuchsen – nur in Verbindung mit V2885 z.B. an:
 - FORD: Focus, Bj. 1999 → · C-Max, Bj. 2003 → · Kuga, Bj. 2008 → 2012
 - MAZDA: 3, Bj. 2003 → · 5, Bj. 2005 → 2001
 - Volvo: V50 · S40 · C30, Bj. 2004 → · C70, Bj. 2006 →

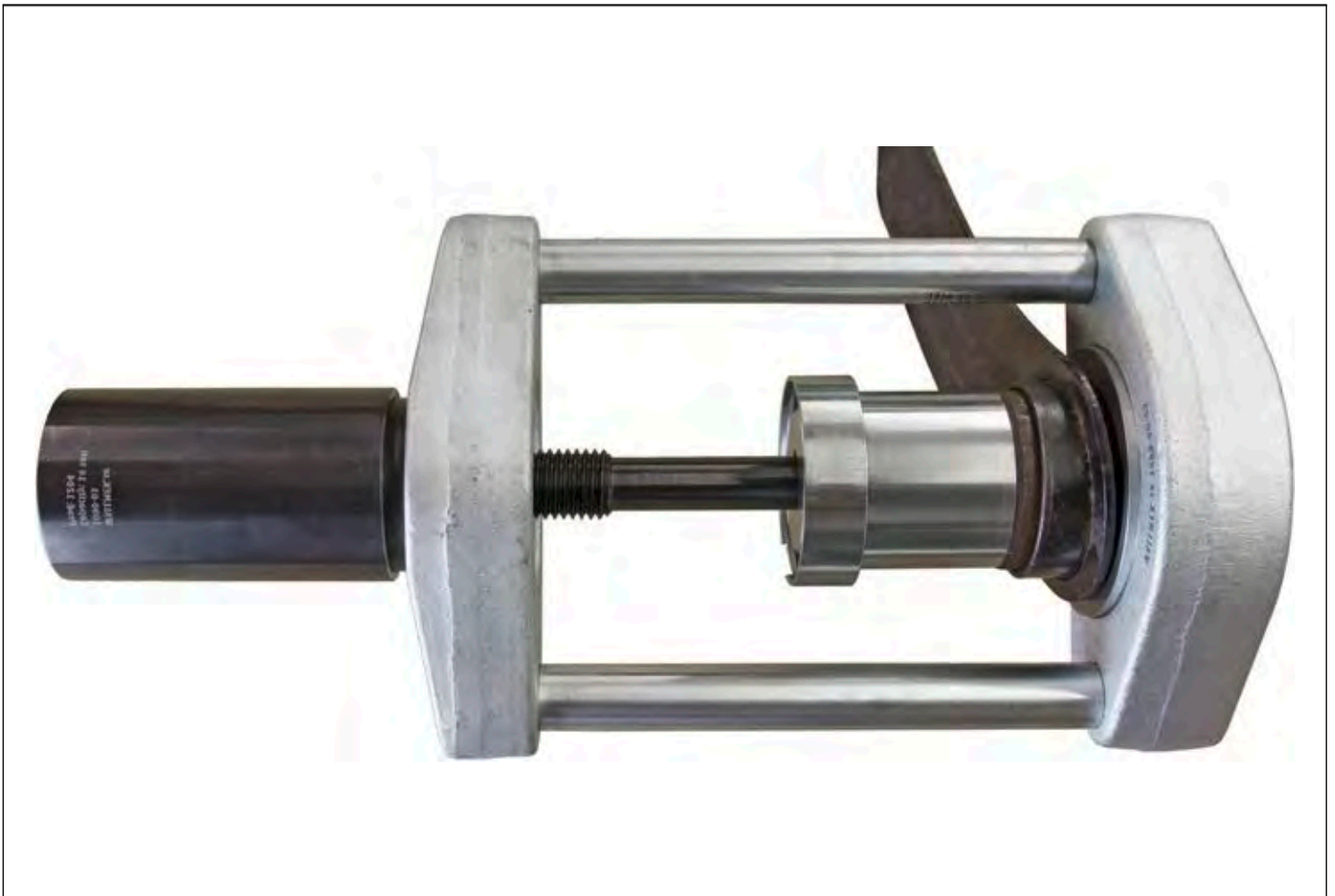

V3649, EAN 4047728036498

Buchsen Satz Längsstrebe · FORD · Volvo

- Austauschen der Buchse der vorderen Längsstrebe im hinteren Bereich
- Buchse und Pressrahmen nicht mehr als 16 Tonnen belasten
- Für z.B.:
 - FORD: Mondeo · Tourneo Bj. 2000 → 2007
 - FORD: Bj. 2007 →: Mondeo, S-Max, Galaxy
 - Volvo: Bj. 2007 →: S60 · S80 · V60 · V70 · XC60 · XC70



Zeitaufwand: 15 Minuten pro Wechsel



VIGOR No.	Bezeichnung	Ausführung	EAN 4047728+
V3650	Pressrahmen		036504
V3403	Druckrohr		034036
V3405	Adapterring		034050
V3404	Druckplatte		034043

Anwendung nur in Verbindung mit V3053 und V3056

V3053, EAN 4047728030533

Platte mit Gewinde

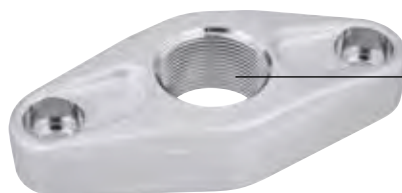

Innengewinde 1.1/2"

V3056, EAN 4047728030564

Schraube · M 16 x 40 mm

- Schraube · M 16 x 40 mm



V2913, EAN 4047728029131

Traggelenk Satz MERCEDES-BENZ

- Traggelenkwechsel
- MERCEDES-BENZ E-Klasse, Typ 211 · 219 · S-Klasse Typ 220 · SL-Klasse Typ 230
- Mit Traggelenk-Demontagehülse V2915 auch für MERCEDES-BENZ ML 163
- Nur einsetzbar in Verbindung mit Pressbügel (V2858N)



VIGOR No.	Bezeichnung	Ausführung	mm	EAN 4047728+
V3047	Druckhülse		-	030472
V3048	Montagehülse		-	030489
V3049	Demontagering		-	030496
V3129	Druckstück · verstellbar M 24		132	031295



V2915, EAN 4047728029155

Traggelenk-Demontagehülse MERCEDES-BENZ

- Für MERCEDES-BENZ ML 163
- Verwendung in Verbindung mit V2913
- Nur einsetzbar in Verbindung mit Pressbügel (V2858N)



V2923, EAN 4047728029230

Traggelenk Satz FORD

- Für FORD Transit
- Arbeiten direkt am Fahrzeug
- Zeitaufwand: 10 Minuten
- Nur einsetzbar in Verbindung mit Pressbügel (V2858N)



VIGOR No.	Bezeichnung	Ausführung	EAN 4047728+
V2999	Druckhülse		029995
V3000	Montage- / Demontagedeckel		030007
V3001	Montagehülse		030014
V3002	Demontagehülse		030021



V2914, EAN 4047728029148

Stabilisator-Kugelgelenk Satz MERCEDES BENZ

- Für MERCEDES-BENZ: E-Klasse, Typ 211 und S-Klasse Typ 220
- Nur Ausbau des Stabilisators – kein Ausbau von Stoßdämpfer oder unteren Lenkerbefestigung erforderlich
- Nur einsetzbar in Verbindung mit Pressbügel (V2858N)



VIGOR No.	Bezeichnung	Ausführung	EAN 4047728+
V3045	Druckhülse		030458
V3046	Druckhülse		030465

V2917, EAN 4047728029179

Lenkerbuchsen Satz · hinten · MERCEDES-BENZ

- Demontage / Montage der hinteren / unteren Buchsen im Längslenker
- Für MERCEDES-BENZ: C-, E-, S-Klasse

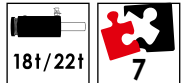

VIGOR No.	Bezeichnung	Ausführung	l mm	XX	EAN 4047728+
V3052	Druckrohr		-	1	030526
V3136	Zugstange · M 14 · maximal 12 t		250	1	031363
V3135	Adapter · M 22x2,5 – M 14x2,0		-	1	031356
V3050	Demontagering		-	1	030502
V3051	Montagehülse		-	1	030519
V3044	Gegenhalterring Einbau		-	1	030441
V3137	Kragenmutter · M 14x2,0		-	2	031370

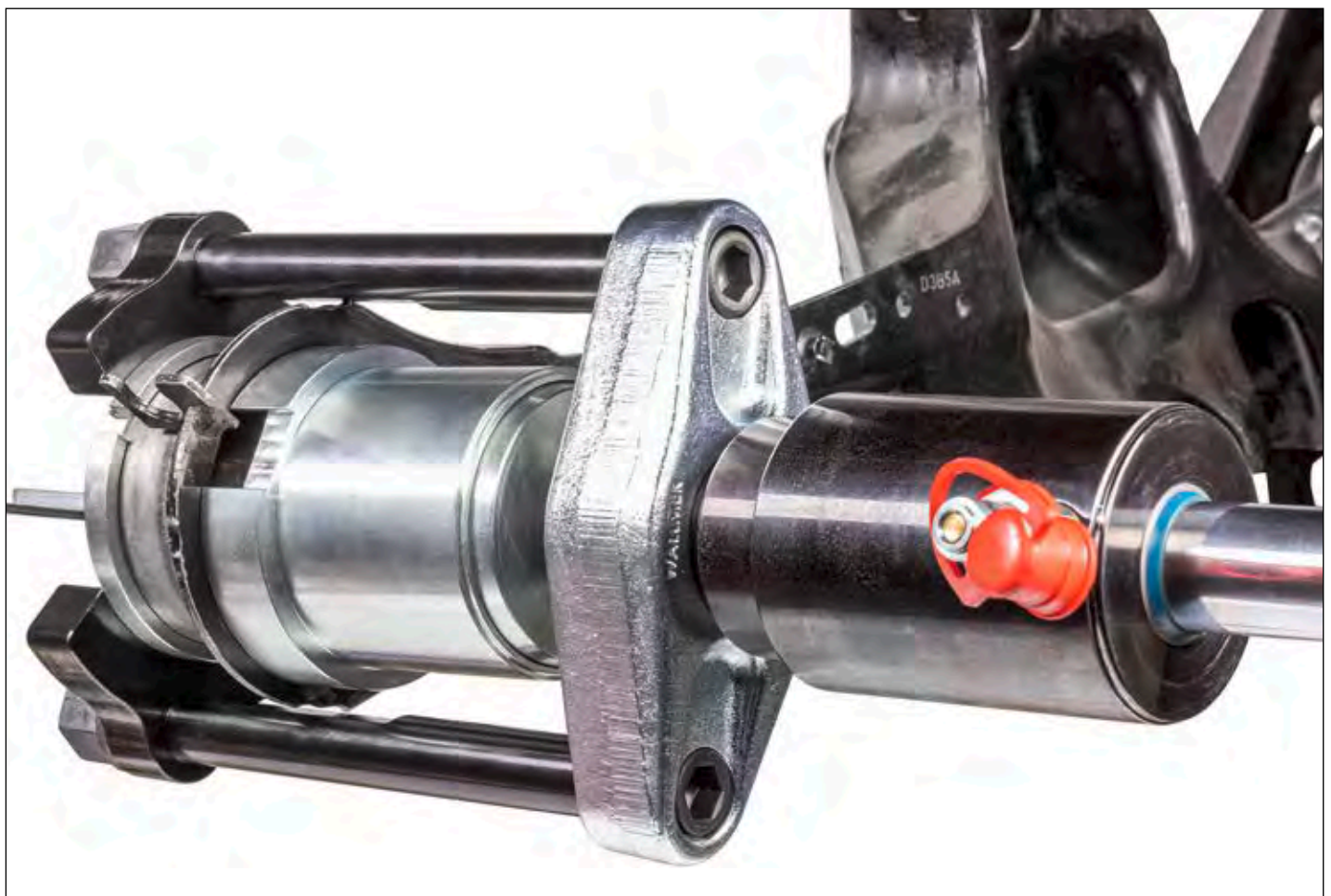

V7865, EAN 4047728**078658**

Silentlager Buchsen Satz · VAG

- Demontage und Montage von Silentlagern an der Hinterachse diverser VAG Modelle
- Mithilfe der speziellen Halbschalen wird eine Passgenauigkeit auf die Buchse gewährleistet
- Für den Wechsel der Buchse an nachfolgenden Fahrzeugen:
 VW Golf 7 Bj. 2017 → · Golf 7 Variant Bj. 2017 → ·
 Golf 7 Sportsvan Bj. 2017 → · Golf 8 Bj. 2019 → ·
 Polo 6 Bj. 2017 → · T-Cross Bj. 2018 → · T-Cross Bj. 2017 →
 AUDI A1 Bj. 2018 → · A3 Bj. 2017 → · Q2 Bj. 2017 →
 SEAT Arona Bj. 2017 → · Ateca Bj. 2016 → ·
 Ibiza Bj. 2017 → · León Bj. 2018 →



NEU



Demontage



Montage



Buchse



VIGOR No.	Bezeichnung	Ausführung	← L → mm	EAN 4047728+
V7866	Silentlager Hülse		-	078665
V7867	Silentlager Hülse		-	078672
V7868	Silentlager Halbschale		-	078689
V7869	Silentlager Hülse		-	078696
V7870	Silentlager Hülse		-	078702
V3220	Zugstange · M 12 · maximal 9 t		250	032209
V3219	Adapter · M 22x2,5 – M 12x1,75		-	032193
V3208	Kragenmutter · M 12x1,75		-	032087





V4476N, EAN 4047728068000

Hydraulischer Federspanner mit 10 Federteller

- Universal einsetzbar für fast alle Feder- und Stoßdämpferbeine im Bereich Pkw sowie leichten Transportern
- Auch für MERCEDES-BENZ C-Klasse (W203), neuere BMW- sowie VAG-Federbeine, bei denen eine elektronische Dämpfer-Verstellung verbaut ist (EDC, DCC)
- Durch das Greifen der Federn innerhalb der Federwindungen sind gegebenenfalls störende Bauteile am Stoßdämpfer irrelevant und haben keinen Einfluss auf die Funktionsweise des Federspanners
- Einsetzbar sowohl für links- als auch rechtsgewinkelte Federn
- Präzise Ausrichtung der Feder- und Stoßdämpferbeine
- Auch zur Trennung von Achsschenkeln und Federbeinen durch Entlastung des Federbeines direkt am Fahrzeug ohne Demontage der Achswelle, gegebenenfalls vorgeschriebene Achsvermessung entfällt
- Dreibein inklusive Rollen ermöglicht Verstauen und mobiles Arbeiten mit dem Federspanner – kein Platz auf einer Werkbank benötigt
- Umgekehrtes Aufsetzen des Stützrahmens ermöglicht Einsatz des Federspanners als zusätzliche hydraulische Stütze und kann mit 2,1 Tonnen Kraft verwendet werden, z.B. für Arbeiten an Lenkern oder Traggelenken
- Verwendung eines „Quick-Pin“ Mechanismus zum einfachen und schnellen Umbauen des Federspanners zur Nutzung der drei Funktionen: Greifen der Feder, Trennung von Achsschenkeln und Federbeinen sowie Einsatz als hydraulische Stütze
- Stabiler Dreibein-Fuß inklusive Arretierung und Positionierung für einen rutschfesten und waagerechten Stand
- Beim Spannen von alten Federn, bei denen ein Bruch wahrscheinlich ist, dient der robuste Sicherheitsriemen als zusätzlicher Sicherheitsaspekt
- Inklusive aller Federteller (4x V4352, 4x V4353 · 2x V4354)
- Hydraulikpumpe mit 700 bar Betriebsdruck wird zum Betätigen benötigt (V2846 / V2847)
- Gewicht: 44 kg
- Kapazität: 2,1 Tonnen
- Hub: 430 mm
- Federteller Ø 70 – 160 mm





V4476-1, EAN 4047728060264

Adapter-Ring OPEL Insignia

- Zur Verwendung mit VIGOR Federspanner V4476
- Zusätzlicher Adapterring wird benötigt bei Arbeiten für Federbeine folgender Fahrzeuge:
- OPEL Insignia B Bj. 2017 → 2019
 - Limousine Grand Sport
 - Kombi Sports Tourer



V4352, EAN 4047728043526

Federteller Ø 70 – 160 mm

- Federteller einzeln (es werden vier Federteller benötigt)
- Nur verwendbar mit Federspanner V4307



V4353, EAN 4047728043533

Federteller Ø 150 – 240 mm

- Federteller einzeln (es werden vier Federteller benötigt)
- Nur verwendbar mit Federspanner V4307
- 4 Federteller im Federspanner Satz V4307 enthalten



V4354, EAN 4047728043540

Federteller Ø 150 – 240 mm mit Arretierung

- Federteller einzeln (es werden vier Federteller benötigt)
- Nur verwendbar mit Federspanner V4307
- Speziell für CHRYSLER Voyager



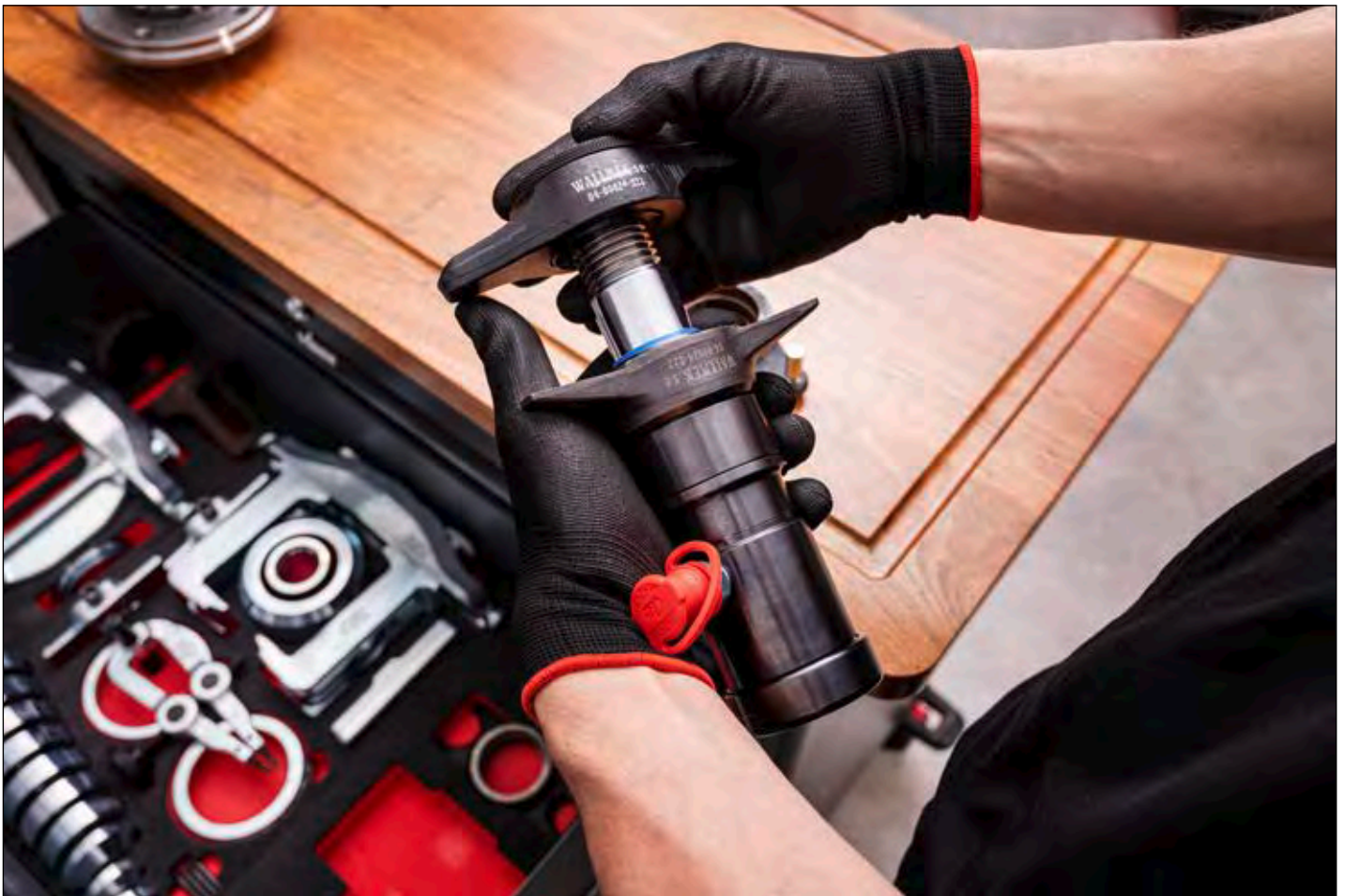

Mobile Werkbänke mit Spezialwerkzeug Sortiment



V7026, EAN 4047728070263



Mobile Werkbank mit Spezialwerkzeug Sortiment

• Lieferung ohne Fahrgriff



51

V4814

+ Sortiment

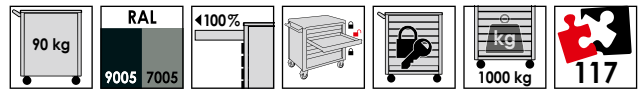

V7026-1, EAN 4047728070386

VIGOR SERIES XL

Mobile Werkbank mit Spezialwerkzeug Sortiment

• Lieferung ohne Fahrgriff

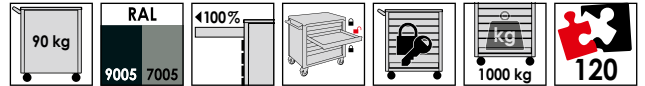

51

V4814

+ Sortiment

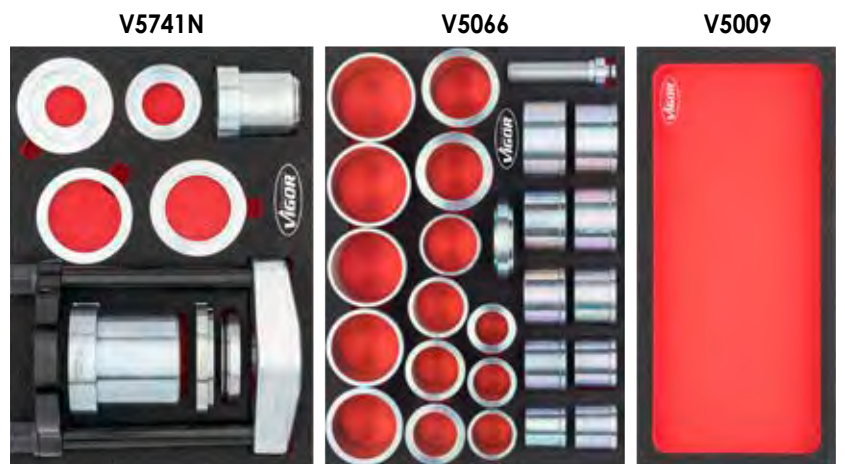
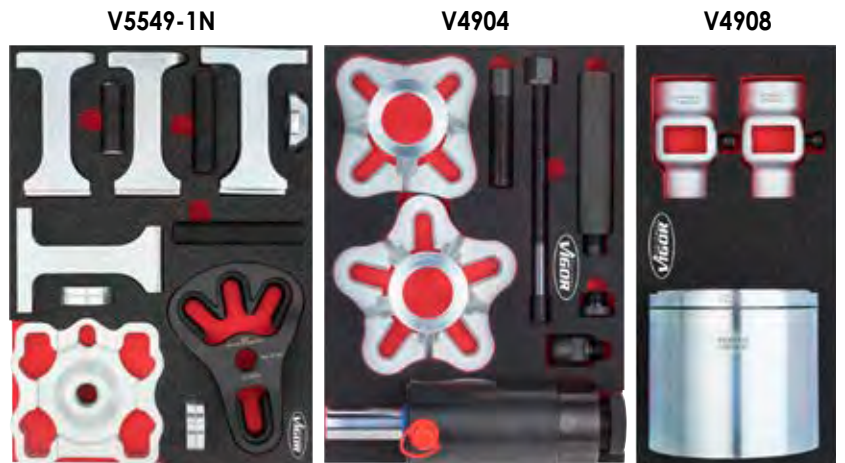

Mobile Werkbänke mit Spezialwerkzeug Sortiment



V7026-2, EAN 4047728070478



Mobile Werkbank mit Spezialwerkzeug Sortiment

• Lieferung ohne Fahrgriff

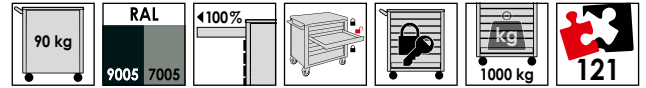

51
V4814

+ Sortiment

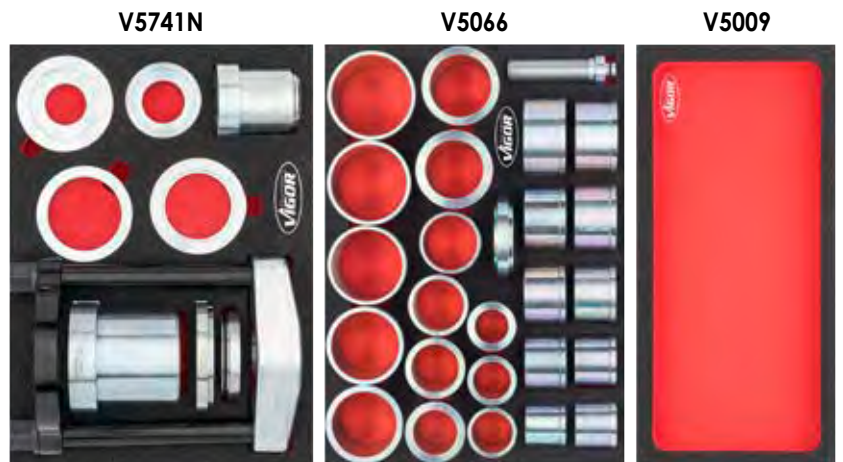
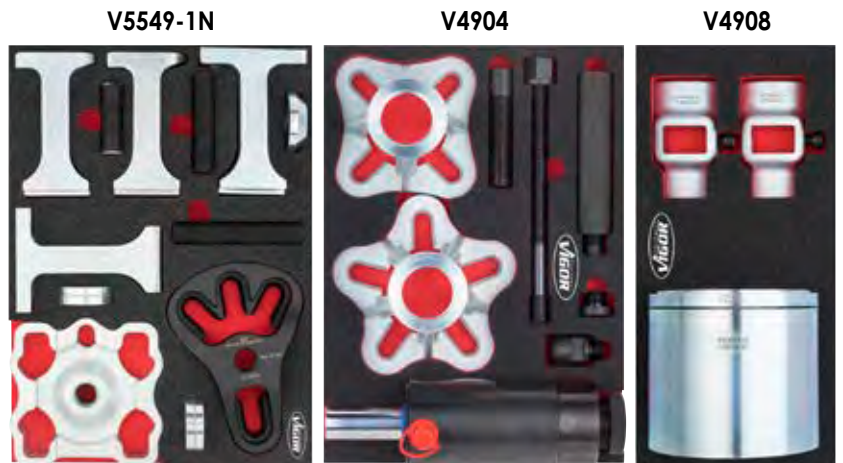

V7030, EAN 4047728077309

VIGOR
SERIES **XL**

Mobile Werkbank mit Spezialwerkzeug Sortiment

• Lieferung ohne Fahrgriff

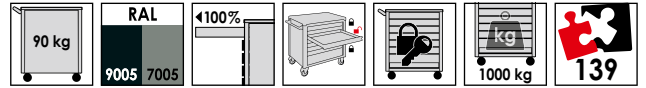

51

V4814

+ Sortiment

V7201



V4906N



V7724



V5549-1N



V4904



V7723



V5741N



V5066



V7722



Mobile Werkbänke mit Spezialwerkzeug Sortiment



V7030-2, EAN 4047728077323



Mobile Werkbank mit Spezialwerkzeug Sortiment

• Lieferung ohne Fahrgriff

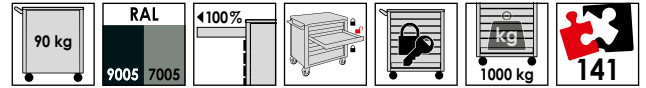

51
V4814

+ Sortiment

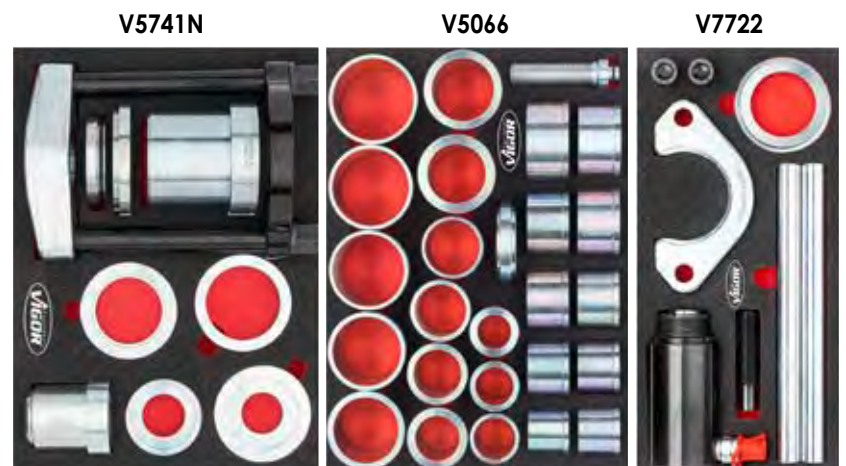
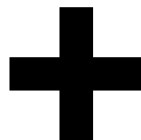

V7276, EAN 4047728072762

VIGOR
SERIES **XL**

Mobile Werkbank mit Spezialwerkzeug Sortiment

• Lieferung ohne Fahrgriff

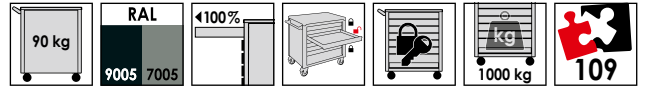

51

V4814

+ Sortiment

V7201



V7133N



V5058



V7261

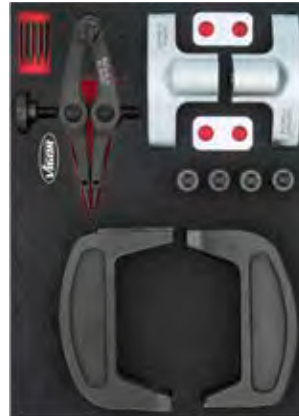

V7265



V7267



V7270



V7273



V7263



Mobile Werkbänke mit Spezialwerkzeug Sortiment



V7276-2, EAN 4047728072908



Mobile Werkbank mit Spezialwerkzeug Sortiment

• Lieferung ohne Fahrgriff

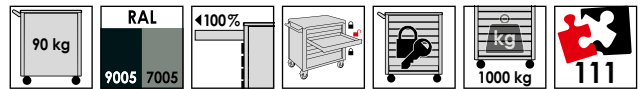

51

V4814

+ Sortiment

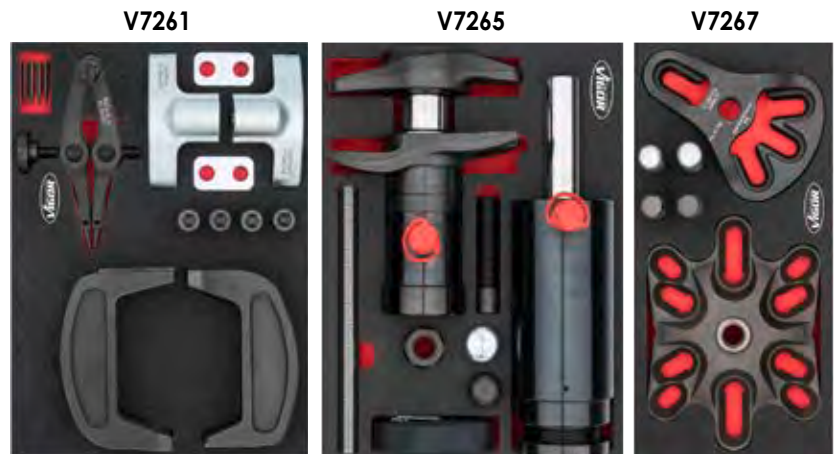
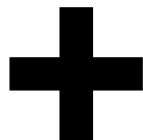

Erklärung der Piktogramme

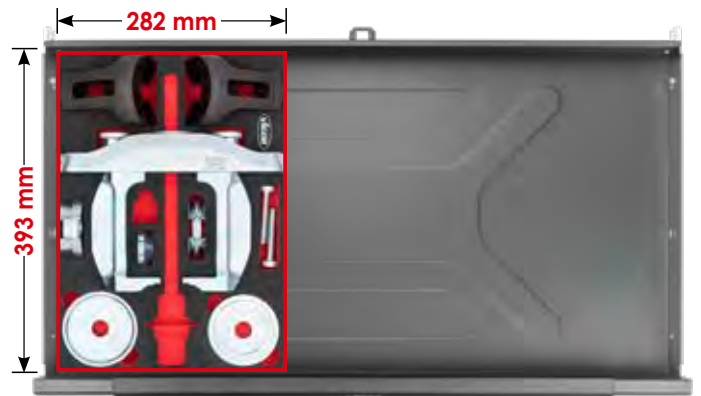

V5064, EAN 4047728050647
Druck- und Zug-Hydraulikzylinder 18 Tonnen



V5058-L, EAN 4047728050579
Weichschaum-Einlage · leer



V5058, EAN 4047728050586
Druck- und Zug-Hydraulikzylinder 22 Tonnen



V5085-L, EAN 4047728050869
Weichschaum-Einlage · leer



Spezial Weichschaum-Einlagen



V4908, EAN 4047728**049085**
Lager-Nabenschalen Satz mit
Radlager-Fixierung



V4908-L, EAN 4047728**049078**
Weichschaum-Einlage · leer



V4915, EAN 4047728**049153**
Druckfuß Satz

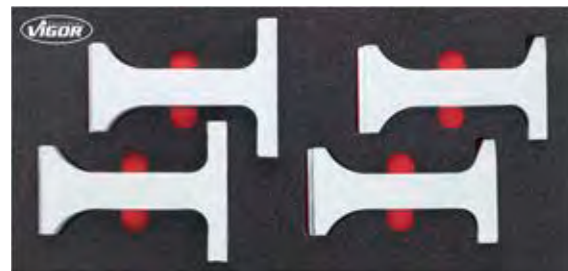

V4915-L, EAN 4047728**049146**
Weichschaum-Einlage · leer



V5062, EAN 4047728**050623**
Antriebswellen-Werkzeug Satz



V5062-L, EAN 4047728**050616**
Weichschaum-Einlage · leer



V4921, EAN 4047728**049214**
Lagerinnenring-Abzieher mit
Sicherungsring-Werkzeug



V4921-L, EAN 4047728**049207**
Weichschaum-Einlage · leer



V7263, EAN 4047728**072649**

Radlager Satz · vorne · IVECO Daily 2014

• Austausch des vorderen Radlagers bei IVECO Daily Modellen Bj. 2014→

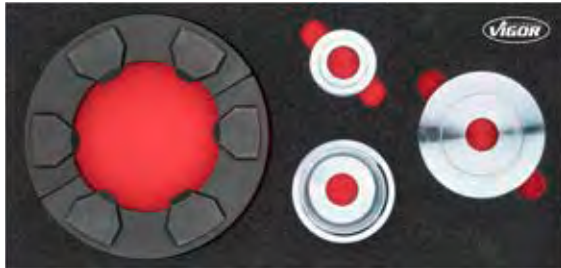

V7263-L, EAN 4047728**072632**

Weichschaum-Einlage · leer



V7267, EAN 4047728**072687**

Erweiterungssatz Naben / Radlager ziehen



V7267-L, EAN 4047728**072670**

Weichschaum-Einlage · leer



V7722, EAN 4047728**077262**

Presstativ Erweiterung



NEU



V7722-L, EAN 4047728**077224**

Weichschaum-Einlage · leer



V7723, EAN 4047728**077279**

Spindel Satz



NEU



V7723-L, EAN 4047728**077231**

Weichschaum-Einlage · leer



Spezial Weichschaum-Einlagen



V7724, EAN 4047728**077286**

Kugelgelenk-Ausdrücker

- Universelles Auspressen von Kugelgelenken mit 4,5 t Druckkraft
- Beinhaltet Hydraulikeinheit V5916 sowie Erweiterungen V5916-1 und V5916-2
- V5916-1: Ausdrücken von Kugelgelenken sowie Spurstangen-Enden, mit Bolzen statt Mutternverschraubungen an der Kegelachse
- V5916-2: Für Kugelgelenksäfte mit einer Länge über 72 mm



NEU



V7724-L, EAN 4047728**079426**

Weichschaum-Einlage · leer



V4906, EAN 4047728**049061**
 Universal Radnaben / Radlager
 Demontage / Montage Satz



V4906-L, EAN 4047728**049054**
 Weichschaum-Einlage · leer



V4906N, EAN 4047728**077255**
 Radlager Satz · Standard ·
 Demontage / Montage



NEU



V4906N-L, EAN 4047728**077217**
 Weichschaum-Einlage · leer



V7201, EAN 4047728**072014**
 Kompakt-Radlager Demontage /
 Montage Satz · universal



V7201-L, EAN 4047728**072021**
 Weichschaum-Einlage · leer



Spezial Weichschaum-Einlagen



V4904, EAN 4047728**049047**
Antriebswellen-Auspressvorrichtung Satz



V5066, EAN 4047728**050661**
Zug- und Druckhülsen Satz



V4904-L, EAN 4047728**049023**
Weichschaum-Einlage · leer



V5066-L, EAN 4047728**050654**
Weichschaum-Einlage · leer



V7261, EAN 4047728**072625**

Transporter Werkzeuge Erweiterung Satz



V7261-L, EAN 4047728**072618**

Weichschaum-Einlage · leer



V7265, EAN 4047728**072663**

Zylinder Satz 32 Tonnen und 8,8 Tonnen



V7265-L, EAN 4047728**072656**

Weichschaum-Einlage · leer



V7270, EAN 4047728**072717**

Hinterachse Erweiterungssatz

• Erweiterungs Satz zum Hinterachs-Radlager-Wechsel bei folgenden Fahrzeugen: CITROËN Jumper · FIAT Ducato · PEUGEOT Boxer · FORD Transit



V7270-L, EAN 4047728**072700**

Weichschaum-Einlage · leer



V7273, EAN 4047728**072748**

Transporter-Starter Satz

- Erhebliche Zeitersparnis durch Anwendung direkt am Fahrzeug · geschätzter Zeitaufwand pro Seite beträgt 30-40 Minuten



V7273-L, EAN 4047728**072731**

Weichschaum-Einlage · leer



V5548, EAN 4047728**055482**

Kompakt-Radlager / -Nabe Erweiterungssatz

- Satz in Weichschaum-Einlage, ohne Multibox



V5548-L, EAN 4047728**055475**

Weichschaum-Einlage · leer



V7154, EAN 4047728**071543**

Bremsscheiben Auspress-Komplett Satz

- Trennen von stark verrosteten und auf der Radnabe festsitzenden Bremsscheiben
- Starkes Hämmern auf die Bremsscheibe kann zur Radlagerbeschädigung führen



V7154-L, EAN 4047728**071710**

Weichschaum-Einlage · leer





Achswellen Demontage Satz



V7862, EAN 4047728078627

Achswellen Demontage Satz

- Demontage der inneren Achswelle von der Getriebe-Einheit
- Durch das vollumfängliche Greifen der Achswelle werden Beschädigungen durch Hämmern oder Ziehen vermieden
- Variable Einstellungen des Achswellen-Halters ermöglichen optimalen Zugriff zur Welle
- Je nach Einbausituation kann der Halter in zwei Teile zerlegt und um die Achswelle gespannt werden
- Universell einstellbarer Halter ermöglicht Einsatz an Kleinwagen bis hin Nutzfahrzeugen
- Verwendung mit 5 kg Schlaghammer V2922



NEU

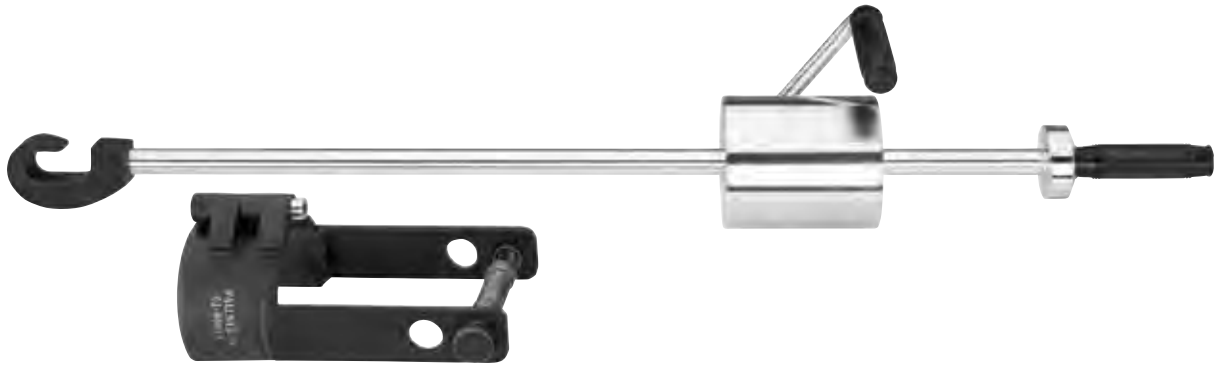

VIGOR No.	Bezeichnung	Ausführung	EAN
V2922	Schlaghammer 5,2 kg		029223
V7980	Achswellen-Demontage Erweiterungssatz		079808



V2889, EAN 4047728028899

Radlager Satz · vorne · CITROËN · FIAT · PEUGEOT

- Für z.B.:
 - CITROËN: Jumper Bj. → 2007
 - FIAT: Ducato Bj. → 2007
 - PEUGEOT: Boxer Bj. → 2007
- Radlagerwechsel direkt am Fahrzeug bei minimalen Zeitaufwand
- Demontage der Radnaben und Lager an dem Fahrwerk mit Hilfe des Hydraulikzylinder 32 Tonnen (V2874) in Verbindung mit Schlagkraft
- Arbeitszeit: 30–40 Minuten je Seite
- Nur einsetzbar in Verbindung mit Lagerscheibe (V2881) und Nabenscheibe (V2882)
- Für Modelle Bj. 2007 → muss Druckring V2883 verwendet werden



VIGOR No.	Bezeichnung	Ausführung	l mm	EAN 4047728+
V3105	Druckring		-	031059
V3107	Druckrohr		180	031073
V3149	Druckrohr		115	031493
V3091	Nabenscheibe · Innen-Ø 23 mm · passend für M 22 Spindel		-	030915
V3108	Lagerscheibe · Innen-Ø 23 mm · passend für M 22 Spindel		-	031080
V3109	Gegenhalter		-	031097
V3106	Druckscheibe Ø 170 mm		-	031066



Druckring für Radlager Satz · vorne · CITROËN · FIAT · PEUGEOT

- Ergänzungswerkzeug für z.B.:
 - CITROËN Jumper Bj. 2007 →
 - FIAT Ducato Bj. 2007 →
 - PEUGEOT Boxer Bj. 2007 →
- Für Fahrzeuge Bj. 2007 → – Einsatz mit V2889
- Statt Druckring Satz V3105, muss dieser Druckring Satz verwendet werden

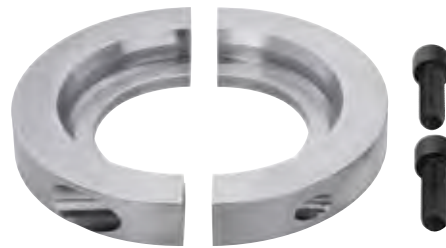

VIGOR No.	EAN 4047728+
V2883	028837

Lagerscheibe für Radlager Satz · vorne · CITROËN · FIAT · PEUGEOT

- Für Radlager Satz, vorne (V2889) benötigt, falls Radlager Satz, hinten (V2880) nicht vorhanden

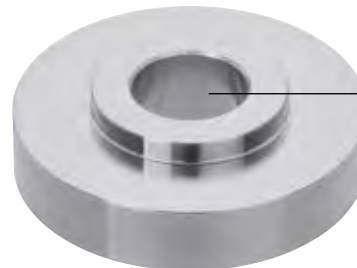

Innendurchmesser 23 mm

VIGOR No.	EAN 4047728+
V2881	028813

Nabenscheibe für Radlager Satz · vorne · CITROËN · FIAT · PEUGEOT

- Für Radlager Satz, vorne (V2889) benötigt, falls Radlager Satz, hinten (V2880) nicht vorhanden

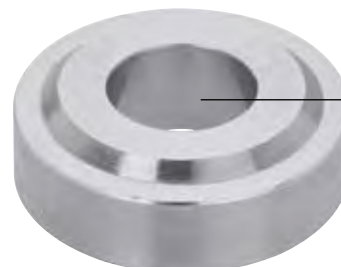

Innendurchmesser 23 mm

VIGOR No.	EAN 4047728+
V2882	028820

Druckhülse

- Ergänzungswerkzeug für oben aufgeführte Modelle Bj. 2010 →
- Statt Lagerschale V3112 muss diese Druckhülse verwendet werden

VIGOR No.	EAN 4047728+
V3433	034333



Druckring für Radlager Satz · vorne · CITROËN · FIAT · PEUGEOT

- Ergänzungswerkzeug für z.B.:
 - CITROËN Jumper Bj. 2007 →
 - FIAT Ducato Bj. 2007 →
 - PEUGEOT Boxer Bj. 2007 →
- Für Fahrzeuge Bj. 2007 → – Einsatz mit V2889
- Statt Druckring Satz V3105, muss dieser Druckring Satz verwendet werden

VIGOR No.	EAN 4047728+
V2883	028837

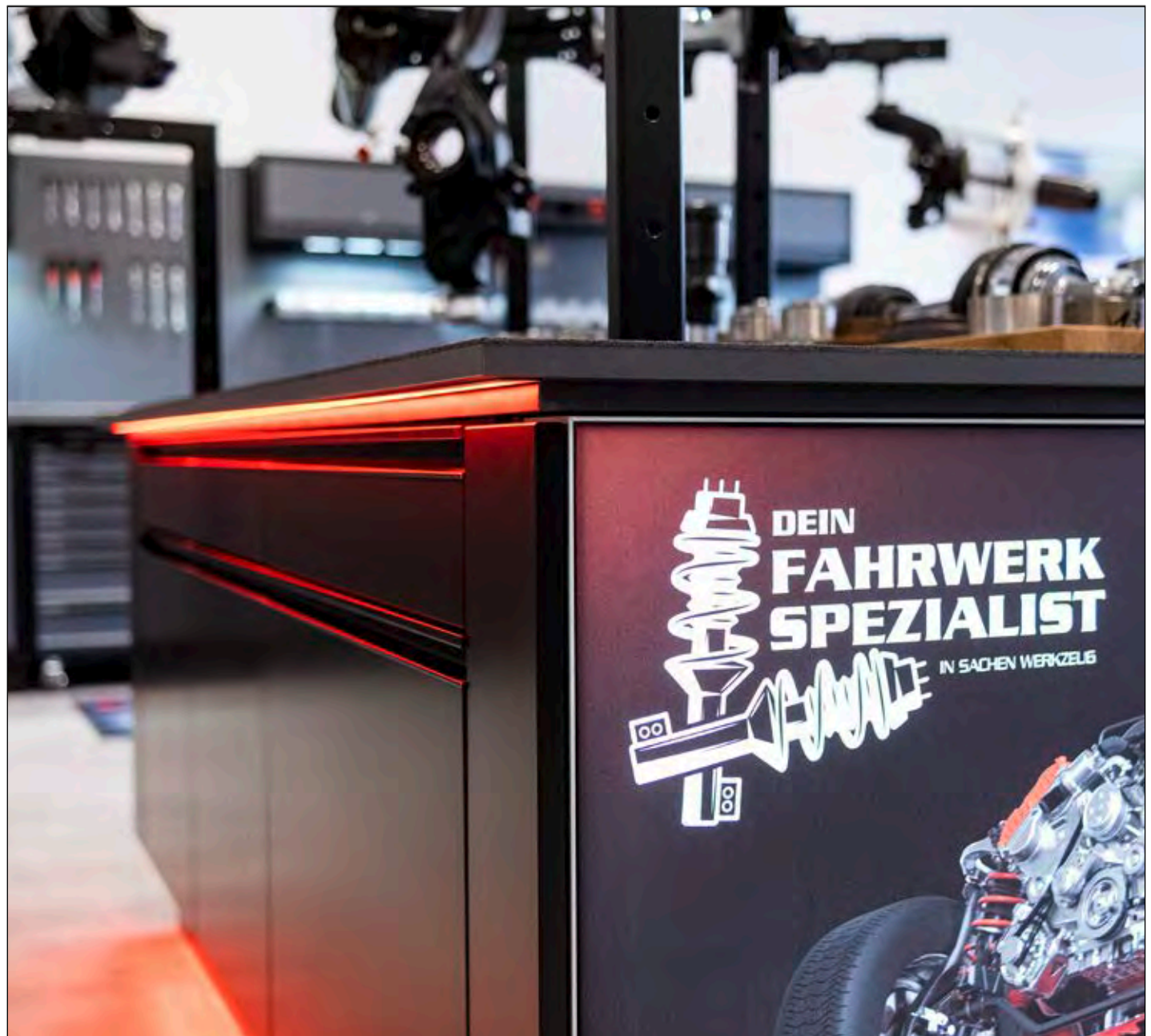

V7252, EAN 4047728072526

Radlager Satz · vorne · IVECO Daily 2014

- Austausch des vorderen Radlagers bei IVECO Daily Modellen Bj. 2014→
- Erhebliche Zeitersparnis durch Verwendbarkeit direkt am Fahrzeug ohne vorherigen Ausbau der Achsteile circa 30 – 40 Minuten Arbeitsaufwand pro Seite
- Pressring für sicheren und verformungslosen Tausch des Radlagers konzipiert
- Verwendung des Satzes in Verbindung mit dem Hydraulikzylinder V2874
- Optional ist zusätzlich das Arbeiten unter der Werkstattpresse möglich



V2879, EAN 4047728028790

Radlager Satz · vorne FORD

- Radlagerwechsel an Vorderachse
- Für FORD Transit (Tourneo) Bj. 2000→
- Wechseln der Bremsscheibe ohne Zerstörung der Radlage
- Für Radlager mit 78 mm Ø und 87,5 mm Ø
- Arbeitszeit: ca. 25 Minuten je Seite
- Radlagerwechsel direkt am Fahrzeug bei minimalem Zeitaufwand



V2890, EAN 4047728028905

Antriebswellen-Werkzeug 5-Loch für Transportfahrzeuge

- Auspressen von verrosteten oder geklebten Antriebswellen direkt am Fahrzeug
- Für Transporter mit 5-Loch-Nabe durch exzentrische Löcher für Radschrauben
- Für Lochkreis 119 – 172 mm
- Vermeidet Erwärmung, Spaltung der Antriebswelle oder Schäden an anderen Teilen

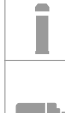

Arbeitsdauer nur
ca. 5 Minuten



V3287, EAN 4047728032872

Spezialmutter · M 16 x 1,5 mm

- In Verbindung mit dem Antriebswellenwerkzeug V2890 zur Demontage von Radlagern (hinten) oder zum Auspressen der Antriebswellen (vorn)
- Für
 - CITROËN Jumper
 - PEUGEOT Boxer
 - FIAT Ducato
 - RENAULT Master
- 5 Muttern erforderlich



V3013, EAN 4047728030137

Spezialmutter · M 14 x 2 mm

- In Verbindung mit dem Antriebswellenwerkzeug V2890 zur Demontage von Radlagern (hinten) oder zum Auspressen der Antriebswellen (vorn)
- Für FORD Transit
- 5 Muttern erforderlich



V7251, EAN 4047728**072540**

Multibox Radlager Satz IVECO Daily

- Austausch der Vorderachs-Radlager im eingebauten Zustand an IVECO Daily Bj. 2014 →
- Verwendung mit 32 t Hydraulikzylinder V2874
- Alternativer Einsatz auch im ausgebauten Zustand unter Zuhilfenahme einer Werkstattpresse



VIGOR No.	Bezeichnung	Ausführung	l mm	EAN 4047728+
V7251-1	Druckring IVECO Daily		-	072557
V7251-2	Großes Druckrohr		-	072519
V7251-3	Lagerscheibe IVECO Daily		-	072564
V7251-4	Nabenscheibe IVECO Daily		-	072571
V7251-5	Lagerschale IVECO Daily		-	072588
V3106	Druckscheibe Ø 170 mm		-	031066
V3108	Lagerscheibe · Innen-Ø 23 mm · passend für M 22 Spindel		-	031080
V3149	Druckrohr		115	031493



V7275, EAN 4047728**07275**.

**Multibox · Starter Satz · Radlager
Transporter Vorderachse**

- Erhebliche Zeitersparnis durch Anwendung direkt am Fahrzeug · geschätzter Zeitaufwand pro Seite beträgt 30-40 Minuten



VIGOR No.	Bezeichnung	Ausführung	mm	XX	EAN 4047728+
V3433	Druckhülse · Innen-Ø 23 mm · passend für M 22 Spindel		-	1	034333
V7251-2	Großes Druckrohr		-	-	072519
V3106	Druckscheibe Ø 170 mm		-	1	031066
V2883	Druckring für Radlager Satz · vorne · CITROËN · FIAT · PEUGEOT		-	4	028837
V2881	Lagerscheibe für CITROËN · FIAT · PEUGEOT Radlager Satz · vorne · Innen-Ø 23 mm · passend für M 22 Spindel		-	1	028813
V3108	Lagerscheibe · Innen-Ø 23 mm · passend für M 22 Spindel		-	1	031080
V3109	Gegenhalter		-	1	031097
V2882	Nabenscheibe für CITROËN · FIAT · PEUGEOT Radlager Satz · vorne		-	1	028820
V3149	Druckrohr		115	1	031493
V3091	Nabenscheibe · Innen-Ø 23 mm · passend für M 22 Spindel		-	1	030915
V3110	Druckscheibe · Ø 89 mm		-	1	031103
V3039	Druckscheibe · groß		-	1	030397
V3040	Druckrohr · groß		120	1	030403
V3087	Nabenwerkzeug		-	1	030878
V3088	Nabenscheibe · Innen-Ø 23 mm · passend für M 22 Spindel		-	1	030885



V7291, EAN 4047728**072915**

Multibox · Erweiterungssatz ·
Radlager Transporter Hinterachse /
Antriebswelle



VIGOR No.	Bezeichnung	Ausführung	∅		EAN 4047728+
V3013	Spezialmutter · M 14x2 mm		-	5	030137
V3287	Spezialmutter · M 16x1,5 mm		-	-	032872
V2890	Antriebswellen-Werkzeug 5-Loch für Transportfahrzeuge		-	1	028905
V3021	Druckhülse		105	1	030212
V3090	Adapterring		-	1	030908



V2858N, EAN 4047728075268

Pressbügel

- Maximale Belastung der Tragjelenke und Pressbügel: 18 t
- Nur in Verbindung mit V2913 · V2915 · V2914
- Für z.B.: FORD und MERCEDES-BENZ

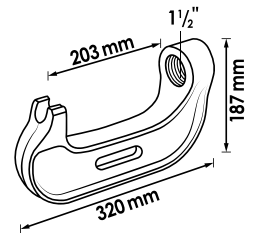

V2920, EAN 4047728029209

Kugelgelenk-Abzieher · universal

- Ausdrücken von Kugelgelenkzapfen aus Lenkhebel bei Transportern, Lkw und Bussen
- Schlanke Bauform – für Kugelgelenke MERCEDES-BENZ Sprinter und FORD Transit

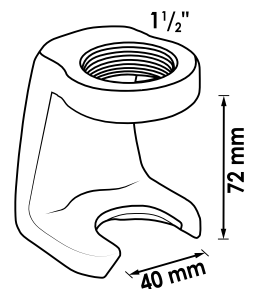

V3678, EAN 4047728036788

Bremsscheiben-Demontage (schwimmend gelagert) · Volvo · RENAULT · DAF

- Demontage von schwimmend gelagerten Bremsscheiben
- Abdrücken der Bremsscheibe durch wechselweises Drücken der Zylinder
- Zwei Spezialzylinder und Zweigege-Steuerventile für wechselweises Pressen
- Nur wenige Minuten zum Abdrücken der Bremsscheibe

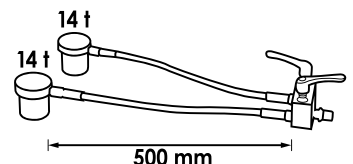

V4565, EAN 4047728**045650**

Achsschenkelbolzen Demontage Satz 32 Tonnen · universal

- Für den Großteil der marktüblichen Achsschenkelbolzen, inklusive Varianten in konischer Form
- Einzigartige Schlagfunktion ermöglicht beim Ausbau Hammerschläge auf Zylinder (mit montiertem Schlagkörper) in Druckrichtung
- Schlagfunktion ist äußerst effektiv und überträgt die für erfolgreichen Ausbau entscheidenden Vibrationen auf das Material
- Kein Ausbau der Achse erforderlich
- 32 Tonnen Version
- Einfache Bedienung, auch für Busse, da bei diesen oft auf engstem Raum gearbeitet wird

Innengewinde 2.1/2"



VIGOR No.	Bezeichnung	Ausführung	L mm	EAN 4047728+
V4550	Pressbügel für V4565 · V4566		-	045506
V3266	Druckrohr		130	032667
V4564	Druckrohr 85 mm für V4565 · V4566		85	045643
V3267	Druckrohr		42	032674
V4634	Druckrohr für V4565 · V4566		-	046343
V4562	Druckhülse für V4565 · V4566		-	045629
V4563	Adapterplatte für V4565 · V4566		-	045636
V3264	Druckstange · 250 mm Ø 31 mm		250	032643
V3265	Druckstange · 140 mm Ø 31 mm		140	032650
V3232	Druckstange · 50 mm Ø 31 mm		50	032322



V4566, EAN 4047728**045667**

Achsschenkelbolzen Demontage Satz 45 Tonnen · universal

- Für den Großteil der marktüblichen Achsschenkelbolzen, inklusive Varianten in konischer Form
- Einzigartige Schlagfunktion ermöglicht beim Ausbau Hammerschläge auf Zylinder (mit montiertem Schlagkörper) in Druckrichtung
- Schlagfunktion ist äußerst effektiv und überträgt die für erfolgreichen Ausbau entscheidenden Vibrationen auf das Material
- Kein Ausbau der Achse erforderlich
- 45 Tonnen Version
- Einfache Bedienung, auch für Busse, da bei diesen oft auf engstem Raum gearbeitet wird



VIGOR No.	Bezeichnung	Ausführung	→ L ← mm	EAN 4047728+
V4550	Pressbügel für V4565 · V4566		-	045506
V3266	Druckrohr		130	032667
V4564	Druckrohr 85 mm für V4565 · V4566		85	045643
V3267	Druckrohr		42	032674
V4634	Druckrohr für V4565 · V4566		-	046343
V4562	Druckhülse für V4565 · V4566		-	045629
V4563	Adapterplatte für V4565 · V4566		-	045636
V4546	Druckstange · M 30 · Länge 140 mm · Ø 38 mm		140	045469
V4545	Druckstange · M 30 · Länge 30 mm · Ø 38 mm		30	045452
V4549	Verlängerung · 100 mm · Ø 38 mm für V4555 · V4566		100	045490
V4548	Verlängerung · 70 mm · Ø 38 mm für V4555 · V4566		70	045483
V4547	Verlängerung · 50 mm · Ø 38 mm für V4555 · V4566		50	045476



V4569, EAN 4047728045698

Achsschenkelbolzen Demontage Erweiterungssatz

Erweiterungs Satz zu den Artikeln V4565 und V4566 System ermöglicht Aus- und Einpressen von Achsschenkelbolzen am Anhänger, ohne die Achse vorher auszubauen



VIGOR No.	Bezeichnung	Ausführung	EAN 4047728+
V4571	Verlängerung für V4569		045711
V4575	Verlängerung für V4569		045759
V4572	Verlängerung für V4569		045728
V4573	Pressplatte für V4569		045735
V4574	Pressplatte für V4569		045742
V4570	Stützbein für V4569		045704



V4605, EAN 4047728046053

Achsschenkelbolzen Demontage Erweiterungssatz MERCEDES-BENZ Actros und Atego

Erweiterungs Satz zu den Artikeln V4565 und V4566 System ermöglicht Aus- und Einpressen von Achsschenkelbolzen direkt am Fahrzeug



VIGOR No.	Bezeichnung	Ausführung	mm	EAN 4047728+
V4575	Verlängerung für V4569		-	045759
V4609	Druckstange · M 30 · Länge 137 mm · Ø 29 mm · für V4605 · V602		137	046091
V4572	Verlängerung für V4569		-	045728
V4607	Führungsring für V4605 · V4606		-	046077
V4610	Zentrierdruckstück		-	046107



V4606, EAN 4047728046060

Achsschenkel Demontage Erweiterungssatz MAN TGA · TGX und TGS

Erweiterungs Satz zu den Artikeln V4565 und V4566 System ermöglicht Aus- und Einpressen von Achsschenkelbolzen direkt am Fahrzeug

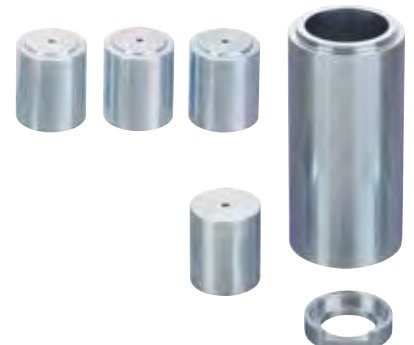

VIGOR No.	Bezeichnung	Ausführung	EAN 4047728+
V4608	Druckrohr		046084
V4575	Verlängerung für V4569		045759
V4572	Verlängerung für V4569		045728
V4607	Führungsring für V4605 · V4606		046077



V4554, EAN 4047728045544

Radnaben-Abzieher Satz Lkw · Busse und Anhänger 32 Tonnen

- Lkw-Radnaben mit 8 Bolzen 275 mm oder 10 Bolzen 335 mm
- Herauspressen von Radnaben mit Kompaktlagern wie z.B. bei SAF-Achsen
- Robuste Konstruktion ermöglicht volle Kraft von 32 Tonnen in Verbindung mit Schlagkraft beim Herauspressen



VIGOR No.	Bezeichnung	Ausführung	← L → mm		EAN 4047728+
V3263	Schraube · M 22x60 mm		-	8	032636
V4556	Platte mit Gewinde für V3750 · V4554 · V4555		-	1	045568
V3265	Druckstange · 140 mm Ø 31 mm		140	1	032650
V3232	Druckstange · 50 mm Ø 31 mm		50	1	032322
V3222	Druckfuß		-	2	032223
V3231	Pressplatte		-	1	032315
V3264	Druckstange · 250 mm Ø 31 mm		250	1	032643



V4555, EAN 4047728045551

Radnaben-Abzieher Satz Lkw · Busse und Anhänger 45 Tonnen

- Lkw-Radnaben mit 8 Bolzen 275 mm oder 10 Bolzen 335 mm
- Herauspressen von Radnaben mit Kompaktlagern wie z.B. bei SAF-Achsen
- Robuste Konstruktion ermöglicht volle Kraft von 45 Tonnen in Verbindung mit Schlagkraft beim Herauspressen



VIGOR No.	Bezeichnung	Ausführung	← L → mm		EAN 4047728+
V3263	Schraube · M 22x60 mm		-	8	032636
V4556	Platte mit Gewinde für V3750 · V4554 · V4555		-	1	045568
V3222	Druckfuß		-	2	032223
V4546	Druckstange · M 30 · Länge 140 mm · Ø 38 mm		140	1	045469
V4545	Druckstange · M 30 · Länge 30 mm · Ø 38 mm		30	1	045452
V4549	Verlängerung · 100 mm · Ø 38 mm für V4555 · V4566		100	1	045490
V4547	Verlängerung · 50 mm · Ø 38 mm für V4555 · V4566		50	1	045476
V4548	Verlängerung · 70 mm · Ø 38 mm für V4555 · V4566		70	1	045483



V3634, EAN 4047728036344

Distanzschraube M 22

- Verwendung in Verbindung mit Radnaben-Abzieher Satz V2934 an Achsen mit Außenplanetengetriebe in der Radnabe
- Lieferung ohne abgebildete Platte (V2932)
- 4 Distanzschrauben zur Verwendung mit V2934 erforderlich
- Höhe: 50 mm



Planetengetriebe



V3434, EAN 4047728034340

Radlager Satz SCANIA

- Schneller, einfacher Wechsel des Radlagers direkt am Fahrzeug
- Nur in Verbindung mit Radnaben-Abzieher Satz V4554
- Enthaltene Schlagmutter ermöglicht beim Ausbau die Nutzung einer Schlagfunktion



**Nur in Verbindung
mit Radnaben-
Abzieher Satz V4554**

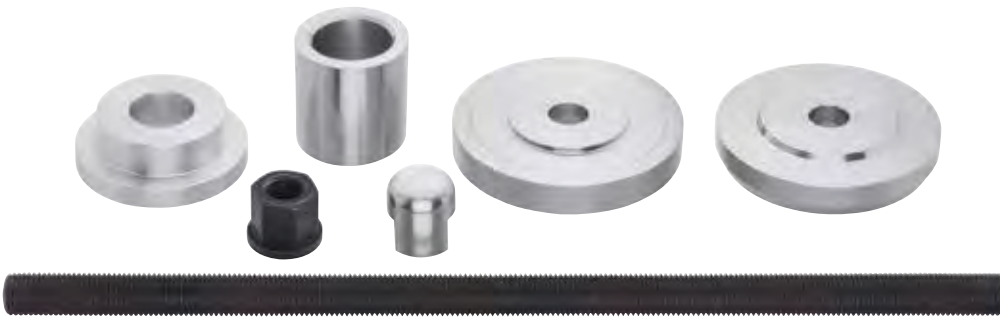

VIGOR No.	Bezeichnung	Ausführung	l mm	EAN 4047728+
V3431	Zugstange · M 22	—	500	034319
V3439	Schutzhülse		-	034395
V3440	Druckhülse		65	034401
V3437*	Druckscheibe · Ø 130 mm		-	034371
V3438*	Druckscheibe · Ø 125 mm		-	034388
V3132	Kragenmutter · M 22x2,5		-	031325
V3092	Schlagmutter		-	030922

* Innendurchmesser 23 mm passend für M 22 Spindel



V4499, EAN 4047728**044998**

Radnaben-Abzieher Nfz · 32 Tonnen

- Auspressen von festgerosteten Lagern mit außenliegenden Naben von geraden Wellen
- Für: Volvo FL · TGS · TGX · MERCEDES-BENZ Atego · Actros · RENAULT Kerax · Magnum · Midlum · Premium
- Kann ebenfalls für baugleiche Marken verwendet werden



VIGOR No.	Bezeichnung	Ausführung	EAN 4047728+
V3867	Adapter für Grundkörper mit Gewinde		038676
V3761	Grundkörper mit Gewinde		037617
V3762	Druckstange · M 24		037624



V4500, EAN 4047728**045001**

Radnaben-Abzieher Nfz · 45 Tonnen

- Auspressen von festgerosteten Lagern mit außenliegenden Naben von geraden Wellen
- Für: Volvo FL · TGS · TGX · MERCEDES-BENZ Atego · Actros · RENAULT Kerax · Magnum · Midlum · Premium
- Kann ebenfalls für baugleiche Marken verwendet werden



VIGOR No.	Bezeichnung	Ausführung	EAN 4047728+
V3867	Adapter für Grundkörper mit Gewinde		038676
V3761	Grundkörper mit Gewinde		037617
V4577	Druckstange · M 30 für V4500		045773



V3750, EAN 4047728**037501**

Nabenabzieher für niedrig gebaute Anhänger

- Auspressen der 225 mm-Nabe mit 10 Schrauben
- Naben mit Einheitslager an geraden Wellen lassen sich dadurch lösen



VIGOR No.	Bezeichnung	Ausführung		EAN 4047728+
V3263	Schraube · M 22x60 mm		8	032636
V3763	Platte		2	037631
V3764	Schenkel		4	037648
V3765	Druckscheibe · SAF Ø 73 mm		1	037655

Nur in Verbindung mit Gewindeplatte V4556 (nicht enthalten)

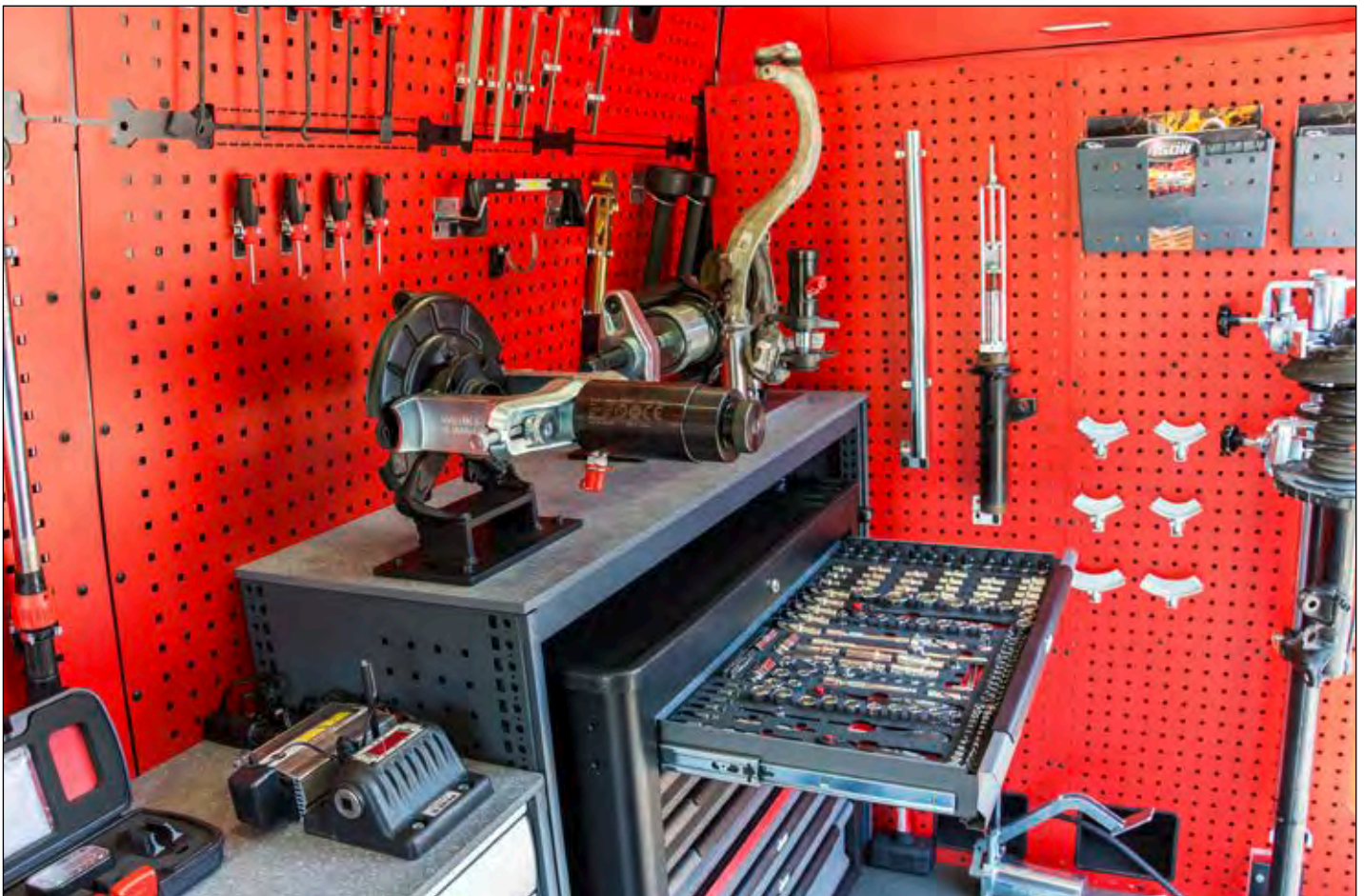

V4601, EAN 4047728046015

Federbolzen Satz SCANIA 32 Tonnen

- Auspressen von Federbolzen
- Verwendung zusammen mit Platte V4556 für Pressbügel und 32 Tonnen Hydraulikzylinder V2874 (nicht enthalten)
- Bei festgerosteten Bolzen eingebaute Schlagfunktion verwenden (oftmals entscheidend für erfolgreichen Ausbau)
- Arbeit erfolgt direkt am Fahrzeug bei minimalem Teileausbau



VIGOR No.	Bezeichnung	Ausführung	← L → mm	XX	EAN 4047728+
V3262	Pressbügel		-	3	032629
V3259	Druckrohr · groß		60	1	032599
V3261	Druckstange · 115 mm Ø 29 mm		115	1	032612
V3263	Schraube · M 22x60 mm		-	8	032636
V3260	Druckstange · 100 mm Ø 29 mm		100	1	032605



V4602, EAN 4047728046022

Federbolzen Satz SCANIA 45 Tonnen

- Auspressen von Federbolzen
- Verwendung zusammen mit Platte V4556 für Pressbügel und 45 Tonnen Hydraulikzylinder V4242 (nicht enthalten)
- Bei festgerosteten Bolzen eingebaute Schlagfunktion verwenden (oftmals entscheidend für erfolgreichen Ausbau)
- Arbeit erfolgt direkt am Fahrzeug bei minimalem Teileausbau



VIGOR No.	Bezeichnung	Ausführung	← L → mm	XX	EAN 4047728+
V3262	Pressbügel		-	3	032629
V3259	Druckrohr · groß		60	1	032599
V4609	Druckstange · M 30 · Länge 137 mm · Ø 29 mm · für V4605 · V602		137	1	046091
V3263	Schraube · M 22x60 mm		-	8	032636
V4602-1	Druckstange Länge 64 mm Ø 29 mm		64	2	046336



V2937, EAN 4047728**029377**

Abzieher Bremshebelarme

- Ausdrücken von festgerosteten Nockenwellen aus Bremshebelarmen
- Für fast alle marktüblichen Hebelarme, geeignet auch für Haldex und BPW
- Sehr kompakte Ausführung gewährleistet flexiblen Einsatz in engen Bereichen am Fahrzeug



Innengewinde 1. 1/2"

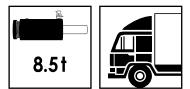
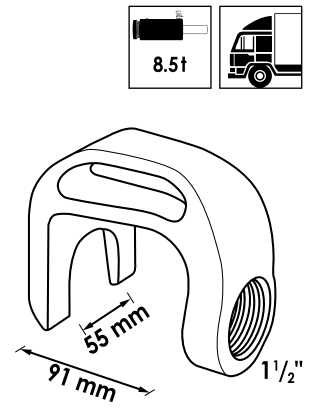

V4635, EAN 4047728**046350**

Federbuchsen Satz · universal

- Wechsel der Federbuchsen ohne unnötige Ausbaurbeiten
- Inklusive Werkzeugteile zum Auswechseln der Feder-Gelenkbuchse
- Für Buchsen der Größen 44 bis 63 mm
- Problemloses Entfernen selbst festgerosteter Buchsen dank Schlagfunktion



VIGOR No.	Bezeichnung	Ausführung	L mm	EAN 4047728+
V3127	Zugstange · M 18 M 22 · maximal 22 t		250	031271
V3126	Kragenmutter · M 18x2,5		-	031264
V3266	Druckrohr		130	032667
V3267	Druckrohr		42	032674
V3235*	Druckscheibe · Ø 44 mm		-	032353
V3236*	Druckscheibe · Ø 50 mm		-	032360
V3233*	Druckscheibe · Ø 57 mm		-	032339
V3237*	Druckscheibe · Ø 63 mm		-	032377
V3234*	Druckscheibe · Ø 63 mm		-	032346

* Innendurchmesser 23 mm passend für M 22 Spindel



V2936, EAN 4047728029360

Buchsen Satz · SAF-Achse · 150 mm

- Schnelle, einfache Demontage / Montage der großen Gummibuchsen 150 mm bei SAF-Achsen

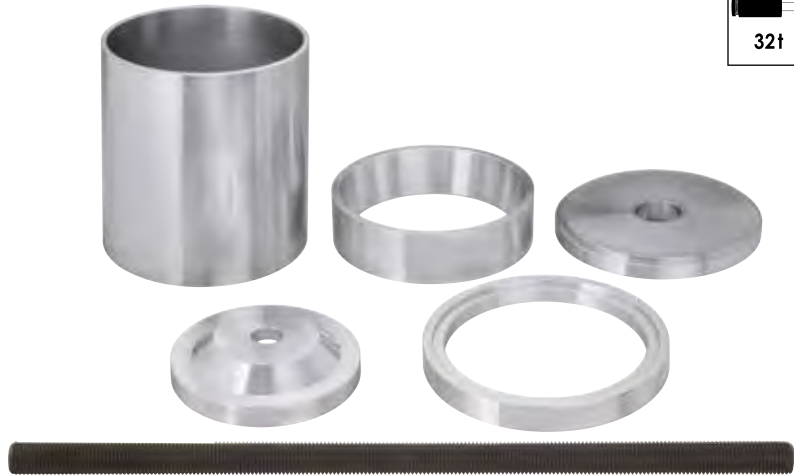
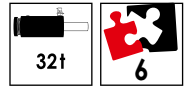

VIGOR No.	Bezeichnung	Ausführung	L mm	EAN 4047728+
V3107	Druckrohr		180	031073
V3225	Demontage- / Montagering		-	032254
V3106*	Druckscheibe Ø 170 mm		-	031066
V3224*	Demontage- / Montagescheibe		-	032247
V3226	Montagering		-	032261
V3431	Zugstange · M 22		500	034319

* Innendurchmesser 23 mm passend für M 22 Spindel



V2942, EAN 4047728029421

Buchsen Satz für Deichseln

- Buchsenwechsel mit 32 Tonnen Hydraulikzylinder V2874 (nicht enthalten) mit Schlagfunktion direkt an der Deichsel
- Universell einsetzbar, insbesondere für Buchsen und Deichseln von V&G
- Buchsenwechsel ohne Erwärmung oder sonstige Bearbeitung

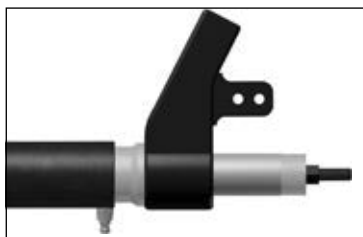
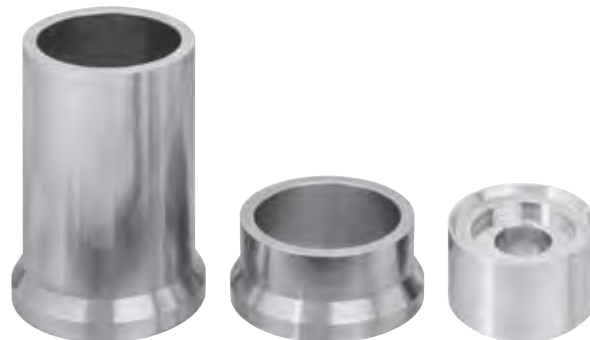
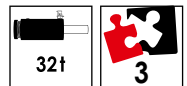

VIGOR No.	Bezeichnung	Ausführung	L mm	EAN 4047728+
V3266	Druckrohr		130	032667
V3267	Druckrohr		42	032674
V3238*	Druckscheibe		-	032384

* Innendurchmesser 23 mm passend für M 22 Spindel



V4603, EAN 4047728**046039**

Druckwerkzeug Satz 32 Tonnen · universal

- Schneller Wechsel von konisch- und zylindrischen Achsschenkelbolzen, Federbuchsen und Deichselbolzen sowie großer Sicherungsringe
- Im Satz enthalten:
 - Demontagewerkzeuge für Kugelgelenke, Bremshebelarme, VB&G-Deichselbolzen
 - Werkzeuge zum Auspressen von Radnaben
 - 8,5 Tonnen und 32 Tonnen Hydraulikzylinder inklusive Spindel und Schlagkörper



VIGOR No.	Bezeichnung	Ausführung	mm	XX	EAN 4047728+
V4565	Achsschenkelbolzen Demontage Satz 32 Tonnen · universal		-	10	045650
V5916-XL	Kugelgelenk-Ausdrücker · hydraulisch 8,8 Tonnen		-	3	066471
V2867N	Sicherungsring-Werkzeug		-	7	077859
V2874	Druck- und Zug-Hydraulikzylinder 32 Tonnen		223	8	028745
V3222	Druckfuß		-	2	032223



V4604, EAN 4047728**046046**

Druckwerkzeug Satz 45 Tonnen · universal

- Schneller Wechsel von konisch- und zylindrischen Achsschenkelbolzen und Deichselbolzen sowie großer Sicherungsringe
- Im Satz enthalten:
 - Demontagewerkzeuge für Kugelgelenke, Bremshebelarme, VB&G-Deichselbolzen
 - Werkzeuge zum Auspressen von Radnaben
 - 8,5 Tonnen und 45 Tonnen Hydraulikzylinder inklusive Spindel und Schlagkörper



VIGOR No.	Bezeichnung	Ausführung	mm	XX	EAN 4047728+
V4666	Schraubendreher · flexibel		300	-	046664
V5916-XL	Kugelgelenk-Ausdrücker · hydraulisch 8,8 Tonnen		-	3	066471
V2867N	Sicherungsring-Werkzeug		-	7	077859
V2874	Druck- und Zug-Hydraulikzylinder 32 Tonnen		223	8	028745
V3222	Druckfuß		-	2	032223



Wallmek-No	VIGOR No.	Bezeichnung	Seite
01-00001-001	V2945	Adapterplatte für V2868	357
01-00001-002	V2946	Druckstange · verstellbar · 90 mm für V2868	357
01-00001-101	V2947	Presshülse	356
01-00001-102	V2948	Presshülse	356
01-00001-103	V2949	Presshülse	356
01-00001-104	V2950	Presshülse	356
01-00001-105	V2961	Presshülse	356
01-00001-106	V2962	Presshülse	356
01-00001-107	V2963	Presshülse	356
01-00001-108	V2964	Presshülse	356
01-00001-109	V2965	Presshülse	356
01-00001-110	V2966	Presshülse	356
01-00001-201	V2967	Pressrohr	356
01-00001-202	V2968	Pressrohr	356
01-00001-203	V2969	Pressrohr	356
01-00001-204	V2971	Pressrohr	356
01-00001-205	V2972	Pressrohr	356
01-00001-206	V2973	Pressrohr	356
01-00001-207	V2974	Pressrohr	356
01-00001-208	V2975	Pressrohr	357
01-00001-209	V2976	Pressrohr	357
01-00001-210	V2977	Pressrohr	357
01-00001-211	V2978	Pressrohr	357
01-00001-212	V2979	Pressrohr	357
01-00001-213	V2980	Pressrohr	357
01-00001-214	V2981	Pressrohr	357
01-00001-400	V5169-A	Druckhülsen-Erweiterungssatz	357
01-00001-401	V5169-A45	Adapter Presshülsen · 45 mm	357
01-00001-402	V5169-A55	Adapter Presshülsen · 55 mm	357
01-00001-403	V5169-A70	Adapter Presshülsen · 70 mm	357
01-00001-404	V5169-A76	Adapter Presshülsen · 76 mm	357
01-00001-405	V5169-A80	Adapter Presshülsen · 80 mm	357
01-00001-999	V5066	Zug- und Druckhülsen Satz	391
01-00004	V2867N	Sicherungsring-Werkzeug	330, 414–415
01-00004-013	V2992	Stift Ø 2,5 mm	330
01-00004-014	V2993	Stift Ø 3,0 mm	330
01-00004-015	V2994	Stift Ø 3,5 mm	330
01-00018	V2860	Kompakt-Radlager Demontage Satz · universal	335, 351
01-00018-003	V3873	Fixierschraube · M 14	332, 335, 337, 343

Wallmek-No	VIGOR No.	Bezeichnung	Seite
01-00018-004	V3874	Schraube · M 12	332, 335, 337, 343
01-00020	V2853	Spindel Satz · mechanisch	329
01-00020-001	V3008	Zugstange mit Kragenmutter M 18	329
01-00020-002	V3206	Unterlegscheibe	329
01-00020-003	V3205	Druckscheibe	329
01-00022-003	V3403	Druckrohr	369
01-00022-004	V3404	Druckplatte	369
01-00022-005	V3405	Adapterring	369
01-00022-010	V3649	Buchsen Satz Längsstrebe · FORD · Volvo	350, 369
01-00022-020	V3650	Pressrahmen	369
01-00026	V3731	Demontage Satz, universal, für geschraubte Radlagereinheit	337
01-00026-020	V3758	Druckfuß Satz (Demontage) für geschraubte Radlagereinheiten	337, 348–349
01-00027	V3732	Demontage Satz, universal, für geschraubte Radlagereinheit	337
01-00027-020	V3753	Druckfuß Satz (Demontage) für geschraubte Radlagereinheiten	337, 348–349
01-00030	V4551	Druck- und Zug-Hydraulikzylinder 18 Tonnen	323
01-00030-001	V4552	Hydraulik-Zylinder · 18 Tonnen · ohne Zubehör	323
01-00030-005	V4553	Druckachse · M 24x3 mm	323
01-00031-018	V4342	Schlagmutter · M 18	326
01-00033	V4491	Kompakt-Radlager Montage Satz · universal	343
01-00033-020	V4493	Druckfuß (Paar) für Kompakt-Radlager-Montagewerkzeug Satz · universal	343
01-00033-110	V3680	Kompakt-Radlager Montage Satz · universal	351
01-00035	V4598	Radlager-, Antriebsachsen und Radnaben Satz · universal	333, 347
01-00035-001	V4614	Nabenscheibe · konisch · Ø 33,8 mm · für V4598	333, 348
01-00035-002	V4598-2	Nabenscheibe · konisch · Ø 38,8 mm · für V4598	333, 348, 363
01-00035-003	V4598-3	Nabenscheibe · konisch · Ø 43,8 mm · für V4598 · V4599	333–334, 348
01-00035-004	V4598-4	Nabenscheibe · konisch · Ø 59,8 mm · für V4598	333, 348
01-00035-010	V4598-10	Lagerscheibe Ø 61,8 – 62,8 mm · Innenloch-Ø 20,25 mm · passend für Spindel M 20	333

Umschlüsselung Wallmek / VIGOR



Wallmek-No	VIGOR No.	Bezeichnung	Seite
01-00035-011	V4598-11	Lagerscheibe \varnothing 63,8 – 64,8 mm · Innenloch- \varnothing 20,25 mm · passend für Spindel M 20	333
01-00035-012	V4598-12	Lagerscheibe \varnothing 65,8 – 66,8 mm · Innenloch- \varnothing 20,25 mm · passend für Spindel M 20	333–334
01-00035-013	V4598-13	Lagerscheibe \varnothing 68,8 – 70,8 mm · Innenloch- \varnothing 20,25 mm · passend für Spindel M 20	333
01-00035-014	V4598-14	Lagerscheibe \varnothing 72,5 – 74,5 mm · Innenloch- \varnothing 20,25 mm · passend für Spindel M 20	333
01-00035-015	V4598-15	Lagerscheibe \varnothing 76,5 – 78,5 mm · Innenloch- \varnothing 20,25 mm · passend für Spindel M 20	333
01-00035-016	V4598-16	Lagerscheibe \varnothing 80,8 – 82,8 mm · Innenloch- \varnothing 20,25 mm · passend für Spindel M 20	333
01-00035-020	V4598-20	Lagerschale \varnothing 93 mm für V4598	333
01-00035-021	V4598-21	Lagerschale \varnothing 75,5 mm für V4598	333
01-00035-022	V4598-22	Lagerschale \varnothing 93 mm für V4598	333
01-00035-030	V4598-30	Druckrohr Länge 78 mm für V4598 · V4599	333–334, 348
01-00036	V4594	Radlager-Fixierung · verstellbar	334
01-00036-020	V4594-1	Druckfuß Satz für V4594	334
01-00037	V4629	Radnaben Demontage-Werkzeug · universal	332, 347
01-00037-020	V4629-1	Druckfuß Satz für V4629	332, 348
01-00038	V4599	Radlager Satz AUDI Q7 · VW Touareg · PORSCHE Cayenne	334
01-00039	V4699	Druckspindel Satz · manuell	329
01-00039-001	V4699-1	Druckspindel · M 30	329
01-00039-002	V4699-2	Adapter · 1,1/2" · M 30	329
01-00039-010	V4699-4	Press-Achse · 50x \varnothing 19 mm	329
01-00039-011	V4699-5	Press-Achse · 85x \varnothing 19 mm	329
01-00039-020	V4699-6	Press-Achse · 56x \varnothing 24 mm	329
01-00039-021	V4699-7	Press-Achse · 100x \varnothing 24 mm	329
01-00039-040	V4699-3	Scheibe \varnothing 18,8x3 mm (4 Stk.)	329
01-00040	V5027	Radnaben-Abzieher	341, 345, 349, 360
01-00041-002	V3871	Traverse für diverse Druckfüsse	332, 335, 337, 343, 346, 359
01-00041-003	V5904-3	Gleitteller	346, 359
01-00041-005	V5904-4	Schraube · M 14 x 2 – 45 · Innensechskant	346, 359
01-00041-020	V3755	Druckfuß Satz (Demontage) für Kompakt-Radlager	335
01-00042-003	V5903-3	Zugstange · M 22 · 121 mm	342
01-00042-010	V7061	Schrauben Satz · SUBARU · Hinterradlager	341
01-00042-011	V7071	Schrauben Satz · VAG	341

Wallmek-No	VIGOR No.	Bezeichnung	Seite
01-00042-B	V5903N	Radlager-Abzieher für geschraubte Radlager	342, 349
01-00044	V5904	Antriebswellen-Auspressvorrichtung · 6- und 8-Loch	346
01-00044-030	V5904-1	Druckfuß Satz	346
01-00045	V5905	Radnaben- / Radlager-Abzieher · für 6 und 8 Bolzen	344–345, 360
01-00046	V5906	Radlagereinheit · geschraubt · Demontage Satz · universal	343, 345
01-00046-020	V5906-1	Druckfuß Satz	343
01-00046-100	V7859	Radlager Demontage Satz · Steckachsen	345
01-00046-111	V7860	Abstützbacken Satz	345
01-00047-020	V7050	Demontagewerkzeug für geschraubte 4-Loch Naben / Radlager mit unebenem Bremsenschutzblech	335
01-00048	V7154	Bremsscheiben Auspress-Komplett Satz	393
01-00048-001	V7154-1	Auspress Fuß · einzeln	359
01-00048-002	V7154-2	Fixierplatte · einzeln	359
01-00048-030	V7154N	Erweiterungssatz für Bremsscheiben-Ausdrückwerkzeug · ohne Traverse	346
01-00049	V7027	Radnaben- / Lagerabzieher	344
01-00050-010	V5422	Lagerplatte · \varnothing 85-95 mm	339
01-00050-011	V5423	Halteplatte · \varnothing 89-105 mm	339
01-00050-020	V5421	Erweiterungssatz · ROVER	339
01-00050-050	V5425	Standard Radlager Erweiterungssatz ROVER	338
01-00050-100	V5420	Standard Radlager Demontage / Montage Satz ROVER	338
01-00053	V7862	Achswellen Demontage Satz	395
01-00054	V7865	Silentlager Buchsen Satz · VAG	373
02-00009	V2923	Traggelenk Satz FORD	370
02-00009-001	V2999	Druckhülse	370
02-00009-002	V3000	Montage- / Demontagedeckel	370
02-00009-003	V3001	Montagehülse	370
02-00009-004	V3002	Demontagehülse	370
02-00010-001	V3433	Druckhülse · Innen- \varnothing 23 mm · passend für M 22 Spindel	397, 401
02-00011	V7252	Radlager Satz · vorne · IVECO Daily 2014	398
02-00011-001	V7251-1	Druckring IVECO Daily	400
02-00011-002	V7251-2	Großes Druckrohr	400–401
02-00011-003	V7251-3	Lagerscheibe IVECO Daily	400
02-00011-004	V7251-4	Nabenscheibe IVECO Daily	400
02-00011-005	V7251-5	Lagerschale IVECO Daily	400
02-00015	V7133	Kompakt-Radlager Demontage / Montage Satz	360

Wallmek-No	VIGOR No.	Bezeichnung	Seite
02-00015-001	V7133-2	Einpress-Gewinde mit Führung M24 · L 110 mm	361
02-00015-002	V7133-3	Einpress-Traverse CC = 160–186 mm · L 226 mm	361
02-00015-003	V7133-4	Einpress-Befestigung L 266 mm · M14 · M16	361
02-00015-004	V7133-5	Fixierschraube M14 konisch	361
02-00015-005	V7133-6	Einpress-Holme L 242 mm · 2x M14	361
02-00015-006	V7133-7	Einpress-Platte CC = 135–145 mm	361
02-00015-007	V7133-8	Befestigung Achsschenkel M14	361
03-00003-005	V3263	Schraube · M 22x60 mm	407, 410–411
03-00004-001	V3262	Pressbügel	411
03-00005-001	V2937	Abzieher Bremshebelarme	412
03-00006-001	V3264	Druckstange · 250 mm Ø 31 mm	404, 407
03-00006-002	V3265	Druckstange · 140 mm Ø 31 mm	404, 407
03-00006-006	V3266	Druckrohr	404–405, 412–413
03-00006-007	V3267	Druckrohr	404–405, 412–413
03-00006-009	V3261	Druckstange · 115 mm Ø 29 mm	411
03-00006-010	V3260	Druckstange · 100 mm Ø 29 mm	411
03-00006-011	V3259	Druckrohr · groß	411
03-00006-013	V3238	Druckscheibe	413
03-00006-014	V3237	Druckscheibe · Ø 63 mm	412
03-00006-015	V3236	Druckscheibe · Ø 50 mm	412
03-00006-016	V3235	Druckscheibe · Ø 44 mm	412
03-00006-017	V3234	Druckscheibe · Ø 63 mm	412
03-00006-018	V3233	Druckscheibe · Ø 57 mm	412
03-00006-020	V3232	Druckstange · 50 mm Ø 31 mm	404, 407
03-00006-021	V3231	Pressplatte	407
03-00006-025	V3634	Distanzschraube M 22	408
03-00006-026	V3440	Druckhülse	408
03-00006-027	V4634	Druckrohr für V4565 · V4566	404–405
03-00006-028	V4563	Adapterplatte für V4565 · V4566	404–405
03-00006-029	V4564	Druckrohr 85 mm für V4565 · V4566	404–405
03-00006-030	V4562	Druckhülse für V4565 · V4566	404–405
03-00008-32T	V4601	Federbolzen Satz SCANIA 32 Tonnen	411
03-00008-45T	V4602	Federbolzen Satz SCANIA 45 Tonnen	411
03-00009	V4635	Federbuchsen Satz · universal	412
03-00010	V2942	Buchsen Satz für Deichseln	413
03-00013	V2936	Buchsen Satz · SAF -Achse · 150 mm	413
03-00013-001	V3226	Montagering	413
03-00013-002	V3225	Demontage- / Montagering	413

Wallmek-No	VIGOR No.	Bezeichnung	Seite
03-00013-003	V3224	Demontage- / Montagescheibe	413
03-00014-001	V2920	Kugelgelenk-Abzieher · universal	403
03-00015	V2873	Druck- und Zug-Hydraulikzylinder 8,5 Tonnen	322
03-00015-001	V3009	Hydraulik-Zylinder · 8,5 Tonnen	322
03-00015-006	V3010	Schlagkörper mit O-Ring	322
03-00015-012	V3011	Druckstange · verstellbar M 22	322
03-00016-020	V3222	Druckfuß	407, 414–415
03-00016-32T	V4554	Radnaben-Abzieher Satz Lkw · Busse und Anhänger 32 Tonnen	407
03-00016-45T	V4555	Radnaben-Abzieher Satz Lkw · Busse und Anhänger 45 Tonnen	407
03-00020	V3434	Radlager Satz SCANIA	408
03-00020-001	V3437	Druckscheibe · Ø 130 mm	408
03-00020-002	V3438	Druckscheibe · Ø 125 mm	408
03-00020-003	V3439	Schutzhülse	408
03-00021-020	V4603	Druckwerkzeug Satz 32 Tonnen · universal	414
03-00021-021	V4604	Druckwerkzeug Satz 45 Tonnen · universal	415
03-00022	V3750	Nabenabzieher für niedrig gebaute Anhänger	410
03-00022-001	V3763	Platte	410
03-00022-002	V3764	Schenkel	410
03-00022-003	V3765	Druckscheibe · SAF Ø 73 mm	410
03-00025	V3678	Bremsscheiben-Demontage (schwimmend gelagert) · Volvo · RENAULT · DAF	403
03-00026	V4229	Druck- und Zug-Hydraulikzylinder 45 Tonnen	324
03-00026-001	V4242	Hydraulik-Zylinder 45 Tonnen	324
03-00026-006	V4254	Schlagkörper · M 27	324
03-00026-012	V4251	Druckstück · verstellbar · M 30	324
03-00027-002	V3762	Druckstange · M 24	409
03-00027-003	V4577	Druckstange · M 30 für V4500	409
03-00027-010	V3761	Grundkörper mit Gewinde	409
03-00027-012	V3867	Adapter für Grundkörper mit Gewinde	409
03-00027-32T	V4499	Radnaben-Abzieher Nfz · 32 Tonnen	409
03-00027-45T	V4500	Radnaben-Abzieher Nfz · 45 Tonnen	409
03-00028	V2874	Druck- und Zug-Hydraulikzylinder 32 Tonnen	324, 414–415
03-00028-001	V3216	Hydraulik-Zylinder · 32 Tonnen	324
03-00031-001	V4550	Pressbügel für V4565 · V4566	404–405
03-00031-002	V4556	Platte mit Gewinde für V3750 · V4554 · V4555	407

Wallmek-No	VIGOR No.	Bezeichnung	Seite
03-00031-200	V4569	Achsschenkelbolzen Demontage Erweiterungssatz	406
03-00031-201	V4570	Stützbein für V4569	406
03-00031-202	V4571	Verlängerung für V4569	406
03-00031-203	V4575	Verlängerung für V4569	406
03-00031-204	V4572	Verlängerung für V4569	406
03-00031-205	V4573	Pressplatte für V4569	406
03-00031-206	V4574	Pressplatte für V4569	406
03-00031-220	V4605	Achsschenkelbolzen Demontage Erweiterungssatz MERCEDES-BENZ Actros und Atego	406
03-00031-221	V4610	Zentrierdruckstück	406
03-00031-300	V4606	Achsschenkel Demontage Erweiterungssatz MAN TGA · TGX und TGS	406
03-00031-302	V4608	Druckrohr	406
03-00031-303	V4607	Führungsring für V4605 · V4606	406
03-00031-32T	V4565	Achsschenkelbolzen Demontage Satz 32 Tonnen · universal	404, 414
03-00031-45T	V4566	Achsschenkelbolzen Demontage Satz 45 Tonnen · universal	405
03-00032-001	V4545	Druckstange · M 30 · Länge 30 mm · Ø 38 mm	405, 407
03-00032-002	V4546	Druckstange · M 30 · Länge 140 mm · Ø 38 mm	405, 407
03-00032-003	V4547	Verlängerung · 50 mm · Ø 38 mm für V4555 · V4566	405, 407
03-00032-004	V4548	Verlängerung · 70 mm · Ø 38 mm für V4555 · V4566	405, 407
03-00032-005	V4549	Verlängerung · 100 mm · Ø 38 mm für V4555 · V4566	405, 407
03-00032-101	V4609	Druckstange · M 30 · Länge 137 mm · Ø 29 mm · für V4605 · V602	406, 411
03-00032-102	V4602-1	Druckstange Länge 64 mm Ø 29 mm	411
04-00003	V4255	Manometer	331
04-00007-001	V3287	Spezialmutter · M 16x1,5 mm	399, 402
04-00007-004	V3013	Spezialmutter · M 14x2 mm	399, 402
04-00015-001	V3582	Einklemmschutz	328
04-00016	V3612	Manometer	328
04-00021	V4218	Halterungs Satz für Hydraulik-Zylinder	325
04-00021-001	V4243	Halterung ohne Schelle	325
04-00021-013	V4244	Schelle Ø 70 mm	325
04-00021-014	V4245	Schelle Ø 85 mm	325
04-00021-015	V4246	Schelle Ø 100 mm	325
04-00024	V5916	Kugelgelenk-Ausdrücker · hydraulisch 4,5 Tonnen	364

Wallmek-No	VIGOR No.	Bezeichnung	Seite
04-00024-023	V5916-1	Kugelgelenk-Ausdrücker Erweiterung Pins	364
04-00024-024	V5916-2	Druckfuß-Erweiterung	364
04-00028	V5916-XL	Kugelgelenk-Ausdrücker · hydraulisch 8,8 Tonnen	355, 365, 414-415
09-000111	V7133-9	Gewindehülse 28x14,5x3 mm	361
1-1090-02	V3199	Hydraulik-Zylinder · 22 Tonnen	323
1-1090-03	V3217	Hydraulik-Zylinder · 14 Tonnen	322
1030	V2847	Hydraulische Fußpumpe	331, 352
1036	V2846	Hydraulikpumpe · pneumatisch	331, 353
1064	V2922	Schlaghammer 5,2 kg	363, 395
1066	V2871	Radnaben Demontage Satz für V2922	363
1068	V2872	Adapter für Schlaghammer V2922	363
1068-04	V2851	Adapter für andere Werkzeugsysteme	327
1068-05	V2910	Adapter ½" auf G2-½" - 11	327
1068-06	V2850	Adapter für andere Werkzeugsysteme	327
1068-08	V3869	Adapter für andere Werkzeugsysteme	327
1068-09	V3870	Adapter für andere Werkzeugsysteme	327
1068-10	V4220	Adapter für andere Werkzeugsysteme	328
1086-6	V3018	Schlagkörper · M 22x2,5 mm	323-324
1090-02-WAL	V2854	Druck- und Zug-Hydraulikzylinder 22 Tonnen	323, 352-353, 358
1090-03	V2869	Druck-Hydraulikzylinder 14 Tonnen	322, 355
1090-15-B	V3021	Druckhülse	402
1090-20-02	V3033	Nabenscheibe Ø 32 mm · Innenloch-Ø 20,25 mm · passend für Spindel M 20	363
1090-20-06	V3035	Nabenscheibe Ø 45 mm · Innenloch-Ø 20,25 mm · passend für Spindel M 20	363
1090-20-08	V3036	Nabenscheibe Ø 52 mm · Innenloch-Ø 20,25 mm · passend für Spindel M 20	363
1090-20-M	V3060	Gegenhalter	333-334
1090-20-T21	V3070	Lagerscheibe Ø 92 mm	334
1090-20-T22	V3071	Lagerscheibe Ø 95 mm · Innenloch-Ø 20,25 mm · passend für Spindel M 20	334
1090-25-10	V2864	Demontagescheibe · konisch · universal	336, 351
1090-25-11	V2861	Gegenhalteplatte (Montage) VW · AUDI · SEAT · ŠKODA	340
1090-25-12	V2862	Gegenhalteplatte (Montage) VW	340
1090-25-13	V2863	Montagering FORD · MAZDA · Volvo	340
1090-25-14	V2859	Gegenhalteplatte (Montage) FORD · MAZDA · Volvo	340
1090-25-15	V6824	Halbschalen Satz für die Montage von 92 mm Kompakt-Radlager	336
1090-26	V2845	Lager- und Nabenschale	332
1090-26-01	V3039	Druckscheibe · groß	332, 401

Wallmek-No	VIGOR No.	Bezeichnung	Seite
1090-26-02	V3040	Druckrohr · groß	332, 401
1090-30	V2849	Antriebswellen-Auspressvorrichtung · 4- und 5-Loch	358, 362
1090-30-4	V3147	Antriebswelle 4-Loch · Lochkreis 92 – 120 mm	362
1090-30-5	V3148	Antriebswelle 5-Loch · Lochkreis 98 – 131 mm	362
1090-32	V3207	Zugstangen-, Kragenmutter Adapter Satz	326
1090-39	V2886	Hinterachsbuchsen Satz VW · AUDI · SEAT · ŠKODA	371
1090-39-06	V3213	Demontagehülse	371
1090-39-08	V3214	Montagehülse	371
1090-39-09	V3215	Montagering	371
1090-39-10	V3212	Demontagering	371
1090-54-01	V3045	Druckhülse	370
1090-54-02	V3046	Druckhülse	370
1090-54-03	V3047	Druckhülse	370
1090-54-04	V3048	Montagehülse	370
1090-54-05	V3049	Demontagering	370
1090-54-06	V2915	Traggelenk-Demontagehülse MERCEDES-BENZ	370
1090-54-10	V2913	Traggelenk Satz MERCEDES-BENZ	370
1090-54-11	V2914	Stabilisator-Kugelgelenk Satz MERCEDES-BENZ	370
1090-54-12	V2917	Lenkerbuchsen Satz · hinten · MERCEDES-BENZ	372
1090-54-12-001	V3050	Demontagering	372
1090-54-12-002	V3051	Montagehülse	372
1090-54-12-003	V3052	Druckrohr	372
1090-54-12-004	V3044	Gegenhalterring Einbau	372
1090-55-C	V2858N	Pressbügel zum Wechsel von Traggelenken und Stabilisator-Kugelgelenken	403
1090-60-01	V3053	Platte mit Gewinde	350, 366, 369
1090-60-03	V3055	Stützbein	366
1090-60-04	V3056	Schraube · M 16x40 mm	350, 361, 366, 369
1090-60-05	V3057	Platte mit offener Seite	366
1090-60-06	V3142	Adapterplatte	366
1090-60-10	V3055-275	Stützbein Satz · 275 mm	367
1090-61-01	V2909	Druckstück für Traggelenk-Werkzeug	367
1090-61-02	V2908	Druckstück für Traggelenk-Werkzeug	367
1090-61-03	V2907	Druckstück für Traggelenk-Werkzeug BMW E 36 außen	367

Wallmek-No	VIGOR No.	Bezeichnung	Seite
1090-62-01	V2906	Druckstück für Traggelenk-Werkzeug BMW E 30 · E 36 innen · MERCEDES-BENZ 124	367
1090-62-02	V2905	Druckstück für Traggelenk-Werkzeug BMW E 30 · E 36 innen · MERCEDES-BENZ 124	367
1090-62-03	V2904	Druckstück für Traggelenk-Werkzeug BMW E 30 · E 36 innen	367
1090-62-08	V2903	Druckstück für Traggelenk-Werkzeug	355, 367
1090-64-01	V2902	Druckstück für Traggelenk-Werkzeug z.B. MERCEDES-BENZ 124	367
1090-66-01	V2901	Druckstück für Traggelenk-Werkzeug	355, 367
1090-66-03	V2900	Druckstück für Traggelenk-Werkzeug VW LT35	355, 367
1090-66-04	V2899	Druckstück für Traggelenk-Werkzeug NISSAN Interstar · OPEL Movano · RENAULT Master	355, 367
1090-66-05	V2898	Druckstück für Traggelenk-Werkzeug NISSAN Interstar · OPEL Movano · RENAULT Master · HYUNDAI Trajet · Santa Fé	355, 367
1090-66-06	V2897	Druckstück für Traggelenk-Werkzeug	355, 367
1090-66-07	V2896	Druckstück für Traggelenk-Werkzeug	367
1090-66-08	V2895	Druckstück für Traggelenk-Werkzeug	355, 367
1090-66-09	V2894	Druckstück Traggelenk-Werkzeug (Ausbau)	355, 367
1090-66-10	V2893	Druckstück für Traggelenk-Werkzeug	355, 367
1090-68-01	V2892	Druckstück für Traggelenk-Werkzeug	367
1090-68-02	V2891	Druckstück für Traggelenk-Werkzeug	367
1090-69-20-B	V5902	Hinterachsbuchsen Satz	350, 371
1090-69-21	V3100	Demontage- / Montagehülse	371
1090-69-22	V3101	Montagescheibe	371
1090-69-23	V3102	Gegenhalterring	371
1090-69-24	V3103	Druckscheibe	371
1090-69-25	V5902-1	Montagehülse	371
1090-69-26	V5902-2	Halterring	371
1090-69 1090-60-06	V2885	Press-Stativ mit offener Platte mit Adapter um Platte zu schließen	355, 366
1091-10	V2879	Radlager Satz · vorne FORD	398
1091-10-04	V3088	Nabenscheibe · Innen-Ø 23 mm · passend für M 22 Spindel	401
1091-11	V3087	Nabenwerkzeug	401
1091-15-01	V3090	Adapterring	402
1091-17	V2889	Radlager Satz · vorne · CITROËN · FIAT · PEUGEOT	396
1091-17-01	V3105	Druckring	396
1091-17-02	V3106	Druckscheibe Ø 170 mm	396, 400–401, 413
1091-17-03	V3107	Druckrohr	396, 413

Wallmek-No	VIGOR No.	Bezeichnung	Seite
1091-17-04	V2881	Lagerscheibe für CITROËN · FIAT · PEUGEOT Radlager Satz · vorne · Innen-Ø 23 mm · passend für M 22 Spindel	396, 401
1091-17-05	V3108	Lagerscheibe · Innen-Ø 23 mm · passend für M 22 Spindel	396, 400–401
1091-17-06	V3109	Gegenhalter	396, 401
1091-17-07	V2882	Nabenscheibe für CITROËN · FIAT · PEUGEOT Radlager Satz · vorne	396, 401
1091-17-08	V3149	Druckrohr	396, 400–401
1091-17-09	V3091	Nabenscheibe · Innen-Ø 23 mm · passend für M 22 Spindel	396, 401
1091-17-M22	V3092	Schlagmutter	324, 408
1091-18	V2883	Druckring für Radlager Satz · vorne · CITROËN · FIAT · PEUGEOT	396–397, 401
1091-23-03	V3110	Druckscheibe · Ø 89 mm	401
1091-28	V2890	Antriebswellen-Werkzeug 5-Loch für Transportfahrzeuge	399, 402
HSC2008-1116	V4353	Federteller Ø 150 – 240 mm	377
HSC2008-1117	V4352	Federteller Ø 70 – 160 mm	377
HSC2008-1118	V4354	Federteller Ø 150 – 240 mm mit Arretierung	377
HSC2008-1119	V4476-1	Adapter-Ring OPEL Insignia	377
HSC2018	V4476N	Hydraulischer Federspanner mit 10 Federteller	375
RES1030-01	V3614	Dichtungssatz	331
RES1030-02	V3120	2,2 m Hydraulikschlauch ¼"	331
RES1090-01-09	V3123	Druckfuß M 24x3 mm	323
RES1090-01-10	V3124	Druckstange · verstellbar M 24	322–323
RES1090-01-12	V3129	Druckstück · verstellbar M 24	323, 355, 370
RES1090-01-13	V3125	Schutzring für Gewinde 1.½"	323
RES1090-02-04	V3134	Druckachse M 24x3 mm	323
RES1090-05-02	V3130	Druckstück · verstellbar M 24	323–324

Wallmek-No	VIGOR No.	Bezeichnung	Seite
RES1090-05-04	V3131	Schutzring für Gewinde 2,5	324
RES4009	V4596	Adapter · M 18 – M 22	326
RES4010	V3135	Adapter · M 22x2,5 – M 14x2,0	326, 372
RES4011	V3219	Adapter · M 22x2,5 – M 12x1,75	326, 373
RES4012	V3209	Adapter · M 22x2,5 – M 10x1,5	326
RES4014	V3210	Zugstange · M 10 · maximal 6 t	326
RES4015	V3220	Zugstange · M 12 · maximal 9 t	326, 373
RES4016	V3136	Zugstange · M 14 · maximal 12 t	326, 372
RES4021	V3137	Kragennutter · M 14x2,0	326, 372
RES4022	V3208	Kragennutter · M 12x1,75	326, 373
RES4023	V3275	Kragennutter · M 10x1,5	326
RES4024	V3126	Kragennutter · M 18x2,5	323, 326, 329, 363, 412
RES4025	V3132	Kragennutter · M 22x2,5	324, 326, 408
RES4026	V3127	Zugstange · M 18 M 22 · maximal 22 t	323, 326, 412
RES4027	V3133	Zugstange · M 22 · maximal 32 t	324, 326
RES4030	V3140	Zugstange M 18	363
RES4034	V3431	Zugstange · M 22	408, 413
RES4035	V4252	Kragennutter M 27	324
RES4036	V4253	Zugstange · M 27 · maximal 50 t	324
RES4039	V4597	Adapter · Innengewinde: M 22x2,5 mm · Außengewinde: M 27x3,0 mm	326
RES4042	V7699	Spindel M22 · M20	326
RES4043	V7700	Kragennutter M20	326
RES4304	V3141	(CEJN-) Schnellkupplung	331
RES4305	V3012	CEJN-Nippel Hydraulik · 1/8 Zoll	322
RES4306	V3128	(CEJN-) Nippel Hydraulik ¼"	322–324
RES4307	V6591	Adapter 3/8" Außengewinde · auf CEJN / Zylinder	328
RES4308	V6592	Adapter 3/8" Innengewinde · auf CEJN / Pumpe	328





EINFACH VIGOR.



Sprechen Sie uns an:



K23/DE/CH/0 1.01.23/1. myView HZ-800/M6

Copyright 2023 by VIGOR GmbH

VIGOR GmbH · Am Langen Siepen 13-15 · D-42857 Remscheid · GERMANY · info@vigor-equipment.com · www.vigor-equipment.com

Alle Artikel nur solange der Vorrat reicht! Abbildungen können aus Darstellungsgründen vom Original abweichen und sind daher unverbindlich. Technische Änderungen vorbehalten. Keine Haftung für Druckfehler.